



ULTRA LOW TEMPERATURE FREEZERS

The most secure ultra-low temperature freezers for the storage of high value samples. Alongside exceptional ease-of-use and data monitoring, the Dual Cooling System provides the highest level of protection through the use of two independent refrigeration systems.

TwinGuard

Models:

MDF-DU302VX-PE | MDF-DU502VX-PE |

MDF-DU702VX-PE

MDF-DC500VX-PE | MDF-DC700VX-PE

ULTRA LOW TEMPERATURE FREEZERS



TwinGuard Upright Freezers

360 litres Freezers | 240 2"boxes

528 litres Freezers | 384 2"boxes

729 litres Freezers | 576 2"boxes

MDF-DU302VX-PE

MDF-DU502VX-PE

MDF-DU702VX-PE

TwinGuard Chest Freezers

575 litres Freezers | 416 2"boxes

715 litres Freezers | 520 2"boxes

MDF-DC500VX-PE

MDF-DC700VX-PE

The most secure ultra-low temperature freezers for the storage of high value samples

TwinGuard Ultra Low Temperature Freezers with Dual Cooling Technology offer the highest level of security for high-value samples. Alongside exceptional ease-of-use and data monitoring, the Dual Cooling System provides the highest level of protection through the use of two independent refrigeration systems. If one system unexpectedly fails, the other can maintain the freezer's temperature uniformly in the -70°C range. Developed for use with conventional inventory racks and boxes, the TwinGuard Series is ideal for storage of sensitive, high-value samples.



In the case of unexpected failure of one of the cooling circuits, the other circuit will maintain the freezer continuously in the -70°C range.

Scientific Applications

- Temperature sensitive samples such as therapeutics and biospecimens.
- Samples needing to retain viability such as stem cells, engineered tissue, organs, vaccines, hydromas, cancer cells or fibroblasts.
- Longitudinal study samples.
- Important medical research samples.
- Valuable pharmaceutical products.
- Clinical trial samples.
- Pathogenic samples within high security laboratories.

MEDICAL DEVICE DIRECTIVE

MDF-DU302VX, MDF-DU502VX, MDF-DU702VX
MDF-DC500VX and MDF-DC700VX Freezers are certified as a Class IIa Medical Device (93/42/EEC and 2007/47/EC) for medical purposes of storing human cells, organs, plasma and DNA.



Medical Device Directive

PHCbi has become one of the first companies in our industry to introduce Medical Device certification to underline our strong commitment to product design, quality and safety.

In 2010, PHCbi was awarded certification by TÜV-Süd to manufacture blood bank refrigerators, freezers and incubators as Class IIa Medical Devices according to the directives 93/42/EEC and 2007/47/EC. At the same time our quality systems were updated to the latest ISO9001 and ISO13485 standards.

The use of refrigeration products and cell culture incubators for the preservation and cultivation of cells and tissues for human use in transfusion, regenerative medicine and cell therapy is set to expand.





TwinGuard ULT Freezers



LCD touch panel on **TwinGuard** chest freezers



LCD touch panel on **TwinGuard** upright freezers

ULTIMATE SAMPLE PROTECTION

The Dual Cooling System offers the highest level of protection through the use of two independent refrigeration systems. If one system unexpectedly fails the other can maintain the freezer in the -70°C range.

ENHANCED USE & INTELLIGENT SECURITY

The freezers are managed and monitored by an integrated microprocessor controller with a comprehensive alarm system and diagnostic functions. Status and control of parameters are accessible via an LCD information centre. The EZlatch, on the upright models, makes access to stored samples even easier. A colour LCD touch panel allows full user control, even with gloved hands, while the USB port makes transferring logged data to a PC convenient.

FILTERLESS DESIGN

The filterless construction of the freezers reduces routine maintenance time by eliminating the need for regular cleaning of filters.

TEMPERATURE SENSITIVITY

Securely store valuable and irreplaceable samples with the upmost confidence. Exceptional uniformity and greatly reduced risk of sample degradation as a result of temperature fluctuation during freezer failure.

SUPERIOR FOOTPRINT

VIP PLUS vacuum insulation provides up to 30% more storage capacity than a conventionally insulated freezer, without increasing the footprint. A glass fibre core provides advanced thermal properties and therefore outstanding energy efficiency, whilst delivering exceptional cooling performance and durability for storing valuable research and clinical samples.

- Advanced cabinet insulation technology for increased energy efficiency and cooling performance.

SAMPLE PROTECTION & OPTIMUM CAPACITY

Models: MDF-DU302VX-PE | MDF-DU502VX-PE | MDF-DU702VX-PE | MDF-DC500VX-PE | MDF-DC700VX-PE

DUAL COOLING SYSTEM

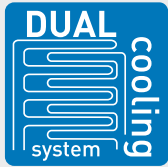

Within *TwinGuard*'s independent Dual Cooling System, efficient ultra-low cooling is achieved through two independent evaporator circuits surrounding the interior chamber.

VIP PLUS INSULATION



VIP PLUS vacuum insulation provides up to 30% more storage capacity than a conventionally insulated freezer, without increasing the footprint. A glass fibre core provides advanced thermal properties.

Two independent evaporator circuits

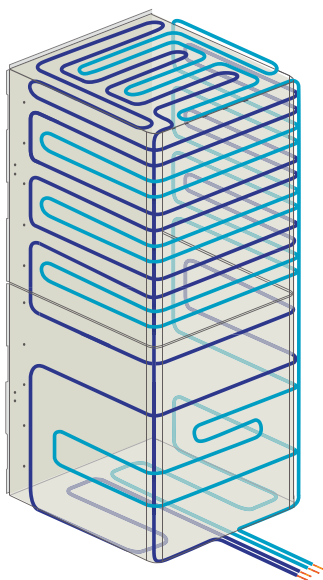

Dual Cooling System Upright freezers



- The Dual Cooling System offers the highest level of security through the use of two independent refrigeration systems. If one system unexpectedly fails the other can maintain the freezer at the -70°C range.

Innovative design

PHCbi was the first company to introduce vacuum insulation panels to ultra-low temperature freezers. The range of ULT freezers with VIP (PLUS) Insulation typically provide 30% more storage capacity for a given floor area saving valuable laboratory space. The patented VIP vacuum insulation panel thin-wall composite is a high-efficiency design that yields more interior storage volume in a conventional freezer footprint.

Which freezer will you choose?

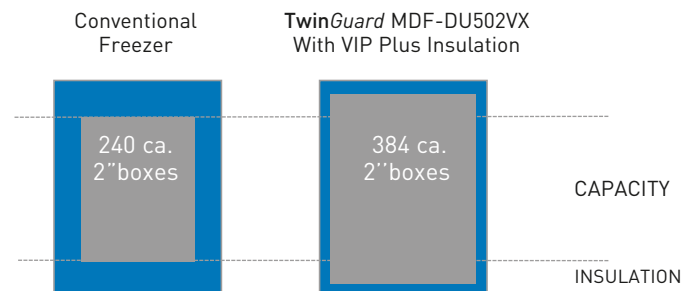

TEMPERATURE UNIFORMITY

Uneven interior temperatures can lead to a loss in sample integrity. *TwinGuard* freezers with uniform, stable temperatures and quick recovery times provide the best protection for your samples, ensuring reliable preservation while guarding against degradation.

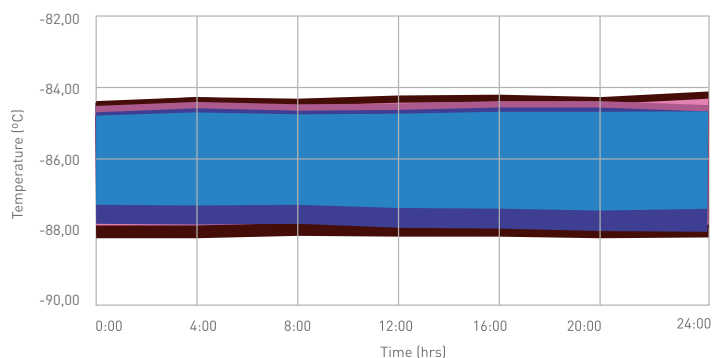

MDF-DU702VX; 9 POINT TEMPERATURE MAPPING

SAMPLE PROTECTION

Models: MDF-DU302VX-PE | MDF-DU502VX-PE | MDF-DU702VX-PE | MDF-DC500VX-PE | MDF-DC700VX-PE

- Each refrigeration circuit includes a closed-loop cold-wall evaporator configured in parallel to the other.
- If a component, such as a compressor, fails in a conventional ULT freezer with single or cascade refrigeration circuits with mutually dependent high and low stage systems, the whole system will fail and the freezer will eventually rise to room temperature, putting samples at serious risk of degradation.
- Independent compressors, evaporators and cooling fans in *TwinGuard* freezers ensure back-up status at all times, eliminating system failure due to failure of a component.
- An unique ECO mode deploys both systems in overlapping cycles to maintain -86°C and to reduce energy consumption.
- Evaporator coils embedded in the patented, high-tech, VIP PLUS vacuum-insulated thin-wall cabinet are strategically oriented to deliver the best temperature uniformity throughout the freezer at all times, even if only one system is active.
- The compressors, that are specifically designed for ultra-low temperature applications, feature innovative refrigerant feedback processes to reduce compressor temperature, thereby extending compressor life and minimizing heat output.

Two independent refrigeration systems

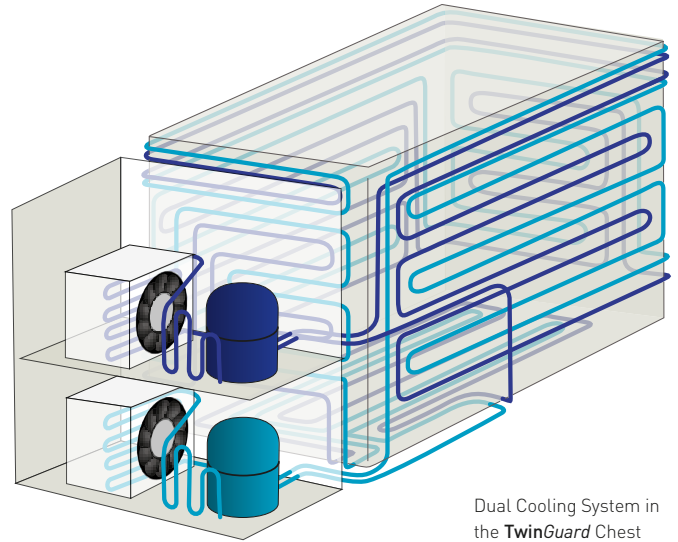

Dual Cooling System in the *TwinGuard* Chest Freezers

Discover the Dual Cooling -86°C Refrigeration System

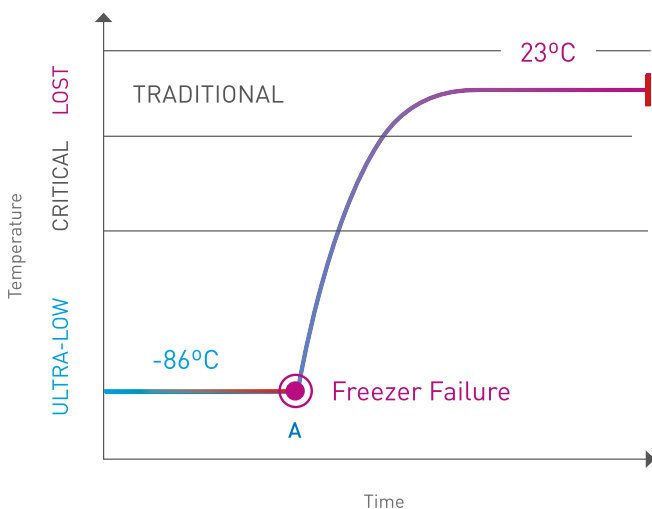

PERFORMANCE DATA CONVENTIONAL FREEZERS
IN CASE OF COMPRESSOR FAILURE.

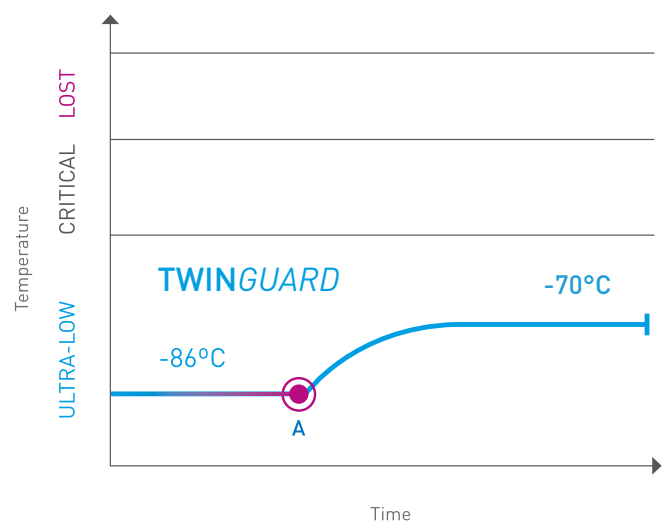

PERFORMANCE DATA **TWINGUARD** FREEZERS
IN CASE OF COMPRESSOR FAILURE.

Models: MDF-DU302VX-PE | MDF-DU502VX-PE | MDF-DU702VX-PE | MDF-DC500VX-PE | MDF-DC700VX-PE



INDUSTRY FIRST INTELLIGENT ECO MODE OPERATION

The *TwinGuard* ULT Freezers can be set to Normal or ECO mode operation, depending on the requirements of the user. Although both refrigeration systems are completely independent, ECO mode establishes an overlapping cycle to significantly reduce energy consumption while maintaining optimum interior uniformity for protection of high value materials.

Normal mode maintains the most repeatable, cycling wave form for the strictest of GMP applications.

ECO MODE OPERATION IMAGE

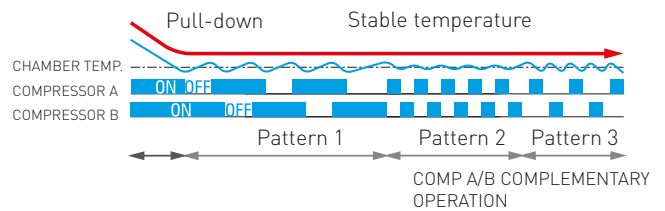

NORMAL MODE OPERATION IMAGE

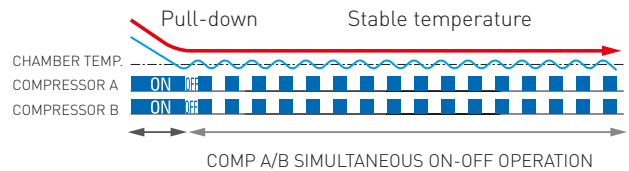

Status	System A and B ON	System A and B ON, Cycling On/Off	System A and B ON, Cycling On/Off	System A ON	System B ON
Function	Maximum Pull-Down and Recovery Capacity	ECO mode	Normal Mode	Back-Up for System B	Back-Up for System A
Performance	Establishes highly uniform -86°C storage temperature; maximizes recovery following door openings and heat load additions in ECO and Normal Mode.	Maintains better energy management at high or low ambient temperatures as well as excellent top-to-bottom uniformity.	Maintains excellent top-to-bottom uniformity. Maintains most repeatable, cycling wave form for the strictest of GMP applications.	Maintains in the -70°C range.	Maintains in the -70°C range.

CABINET CONSTRUCTION

Models: MDF-DU302VX-PE | MDF-DU502VX-PE | MDF-DU702VX-PE



- 1 Multiple access ports permit insertion of independent probes, instrumentation or liquid CO₂ back-up injectors.
- 2 The EZlatch door handle makes access to stored samples even easier.
- 3 An automatic vacuum release port allows smooth door opening when a vacuum has been formed due to the large different in ambient and chamber temperature during previous door opening.
- 4 A manual vacuum release port allows smooth door opening in case of unexpected failure of the automatic vacuum release port.
- 5 Gasketed inner doors seal inside to offer additional protection, improve uniformity. Inner door latches are standard.
- 6 Temperature recorder (optional) mounts easily in pre-engineered mounting space.
- 7 The compressors are specifically designed for ultra-low temperature applications.
- 8 High impact, recessed casters and leveling feet simplify installation.
- 9 A colour LCD touch panel allows full user control, even with gloved hands, while the USB port makes transferring logged data to a PC convenient.
- 10 Innovative cabinet design with chamfered edges reduces footprint for use in multi freezer laboratories.

Various alarms including high/low temperatures, door ajar, power failure alarm and part replacement notification keep samples safe even in an emergency.

Innovative cabinet design with chamfered edges, ideal for use in multi freezer laboratories

INNOVATIVE CABINET DESIGN

The innovative cabinet design with chamfered edges reduces footprint for use in multi freezer laboratories.

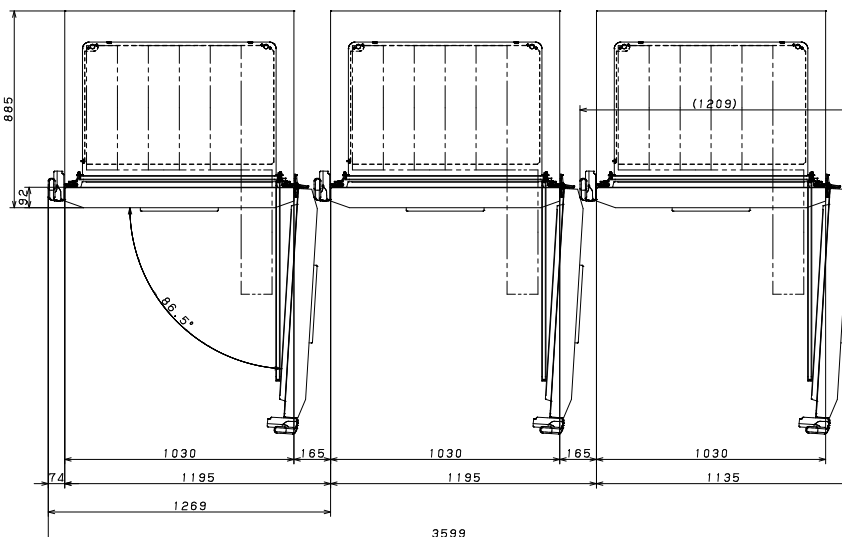



MDF-DC500VX-PE, MDF-DC700VX-PE

MICROPROCESSOR CONTROL WITH TOUCH SCREEN DISPLAY

The *TwinGuard* ULT Freezers are managed by an integrated microprocessor controller with LCD touchscreen to simplify all freezer functions. Uniform ultra-low temperature is achieved through a combination of performance systems supervised by the controller complete with alarm, programming and diagnostic protocols. The built in USB port allows logged data to be easily transferred to a PC.

Touch Panel Legend

1. **Present temperature display field:**
The current chamber temperature is displayed.
2. **Set temperature value display field:**
The set value of chamber temperature is displayed.
Default setting: -80 °C.
3. **Message display field:**
Alarms, errors or messages are displayed when a fault occurs.
4. **Control display:**
The present operation control mode is displayed.
Normal control: "Normal" is displayed.
Eco control: "ECO" is displayed
5. **Alarm display:**
Normal condition: "Normal" is displayed.
Alarm-activated, buzzer-delayed: "Alarm" is displayed.
Alarm-activated, buzzer-sounding: "Warning" is displayed.
6. **Outer door (opening / closing display)**

MEETING YOUR FREEZER STORAGE NEEDS

An organized freezer will provide you with:

- **Time savings** - locate, retrieve and replace your samples easily and quickly.
- **Cost savings** - organized samples and cell lines can help to reduce the number of freezers.
- **Added sample security and energy savings** - samples are better protected and are less exposed to ambient temperatures as door opening times can be reduced when placing and retrieving samples, which also reduces energy use.

For an overview of the racks designed for the *TwinGuard* series see backpage

FLEXIBLE SHELF LAYOUT

Multiple shelf configurations in the upright models allow a variety of storage options. Organize your samples by using your existing inventory racks or select from the many different rack types we offer.

PHCbi's racks are made of stainless steel or anodized aluminum. The aluminum racks are very light, yet sturdy and corrosion free.

- High quality racks – designed for safe working and easy access to samples.
- Affordable solutions – making freezer storage cost-effective as well as space-efficient.
- Large selection of products – additional rack types and boxes are available on request.

SPECIFICATIONS

		TwinGuard Upright Freezers			TwinGuard Chest Freezers	
Model Number		MDF-DU302VX-PE	MDF-DU502VX-PE	MDF-DU702VX-PE	MDF-DC500VX-PE	MDF-DC700VX-PE
Dimensions						
External Dimensions (W x D x H) ¹⁾	mm	670 x 882 x 1840	790 x 882 x 1993	1030 x 882 x 1993	2010 x 845 x 1070	2300 x 845 x 1070
Internal Dimensions (W x D x H)	mm	490 x 600 x 1230	630 x 600 x 1400	870 x 600 x 1400	1190 x 640 x 756	1480 x 640 x 756
Volume	litres	360	528	729	575	715
Capacity	2" boxes	240	384	576	416	520
Net Weight (approx)	kg	225	276	320	328	358
Performance						
Cooling performance ²⁾	°C		-86		-86	
Temperature setting range	°C		-50 to -90		-50 ~ -90	
Temperature control range ²⁾	°C		-50 to -86		-50 ~ -86	
Control						
Controller		Microprocessor, non-volatile memory			Microprocessor non-volatile memory	
Display		LCD Touch Screen			LCD Touch Screen	
Temperature sensor		Pt-1000			Pt-1000	
Refrigeration						
Refrigeration system		Independent Dual-Cooling			Independent Dual-Cooling	
Compressor	W	2 x 450	2 x 1100		2 x 1100	
Refrigerant		MU-N302*	MU-N502*	MU-N702*	MU-NC500**	MU-NC700**
Refrigerant weight	g	340	510	555	515	550
GWP of refrigerant for each cooling circuit		6257	5313	5695	5139	5370
Total Refrigerant weight (CO ₂ equivalent)	t	4.255	5.420	6.322	5.293	5.907
Insulation material		PUF / VIP Plus			PUF / VIP PLUS	
Insulation thickness	mm	80			70 / 135	
Construction						
Exterior Material		Painted Steel			Painted steel	
Interior Material		Painted steel			Stainless steel	
Outer Doors/lid	qty	1			1	
Outer Door Lock		Y			Y	
Inner door/lid		2			3 (Styrofoam)	
Shelves	qty	3			-	
Max. load - per shelf	kg	50			-	
Max. load - total ³⁾	kg	356	415	515	-	
Vacuum release port		2 (1 automatic, 1 manual)			-	
Access Port	qty	3			1	
- position		back x 1, bottom x 2			Back	
- diameter	Ø mm	17			17	
Casters	qty	4 (2 leveling feet)			6 (3 levelling feet)	
Alarms (R = Remote Alarm, V = Visual Alarm, B = Buzzer Alarm)						
Power Failure		V-B-R			V-B-R	
High Temperature		V-B-R			V-B-R	
Low Temperature		V-B-R			V-B-R	
Filter		Filterless design			Filterless design	
Door open		V-B			V-B	
Electrical and Noise Level						
Power Supply	V	230			230	
Frequency	Hz	50			50	
Noise Level ⁴⁾	dB [A]	52			52	
Options						
Liquid CO ₂ back-up		MDF-UB7-PW			MDF-UB5-PW	
Liquid N ₂ back-up		N/A			N/A	
Temperature recorders						
- Circular type		MTR-G85C-PE ⁷⁾			MTR-G85C-PE	
- Chart paper		RP-G85-PW			RP-G85-PW	
- Ink pen		PG-R-PW			PG-R-PW	
- Continuous strip type		MTR-85H-PW ⁷⁾			MTR-85H-PW	
- Chart paper		RP-85-PW			RP-85-PW	
- Ink pen		PG-R-PW			DF-38FP-PW	
- Recorder housing		MDF-S3085-PW			MDF-S3085-PW	
Small inner door kit	set of 5	N/A	MDF-5ID5-PW ⁵⁾	MDF-7ID5-PW ⁶⁾	N/A	
Small inner door kit	set of 4	N/A	MDF-5ID4-PW	MDF-7ID4-PW	N/A	

Appearance and specifications are subject to change without notice.

¹⁾ Exterior dimensions of main cabinet only, excluding handle and other external projections

- See dimensions drawings on website for full details

²⁾ Air temperature measured at freezer centre, ambient temperature +30°C, no load

³⁾ Max. load is the total of the load distributed over all shelves (3) and chamber bottom surface.

The weight is the maximum load for chamber inside and excludes load on casters equipped with product.

⁴⁾ Nominal value. Background noise 20dB

⁵⁾ Usable storage capacity will be 320 x 2" boxes with installation of MDF-5ID5-PW and additional shelf

⁶⁾ Usable storage capacity will be 480 x 2" boxes with installation of MDF-7ID5-PW and additional shelf.

⁷⁾ Requires sensor cover MTR-DU700SF-PW.

* Complies with Art. 11, Annex III of F-G

Contains fluorinated greenhouse gases

** Complies with Art. 11, Annex III of F-gases in hermetically sealed equipment

This extended statement informs the user

greenhouse gases in quantities of 5 ton

require leak testing under the regulatic

MDF-DU302VX-PE - 360 LITRES

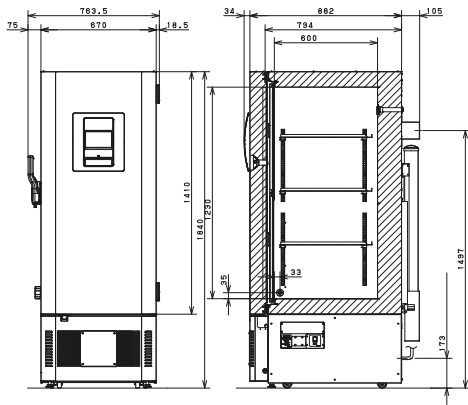

MDF-DU502VX-PE - 528 LITRES

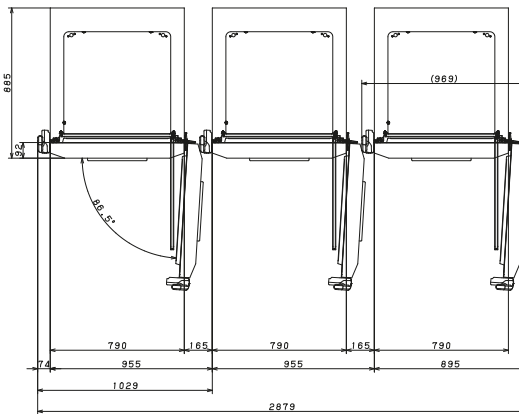
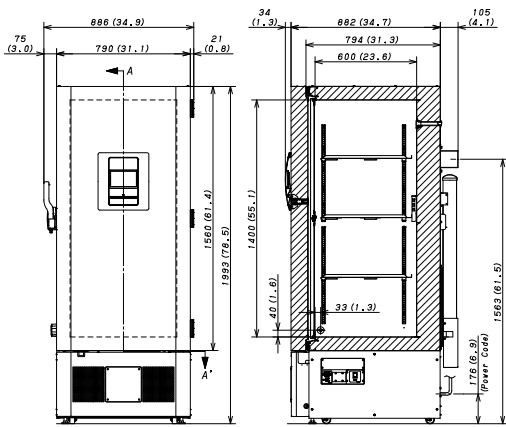

MDF-DU702VX-PE - 729 LITRES

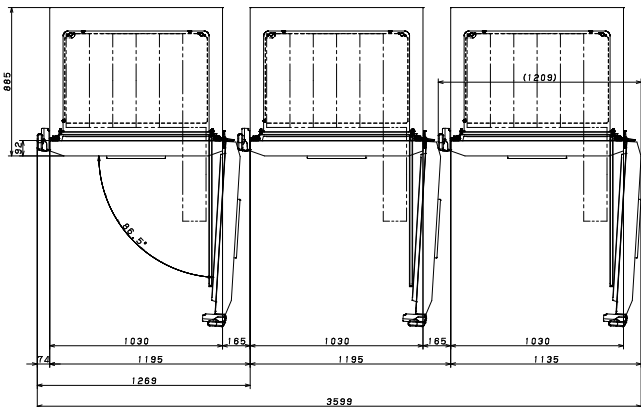
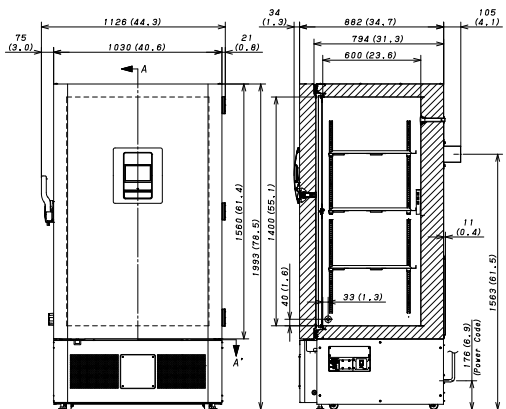

MDF-DC500VX-PE - 575 LITRES

MDF-DC700VX-PE - 715 LITRES

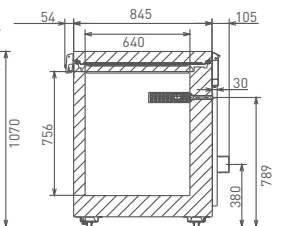
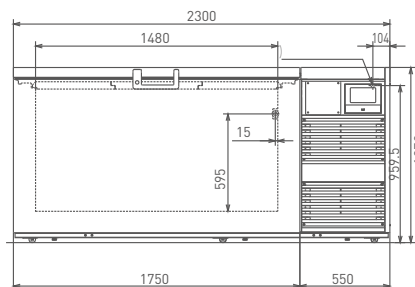
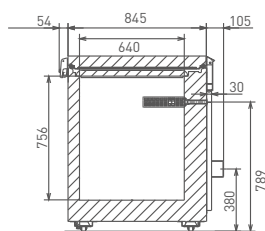
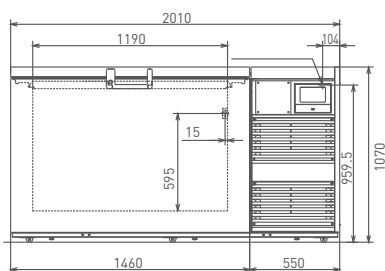

RACK CONFIGURATIONS

Models: MDF-DU302VX-PE | MDF-DU502VX-PE | MDF-DU702VX-PE | MDF-DC500VX-PE | MDF-DC700VX-PE

Vertical rack type	Box type	Rack/quantity Aluminium	Total boxes	Rack/quantity Stainless steel	Total boxes
MDF-DU302VX-PE					
with trays	(P) A1	12 x HCS-32-5584/143	240	2" Cardboard boxes 12 x SDR-524-N	240
side opening	(P) A1	12 x NIR-220U	240	2" Cardboard boxes 12 x SUR-524-N	240
with trays	(P) A2	12 x HCS-32-3804/143	144	3" Cardboard boxes 12 x SDR-334-N	144
side opening	(P) A2	12 x NIR-312U	144	3" Cardboard boxes 12 x SUR-334-N	144
MDF-DU502VX-PE					
with trays	(P) A1	4 x HCS-296	384		
with trays	(P) A1	16 x HCS-6564	384	2" Cardboard boxes 16x SDR-624-N	384
side opening	(P) A1	16 x NIR-224U	384	2" Cardboard boxes 16 x SUR-624-N	384
with trays	(P) A2	16 x HCS-4804	256	3" Cardboard boxes 16 x SDR-434-N	256
side opening	(P) A2	16 x NIR-316U	256	3" Cardboard boxes 16 x SUR-434-N	256
MDF-DU702VX-PE					
with trays	(P) A1	6 x HCS-296	576		
with trays	(P) A1	24 x HCS-6564	576	2" Cardboard boxes 24 x SDR-624-N	576
side opening	(P) A1	24 x NIR-224U	576	2" Cardboard boxes 24 x SUR-624-N	576
with trays	(P) A2	24 x HCS-4804	384	3" Cardboard boxes 24 x SDR-434-N	384
side opening	(P) A2	24 x NIR-316U	384	3" Cardboard boxes 24 x SUR-434-N	384
MDF-DC500VX-PE					
side opening	(P) A1	32 x NIR-213C	416	32 x SCR-132-N	416
side opening	(P) A2	40 x NIR-309C	288	32 x SCR-093-N	288
MDF-DC700VX-PE					
side opening	(P) A1	40 x NIR-213C	520	40 x SCR-132-N	520
side opening	(P) A2	40 x NIR-309C	360	40 x SCR-093-N	360

Appearance and specifications are subject to change without notice.

PERFORMANCE DATA MDF-DU302VX-PE

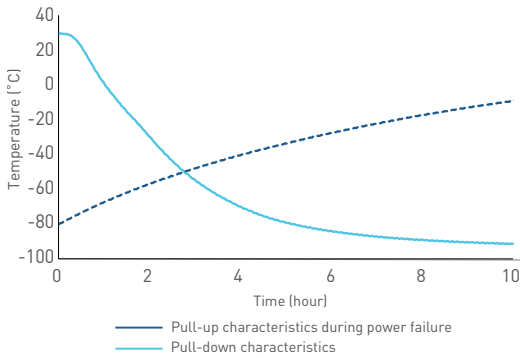

PERFORMANCE DATA MDF-DC500VX-PE

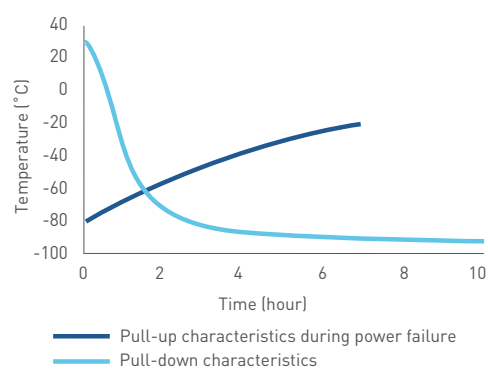

PERFORMANCE DATA MDF-DU502VX-PE

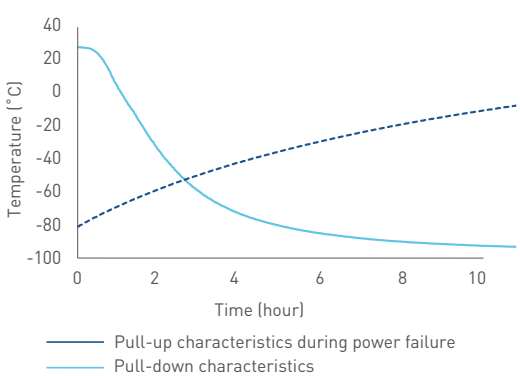

PERFORMANCE DATA MDF-DC700VX-PE

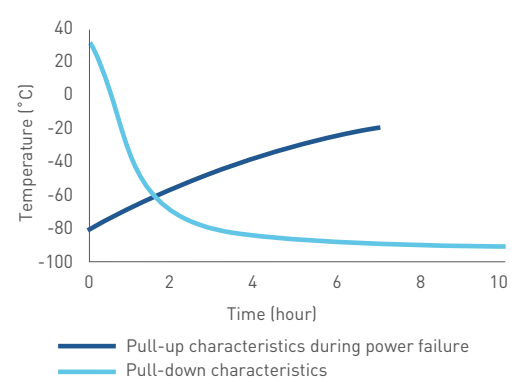

PERFORMANCE DATA MDF-DU702VX-PE

