

Smart Workflow, Faster Experiments

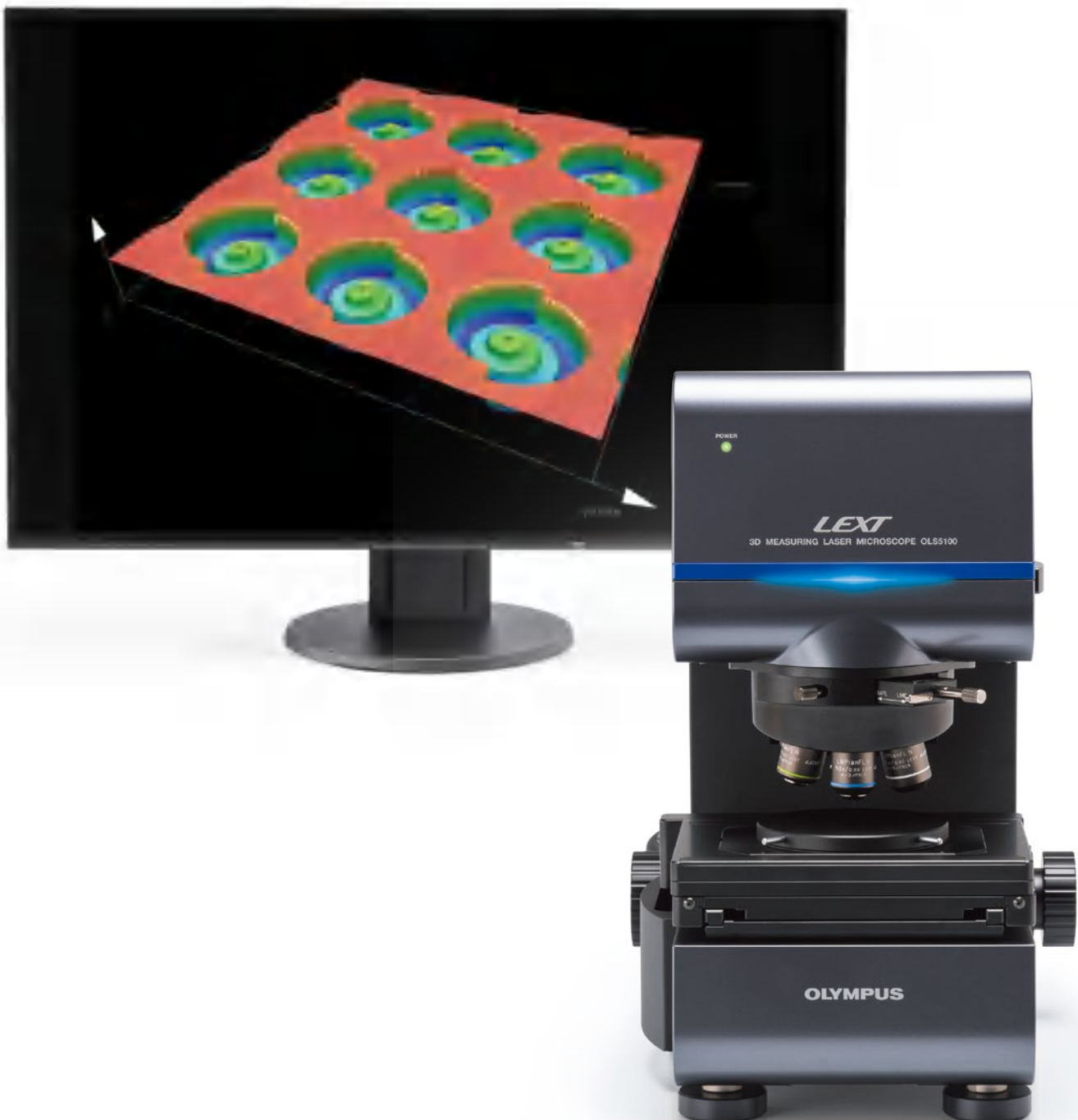



Practical Features for Efficient Experiments

The LEXT™ OLS5100 laser scanning microscope combines exceptional accuracy and optical performance with smart tools that make the system easy to use. The tasks of precisely measuring shape and surface roughness at the submicron level are fast and efficient, simplifying your workflow and delivering high-quality data you can trust.

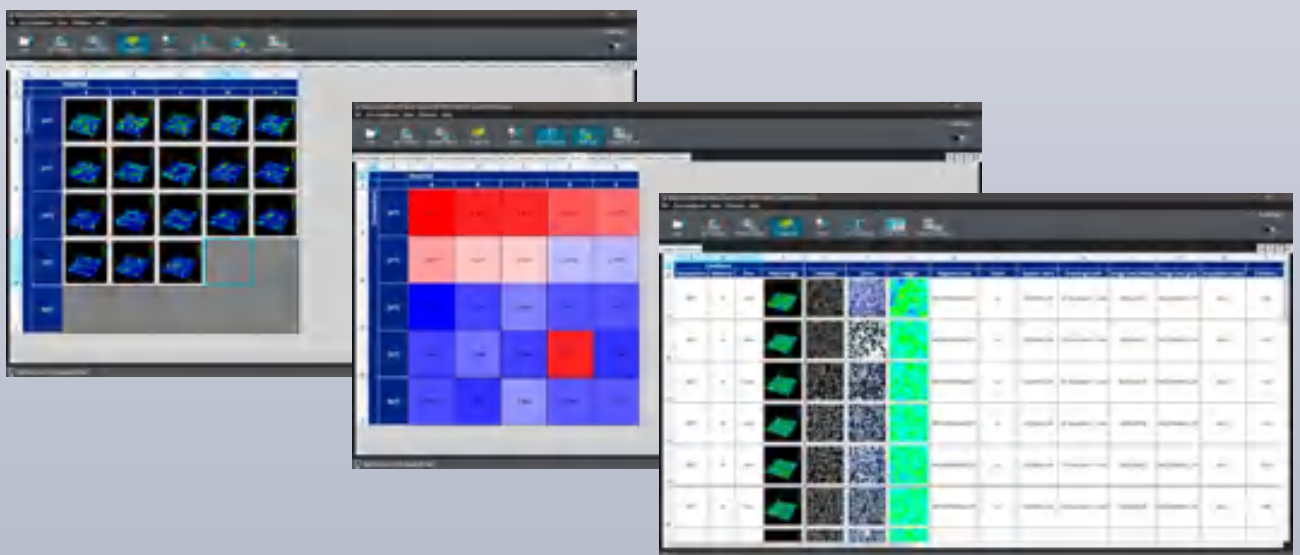

Simplify Your Measurement Testing Workflow

The LEXT OLS5100 microscope's Smart Experiment Manager* helps make your experiment workflow simpler by automating time-consuming tasks.

- Automatically creates your experiment plan
- Autopopulates data to your experiment plan matrix, reducing the chance of input errors
- Clear data trend visualization tools

*Requires the experiment total assist application OLS51-S-ETA.



Data You Can Trust

Objectives designed for LEXT microscopes deliver highly accurate data, enabling us to guarantee the microscope's measurement accuracy. Paired with the Smart Lens Advisor, you can acquire highly accurate data that you can be confident in.

- Dedicated LEXT optics optimized for the 405 nm wavelength of light reduce aberration to capture the correct shape of your same throughout the entire field of view
- Smart Lens Advisor helps you choose the right objective lens for your roughness measurement



Reliable Data at the Push of a Button

Using the microscope is easy for novice and experienced users thanks to thoughtfully designed software.

- Acquire accurate data easily—put your sample on the stage and press the start button
- Measurement performance guarantee tailored to your operating environment



Experience the Advantages of a Laser Microscope



Submicron 3D observation/ measurement

Observe steps in the nanometer range and measure height differences at the submicron level.

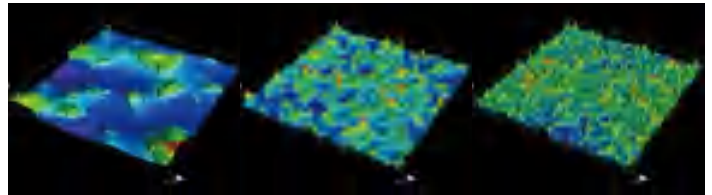

ISO25178-compliant surface roughness measurement

Measure surface roughness from linear to planar.

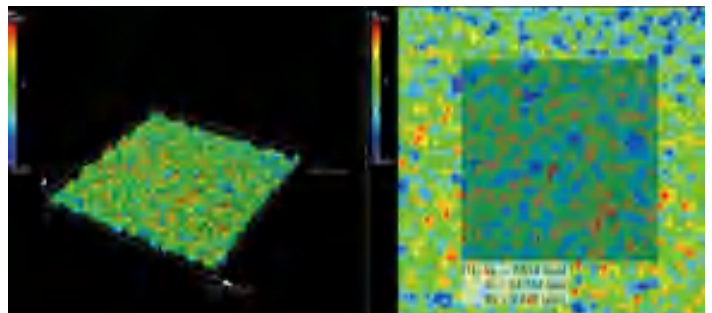

Noncontact, nondestructive, and fast

No sample preparation required—simply place the sample on the stage and you're ready to measure.



Conventional measuring tools

Optical microscope, digital microscope

Unable to measure small shapes

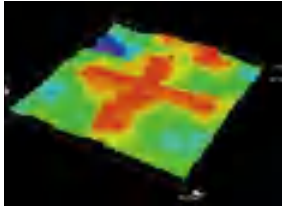

Poor lateral resolution

Non-traceable measurement results

Stylus surface roughness tester

Can damage the sample's surface

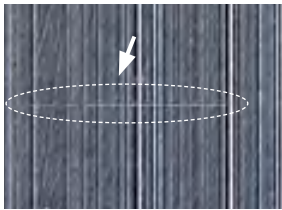

Information from only one line

Difficult to place the stylus on a target position

White light interferometer

Has difficulty capturing rough surface shapes



Poor lateral resolution makes positioning difficult

Inconvenient inclination adjustment

Scanning electron microscope (SEM)

No color information



Samples must be destroyed and prepared in advance

3D shape measurement is not possible

Laser microscope

Precision 3D measurement

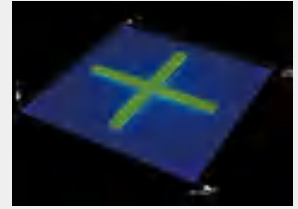

0.12 μm lateral resolution

Traceable measurement results

Noncontact measurement doesn't damage the sample



Acquire information from an entire plane

Pinpoint measurement

Captures small slopes for accurate surface roughness measurements

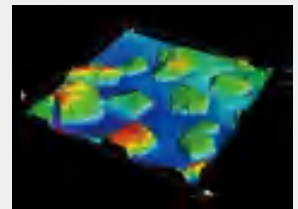

0.12 μm lateral resolution

Just place your sample on the stage to start measurement

High-definition color observation

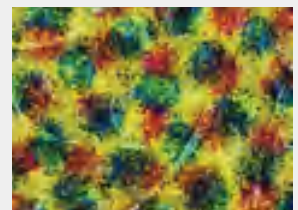

Nondestructive, and no sample preparation required

Precise 3D measurement

See pages 32–33 for details. ▶

LEXTM OLS5100 Laser Microscope Basic Principles

Configuration

The LEXT OLS5100 microscope has two optical systems—color imaging and laser confocal—that enable it to acquire color and shape information as well as high-definition images.

Color optics

The color imaging optics acquire information using a white-light LED light source and CMOS image sensor.

3D shape information and high-definition images

The laser confocal optics acquire confocal images using a 405 nm laser diode light source and a high-sensitivity photomultiplier. The shallow depth of focus enables it to measure a sample's surface irregularities.

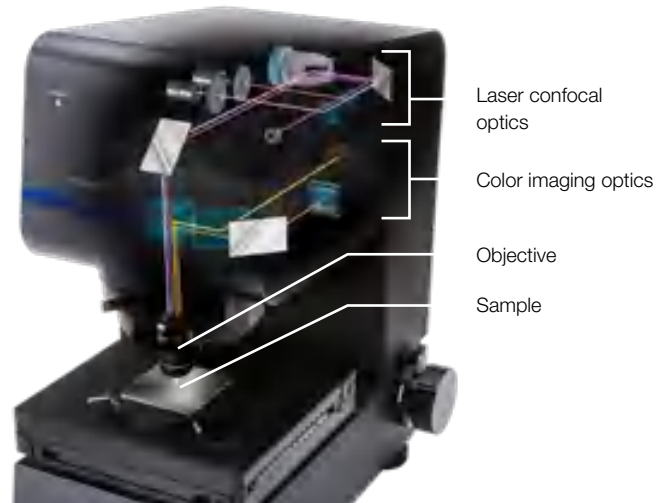

Configuration of the OLS5100 3D Measuring Laser Microscope

405 nm Laser Light Source

A laser microscope using a short-wavelength laser has better lateral resolution than a traditional microscope using visible laser light (peak value 550 nm). The OLS5100 microscope's 405 nm laser diode offers exceptional lateral resolution.

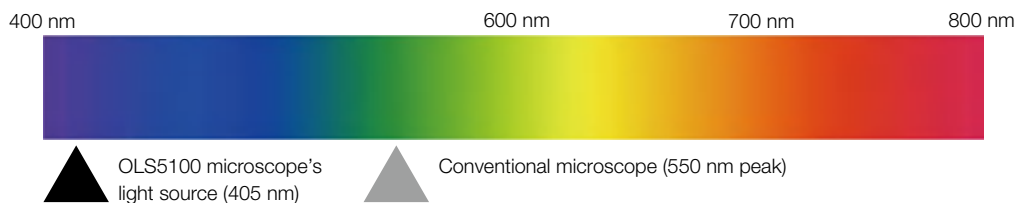

Laser Confocal Optics

The laser confocal optical system receives only the light focused through the circular pinhole, rather than capturing all the light reflected and scattered from the sample. This helps eliminate blur, making it possible to acquire an image with higher contrast than can be obtained with an ordinary microscope.

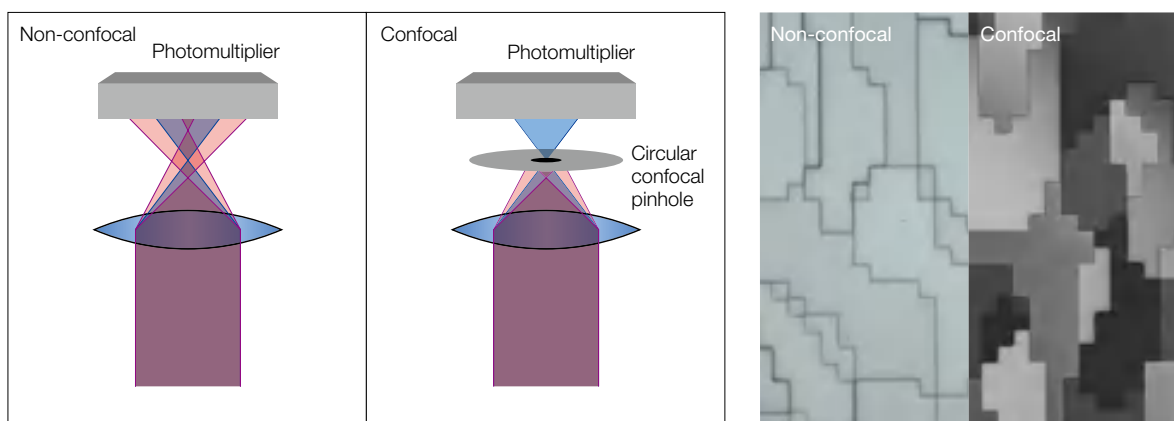

X-Y Scanner

The microscope's optical scanner integrates the X-axis, which uses an electromagnetic induction MEMS resonant scanner, and the Y-axis, which uses a Galvano scanner, so the X-Y scanner can be located in a coupled position with respect to the objective's pupil. The result is exceptional X-Y scanning with low scan trace distortion and fewer optical aberrations.

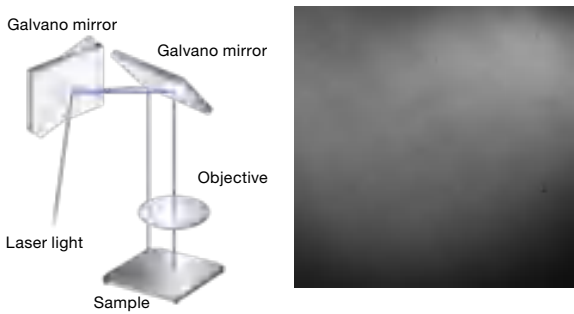

Conventional laser microscope (Proximal Galvano structure)

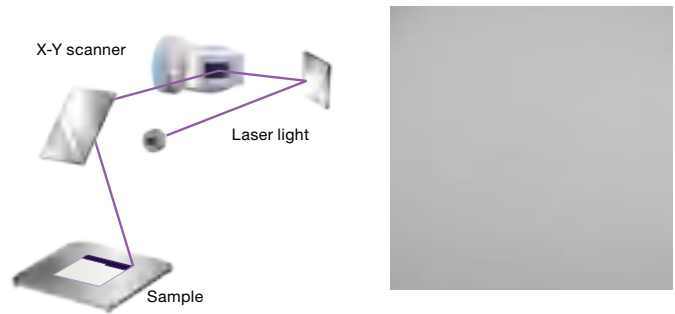

OLS5100 microscope (2-axis integrated structure)

Principles of Height Measurement

To measure height, the microscope acquires multiple confocal images by automatically shifting the focus position. Based on the discrete focus position (Z) and detected light intensity (I), the system estimates the light intensity variation curve (I - Z curve) for each pixel and obtains its peak position and peak intensity. Since the peak positions of all the pixels correspond to the sample's surface irregularities, it provides 3D shape information for the sample's surface. Similarly, the peak intensity data forms an image where all positions on the sample's surface are in focus (extended image).

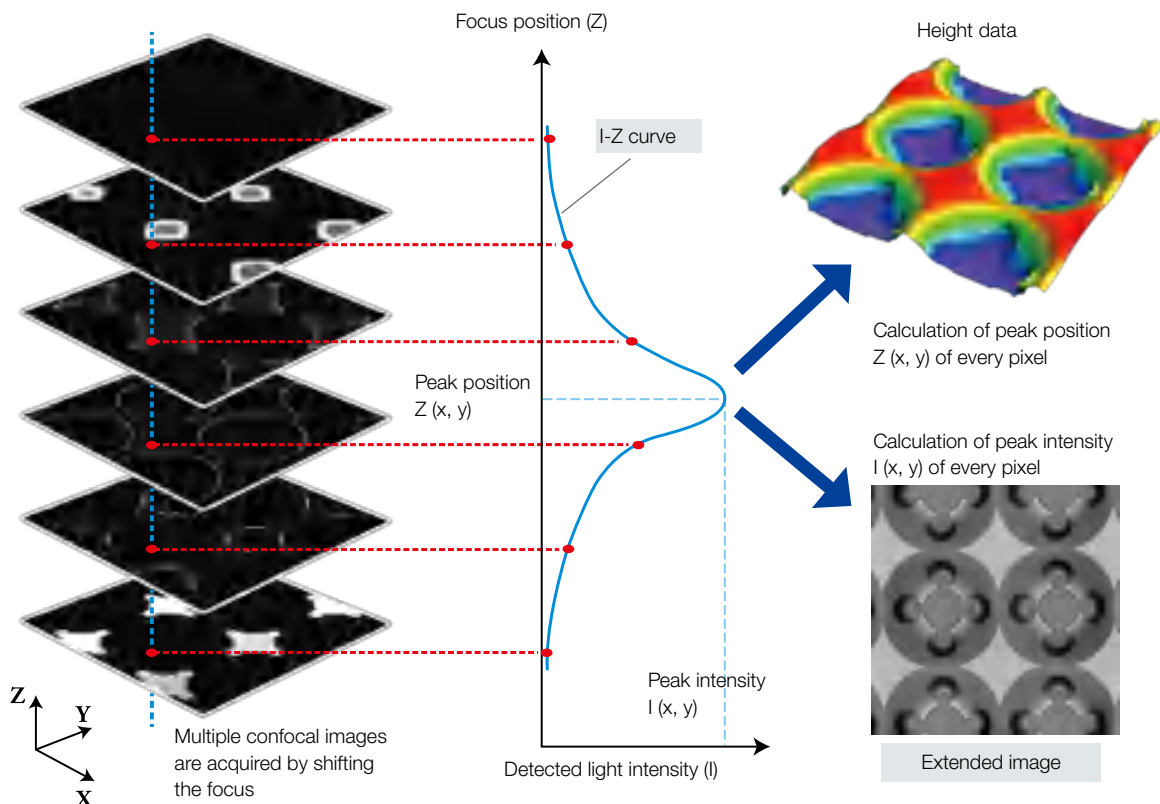

Principles of Height Measurement

Courtesy of KOSHIBU PRECISION CO.,LTD.

Practical Features for Efficient Experiments

Prepare and manage the experiment plan

Acquire data and analyze the measurement result trends

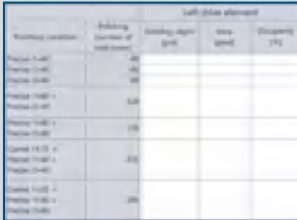

Position location	Adding	Number of	Measuring object	Area	Displacement (%)
Position 1 (m)	0.01	100	0.01	0.01	0.01
Position 2 (m)	0.02	200	0.02	0.02	0.02
Position 3 (m)	0.03	300	0.03	0.03	0.03
Position 4 (m)	0.04	400	0.04	0.04	0.04
Position 5 (m)	0.05	500	0.05	0.05	0.05
Position 6 (m)	0.06	600	0.06	0.06	0.06
Position 7 (m)	0.07	700	0.07	0.07	0.07
Position 8 (m)	0.08	800	0.08	0.08	0.08
Position 9 (m)	0.09	900	0.09	0.09	0.09
Position 10 (m)	0.10	1000	0.10	0.10	0.10

Prepare the experiment plan

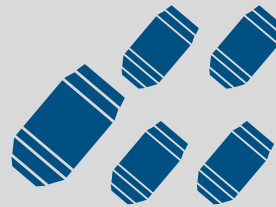

Specify the measurement conditions



Input the file name

It's difficult to choose the right lens for the application

The file name must clearly state the sample's characteristics and conditions for each measurement

3D Measuring Laser Microscope OLS510

Complete Your Measurement Tasks Up to 30% Faster

Managing experiment conditions when testing new materials is challenging and complicated, so we designed the Smart Experiment Manager to simplify this process by automating key steps, such as creating the experiment plan. And once your plan is created, the spreadsheet cells are autopopulated with data as it's acquired. You no longer have to waste time transcribing experiment information from your microscope system to your computer—the system does it for you.

Generate the final data set



Analyze data trends

Working condition	Building	Working days	Area	Frequency
Normal (A)	1	1	1.0000	100%
Normal (B)	2	2	2.0000	200%
Normal (C)	3	3	3.0000	300%
Normal (D)	4	4	4.0000	400%
Normal (E)	5	5	5.0000	500%
Normal (F)	6	6	6.0000	600%
Normal (G)	7	7	7.0000	700%
Normal (H)	8	8	8.0000	800%
Normal (I)	9	9	9.0000	900%
Normal (J)	10	10	10.0000	1000%

Generate your data set



It's easy to forget to capture data during the analysis, potentially requiring the experiment to be reworked

Up to
30%
faster*

*Compared with the previous model



Simplify Your Measurement Testing Workflow



Smart Experiment Manager

Do Your Work Quickly

Once you define the evaluation conditions, the Smart Experiment Manager saves you time by automatically creating the experiment plan. Then, just prepare your samples, put them on the stage, and press a button—the system does the rest.

Minimize Input Errors

Rather than manually inputting data into Excel cells, the software automatically adds values to your experiment plan matrix, reducing the chance of transcription errors that can lead to problems in the data. In just a couple of clicks, you can export your experiment data to an Excel spreadsheet.

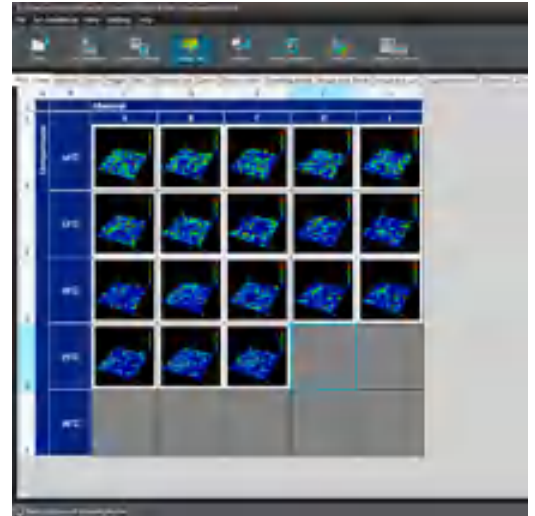

Easy Data Access and Organization

You can click on each cell in the experiment plan, and the software will automatically generate a file name that contains the evaluation conditions for easy record keeping. Each file contains the associated images and data.

	A	B	C	D
1	Conditions			
2	Temperature	Material	Time	
3	10°C	A	3min	
4	10°C	A	4min	
5	10°C	A	5min	
6	10°C	B	3min	
7	10°C	B	4min	
8	10°C	B	5min	

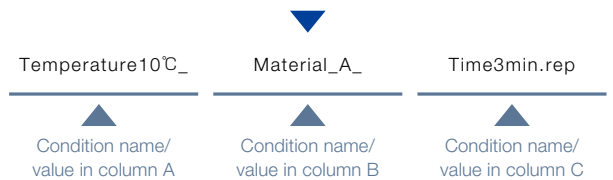

Spot Issues Early

The software displays a color map that helps you better understand the data being collected during your experiment. Intuitive chart layouts and heat maps enable rapid data visualization so that if there are any issues, they're easier to spot and correct early in the process.

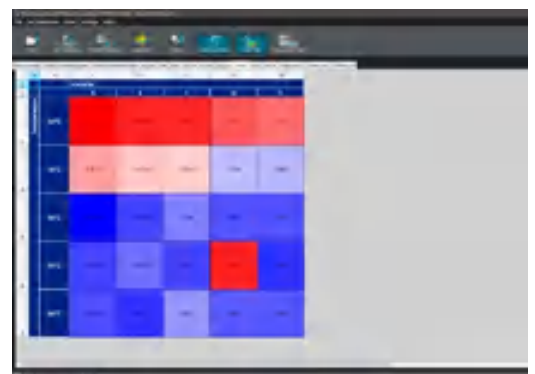



Objectives designed for LEXT™ microscopes deliver highly accurate data, enabling us to guarantee the microscope's measurement accuracy. Paired with the Smart Lens Advisor, you can acquire data that you can be confident in.

Smart Lens Advisor

To get accurate roughness measurements, it's important to use the right objective lens. But how do you know which one to choose? We made this process easier with the Smart Lens Advisor. Simply enter some basic information, such as the field of view and the lens you intend to use, and the Advisor will tell you how suitable your lens is to the application. Now you can be confident that you're using the right lens for the task.

Take the Guesswork Out of Lens Selection

In three easy steps, the Smart Lens Advisor takes the guesswork out of choosing the right objective lens for your roughness measurement. Determine your field of view, launch the Advisor, and press the start button—the software will tell you if the lens you selected is appropriate for your experiment.

Reduce the Chance of Redoing Work

The Smart Lens Advisor reduces the chance of using the wrong objective lens and having to run the experiment again with a different lens.

Determines the suitability of your lens in 3 steps

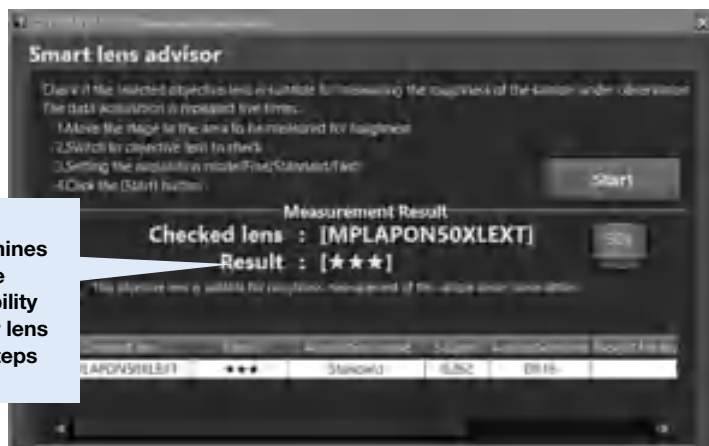

*Does not guarantee the measured value

Dedicated LEXT Objectives

Olympus offers a line of 10x to 100x objectives capable of reducing aberrations at a scale of 405 nm. Low power and long working distance objectives are also available in this series. The measurement performance of all dedicated LEXT objectives is guaranteed, so you can select the one best suited to the sample you're observing.

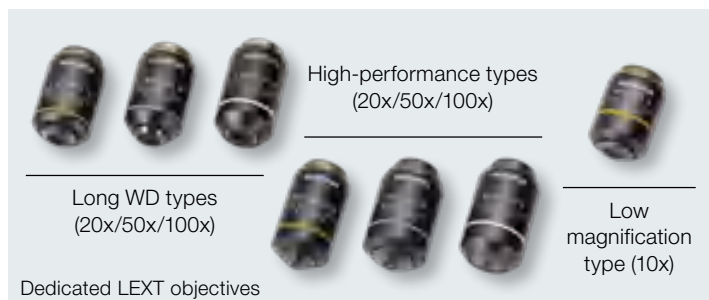

Conventional lenses have difficulty making accurate measurements in peripheral areas.

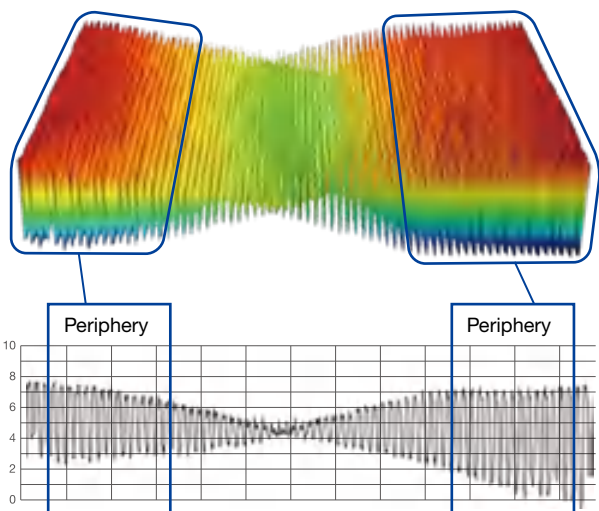

Distortion increases at the periphery.

Dedicated LEXT objectives accurately measure peripheral areas.

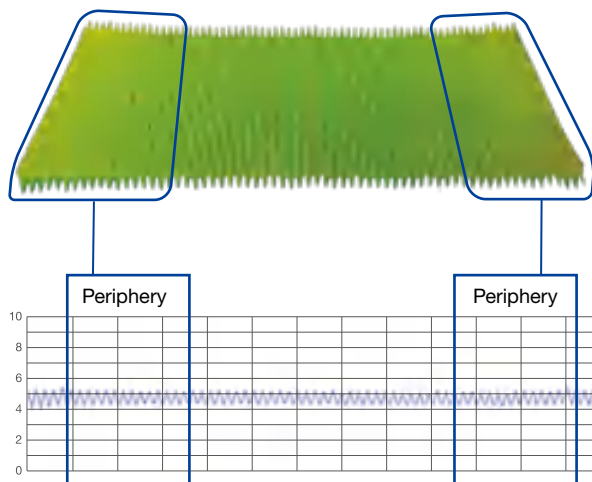

The periphery is reproduced free of distortion.

Advanced Features

Excellent Lateral Resolution

The 405 nm violet laser and dedicated high-NA objectives make it possible to capture fine patterns and defects that conventional optical microscopes, white-light interferometers, or red laser-based microscopes are unable to detect.

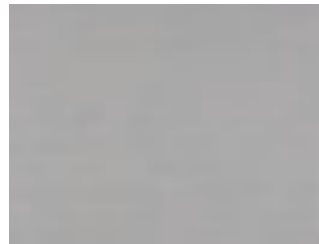

Red laser
(658 nm: 0.26 μm line & space)

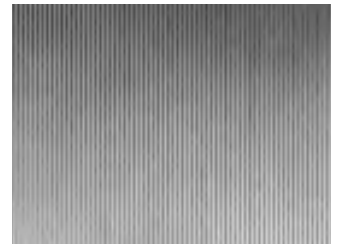

Violet laser
(405 nm: 0.12 μm line & space)

MEMS Scanner

Our MEMS scanner performs accurate X-Y scanning with low scan trace distortion and minimal optical aberrations. While some laser microscopes are prone to measurement fluctuations in peripheral areas, the OLS5100 microscope obtains uniform results regardless of whether its making measurements at the center or periphery of the visual field.



MEMS scanner

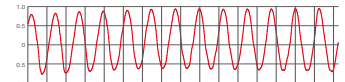
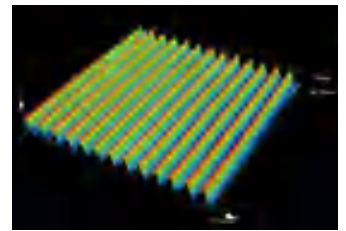

Standard roughness sample 528 by Rubert & Co., Ltd. ($P_t=1.5 \mu\text{m}$)(MPLAPON20XLEXT)



4K Scan Technology

The microscope scans 4,096 pixels—four times more than a conventional system—in the X-axis direction. 4K scanning improves measurement reliability in the height direction and enhances the resolution—the signal-to-noise ratio is improved by a factor of two. The microscope can detect near-vertical slopes as well as very low steps without image correction.

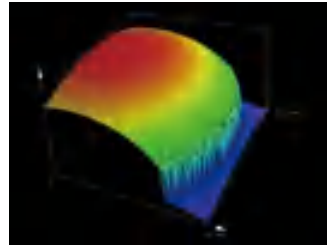

Detecting the surface of an 87.5° slope (MPLAPON50XLEXT)

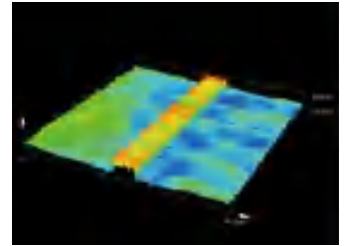

Standard 6 nm height sample by the National Metrology Institute of Germany (MPLAPON20XLEXT)

Dual Confocal System

The microscope has two channels of confocal optics with different pin-hole diameters. The optimum channel is selected according to the lens type and data acquisition mode, enabling reliable data to be acquired.

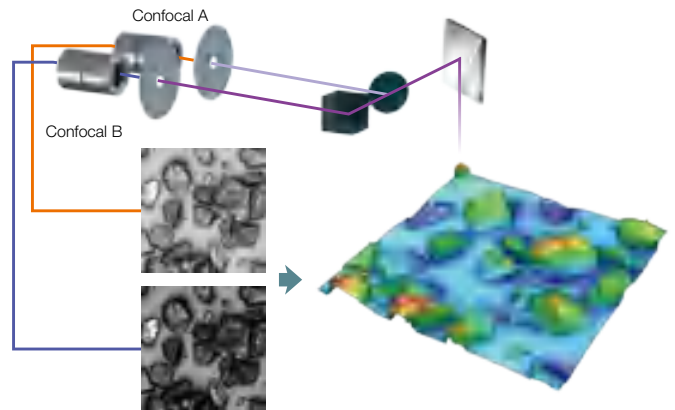

Sq Noise (Measuring Noise) Guarantee

Sq noise is a quantization of the height detection resolution of a measuring tool. The OLS5100 microscope guarantees that the measurement conforms to ISO25178-700. The measuring noise is 1 nm[†] with MPLAPON 100X LEXT objectives.

† You will receive an Sq noise guarantee certificate. This is a representative value when measured under conditions specified by Olympus and is different from the guaranteed value.

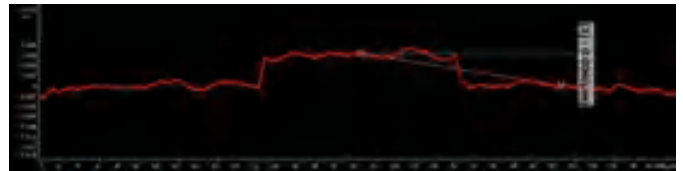

6 nm height sample by the National Metrology Institute of Germany (MPLAPON100XLEXT)

Smart Judge Function

Conventional laser microscopes use image processing techniques, like smoothing, to eliminate noise, but fine height irregularities can be filtered out along with the noise for less accurate data. The OLS5100 microscope's Smart Judge algorithm automatically detects only the reliable data, delivering accurate measurements without losing fine height irregularity data.

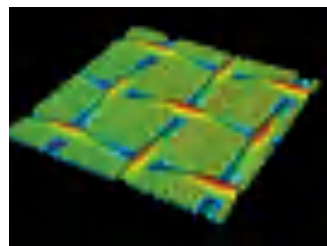

Smart Judge off



Smart Judge on

Reliable Data at the Push of a Button



Easy to Use with Little Training

Experienced and novice users alike can acquire data quickly and easily with the Smart Scan II feature. Place the sample on the stage, press the start button, and the microscope does the rest.

Fast, Accurate Measurements

The OLS5100 microscope's PEAK algorithm provides fast, precise measurements at both low and high magnification for 3D data reconstruction and a data acquisition speed four times faster than conventional laser microscopes.

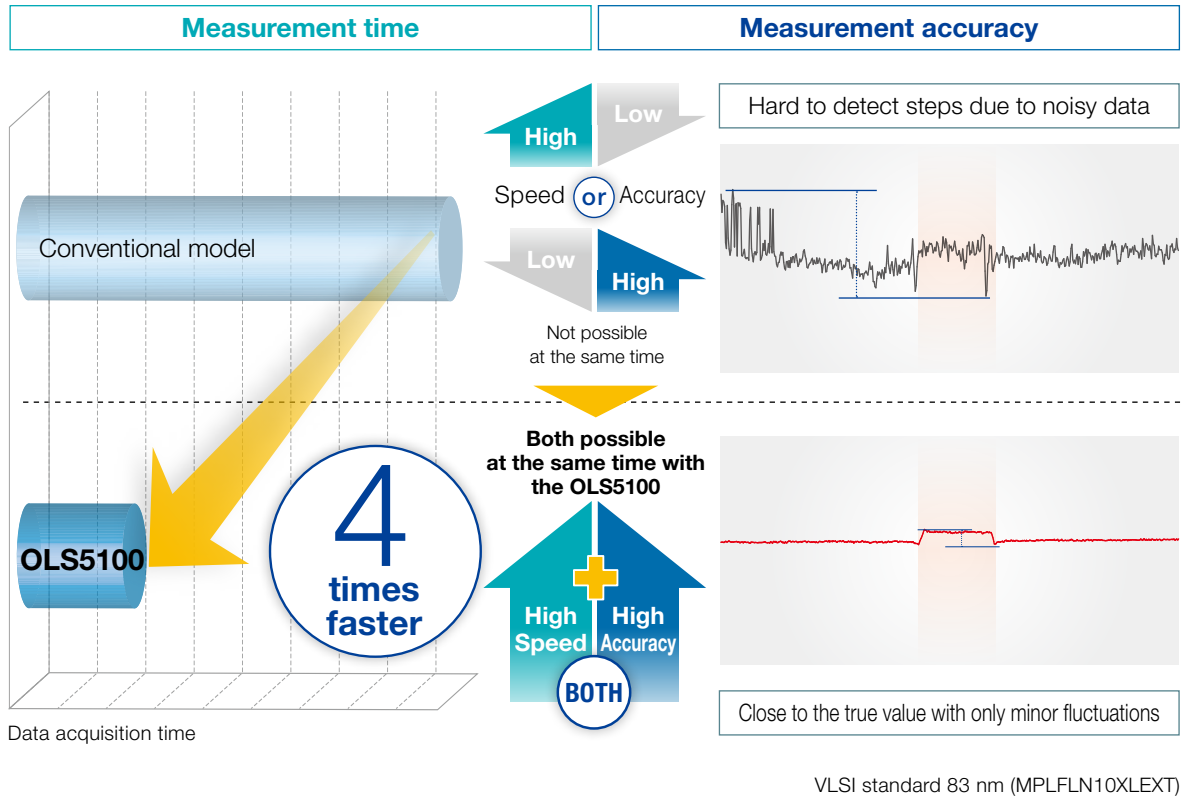

Measurement performance guarantee tailored to your operating environment

With any measuring tool, it's critical that it provides optimal measurement performance in the operating environment where it's used. If the tool's performance is only guaranteed at the factory where it's made, it may not provide the same results when it's installed. To make sure you get the performance you need, our engineers assemble, adjust, and calibrate the microscope in your facility where it's going to be used. The calibration certificate and examination results are issued only after the microscope is installed, so you can use the system with confidence.

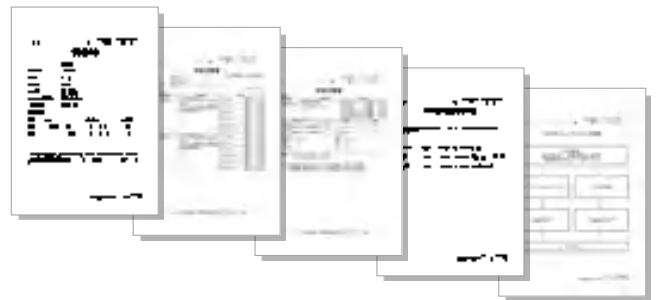

Advanced Technology Delivers Reliable Data



Smart Scan II

PEAK algorithm

The OLS5100 microscope incorporates a PEAK algorithm for 3D data construction. This algorithm provides highly accurate data from low to high magnifications and reduces the data acquisition time.

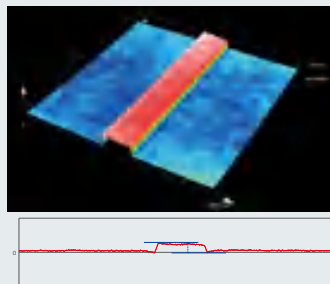

VLSI Standard 80 nm height sample (MPLFLN10XLEXT)

Skip unnecessary scans

When measuring the shape of steps on a sample containing near-vertical planes, such as an electronic component or MEMS, the data acquisition time can be reduced by skipping the unnecessary scanning range in the Z-direction. A 100 μm step can be measured in about 10 seconds without degrading the accuracy (when using a MPLAPON50XLEXT objective).

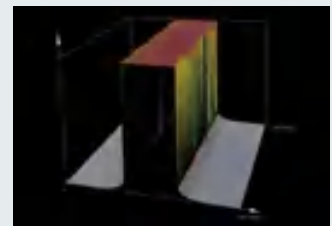

Resist pattern on silicon surface. Courtesy of Nanotechnology Hub in Kyoto University

Accurate shape data

Previously, it was not always possible to capture accurate shape data due to the sample condition and objective lens. The OLS5100 microscope's automatic judgment system adjusts to the requirements of each sample, while the HDR scan acquires two sets of shape information by varying the detection sensitivity to build accurate shape data.

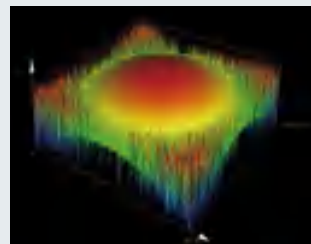

Previous model

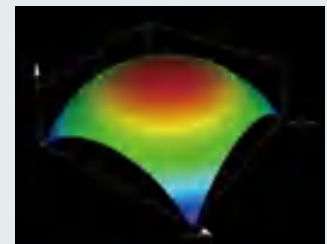

OLS5100 microscope
Ruby ball, radius: 1 mm (MPLAPON20XLEXT)

Positive Traceability

Every component used in the OLS5100 microscope, from the objectives to the laser head, is manufactured in a rigorous production system to maintain high quality. Measurement results are based on a traceability system linked to industrial standards. When the microscope is delivered, qualified engineers make final adjustments and calibrate the system to optimize the microscope for your applications.

Accuracy and repeatability guaranteed*

The performance of a measuring tool is typically expressed using accuracy, which indicates how close a measurement value is to its true value, and repeatability, which indicates the degree of variation in repeated measurement values. Olympus guarantees the accuracy and repeatability of the microscope based on a traceable system so that you can be confident in your measurement results.

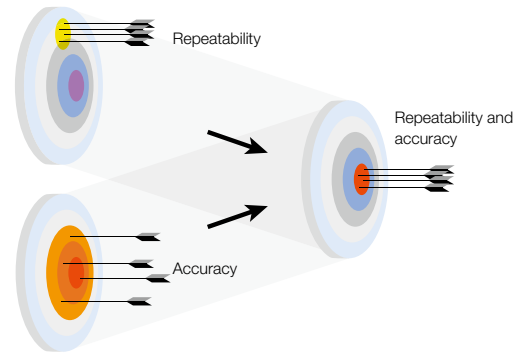

Surface metrology beyond the field of view

The OLS5100 microscope incorporates a length measuring module in the motorized stage, and Olympus guarantees the accuracy of the stitched image data. While previous laser microscopes stitched data based on pattern matching, the OLS5100 microscope adds the position information from the length measuring module to the pattern matching to provide highly reliable stitched data with guaranteed accuracy.

*Only for OLS5100-SAF/EAF



Length measurement module

Accuracy management function

When recording measurement results as evidence, managing the equipment's status is important. The OLS5100 microscope provides an inspection function to check the equipment's status before each measurement as well as a calibration sample (optional) with a calibration certificate. The calibration sample makes it possible to complete the inspection work with a single click and insert the calibration results as a record in the report.



X-Y calibration standard
OLS50-CS-XY



Z calibration standard
OLS50-CS-Z

Vibration Resistance

The OLS5100 microscope's hybrid dampening mechanism uses coil springs and rubber to stabilize the operating environment.

*Only for OLS5100-SMF/SAF



Hybrid vibration dampening mechanism

Global Service Network

Olympus delivers global technical support from service locations around the world (Japan, the United States, Germany, China, South Korea, Singapore, Taiwan, India, and Australia). Each service location has engineers with technical licenses for laser microscopy as well as a proven calibration system to help ensure reliable use after installation.



User-Friendly High-Resolution/High-Magnification Observation



Keep track of your sample's position **Real-time macro mapping**

When the stage moves, the system creates a panoramic macro map that stitches each image together in real time to help keep you from getting lost in the sample. The macro map can also be used in a report to link the magnified images of a sample with their overall locations.

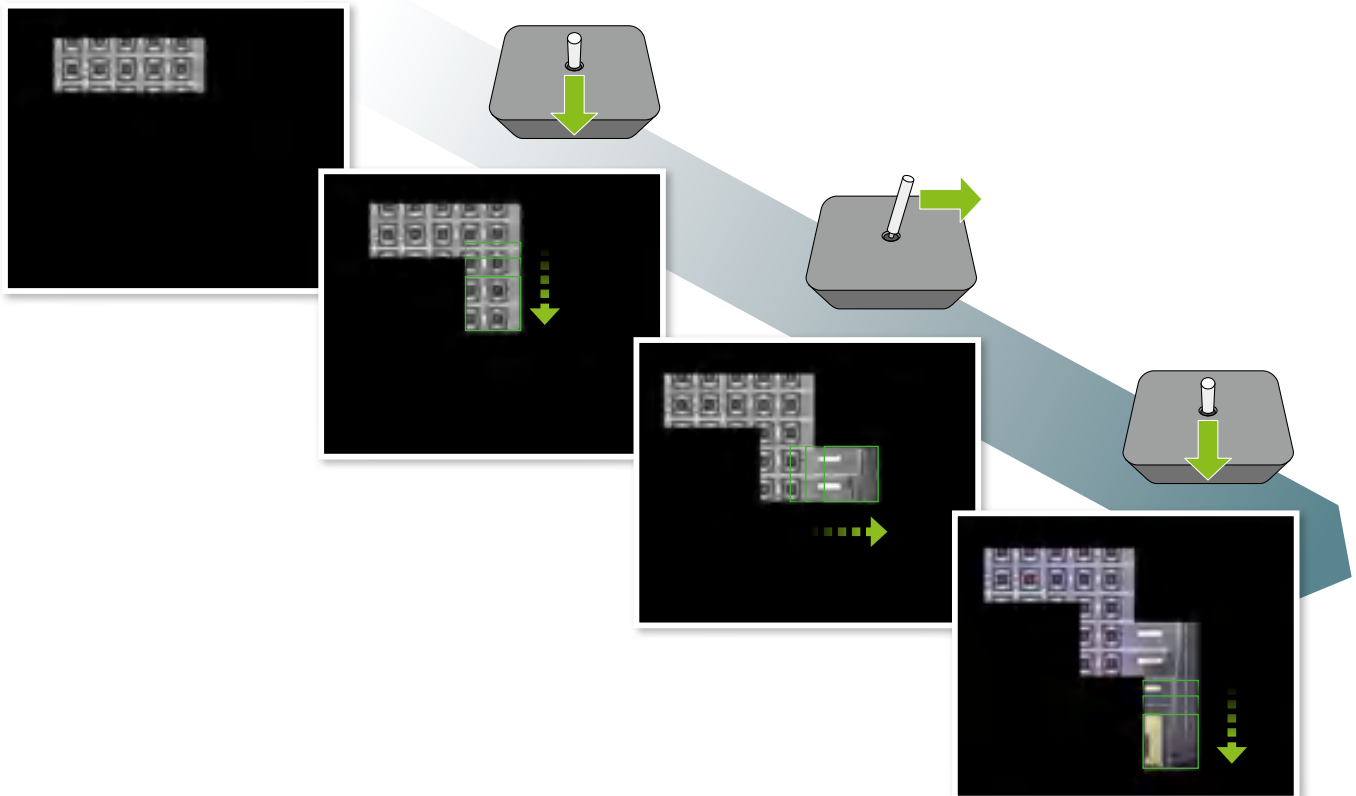

Solving focusing problems

Continuous auto focus

The microscope's continuous autofocus keeps your images in focus when moving the stage or changing objectives, minimizing the need for manual adjustments. Permanent focus tracking enables you to perform observations quickly and easily.

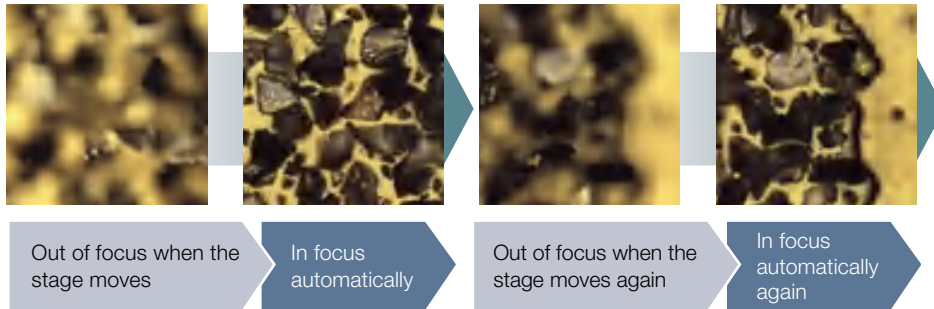

View your sample at the nanometer scale

Dual DIC for nano-scale, real-time observation

Detect minute damage in your sample with real-time, nanometer-scale observation. Differential interference contrast (DIC) observation enables you to visualize nanometer-scale surface contours that are normally beyond the resolving power of a laser microscope. With DIC laser mode, the OLS5100 microscope can obtain live images comparable to those of an electron microscope, even when using a 5x or 10x low-power objective.

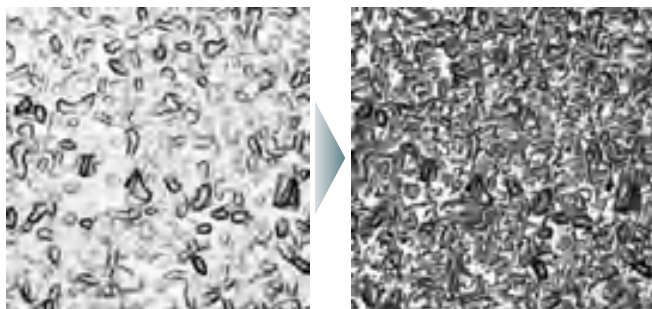

Laser observation
Laser DIC observation
Back surface of wafer



Color observation
Color DIC observation
Hard disk landing zone

See fine shapes

Color HDR observation

The color high dynamic range (HDR) function enables you to observe fine shapes on samples with low contrast or halation. HDR captures multiple images at different exposures and combines them.



Color Image with HDR off
(20X objective, 1x zoom)
Color Image with HDR on
(20X objective, 1x zoom)
Super-density fabric

View color and laser images together

Dual observation

Simultaneously observe a laser image and high-resolution color image to evaluate differences in color or to assess corrosion on metallic surfaces. This feature is also helpful for focusing on very low-contrast samples, such as a mirror surface or film.

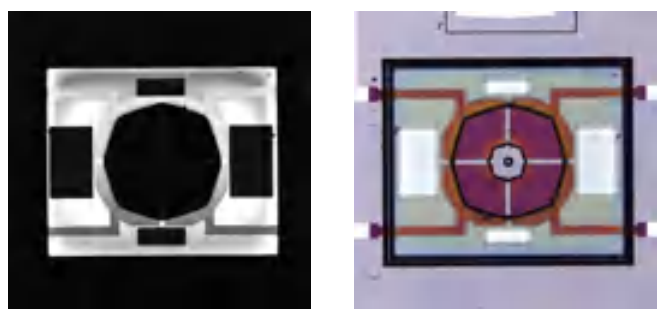

Laser observation image
Real color observation image

Extensive Data Acquisition Tools



Make a wide range of measurements Multiple data acquisition modes

A wide selection of imaging modes are available, including 1-area mode to simultaneously acquire a color image, laser image, and 3D shape data in a single field, and 1-line mode to acquire the shape of a single line in the center of the field. Film thickness mode is also available, enabling you to measure the thickness of a thin film.

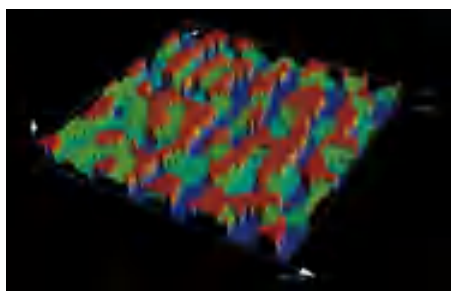

1-area (color image, laser image, 3D shape)

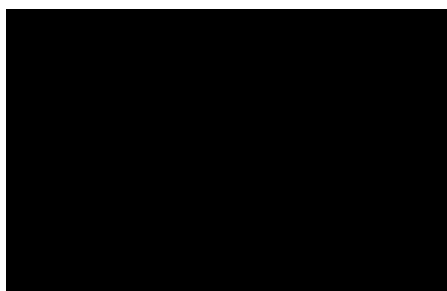

1-line (shape)

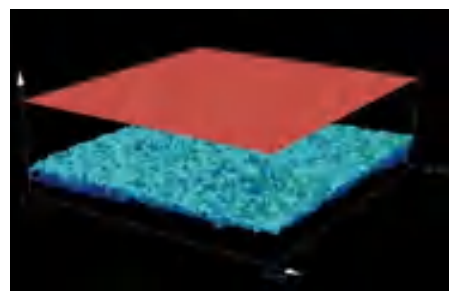

Film thickness (multi-layer mode, fault mode)

High-resolution measurement across a wide field Stitching mode

Accurate data can be obtained from a wide field of up to 36 million pixels by stitching data in a planar direction. The target area can be easily specified on a macro map. The specified stitching area can be saved and recalled later.

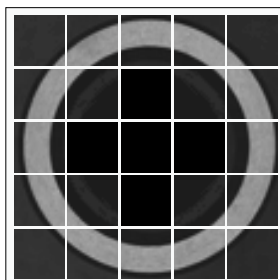

Individual 2D images before stitching



2D image after stitching

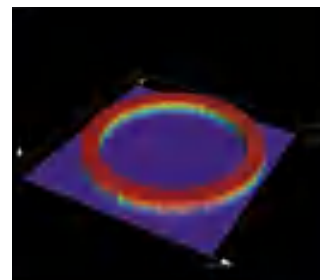

2D image after stitching
Hard disk spindle hub
(MPLAPON20XLEXT / 5 x 5 stitched)

Analyze the shape of the top surface of a transparent film Top surface detection filter

When transparent films are layered on the sample's surface, the OLS5100 microscope can detect the interface with the highest reflected light intensity. The top surface detection filter uses polarization characteristics to detect the top surface's shape.

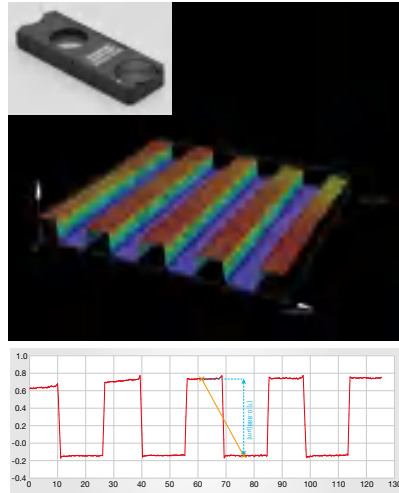

Resist pattern on silicon substrate (MPLAPON100XLEXT)
Courtesy of Nanotechnology Hub in Kyoto University

High-speed data acquisition Band scan

In 3D or film thickness mode for limited target areas, the band scan changes the data size in the Y-direction to acquire data only in the necessary areas, increasing the acquisition speed.

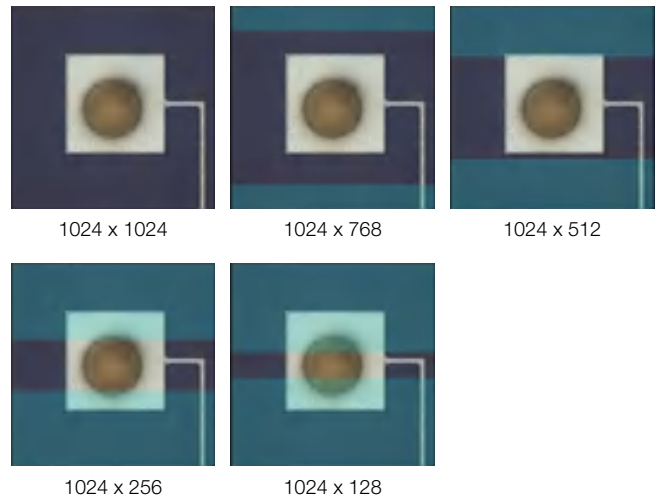

Detailed images of damage and surface irregularities Ultra-high-definition mode

The ultra-high-definition mode is useful when the optical resolution is larger than the size of a single pixel. It makes it possible to accurately capture fine shapes without switching the lens or using zoom magnification.

Standard mode (1024 pixels)

Luminance

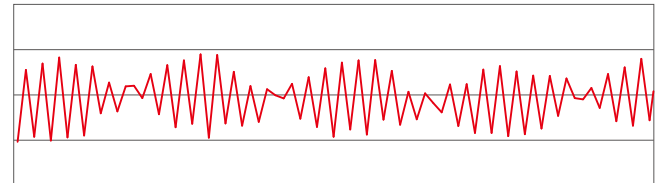

X direction

Ultra-high-definition mode (4096 pixels)

Luminance

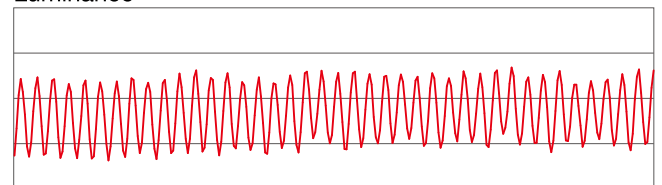

X direction

0.24 μm line & space sample (100x)

Features for Consistent Results

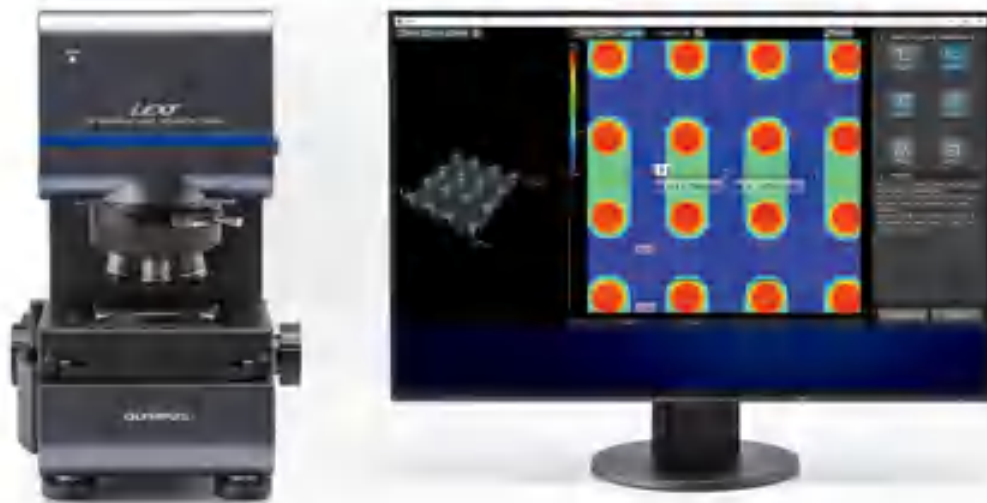

Make measurements in a specified area Simple analysis

The simple analysis function measures the step, line width, surface roughness, and volume only in the specified measurement areas. Typical causes of measurement variance, such as the edge position and the threshold of the reference planes in volume analysis, are automatically detected so that the measurement results remain stable no matter the operator's skill level.

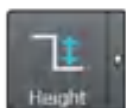
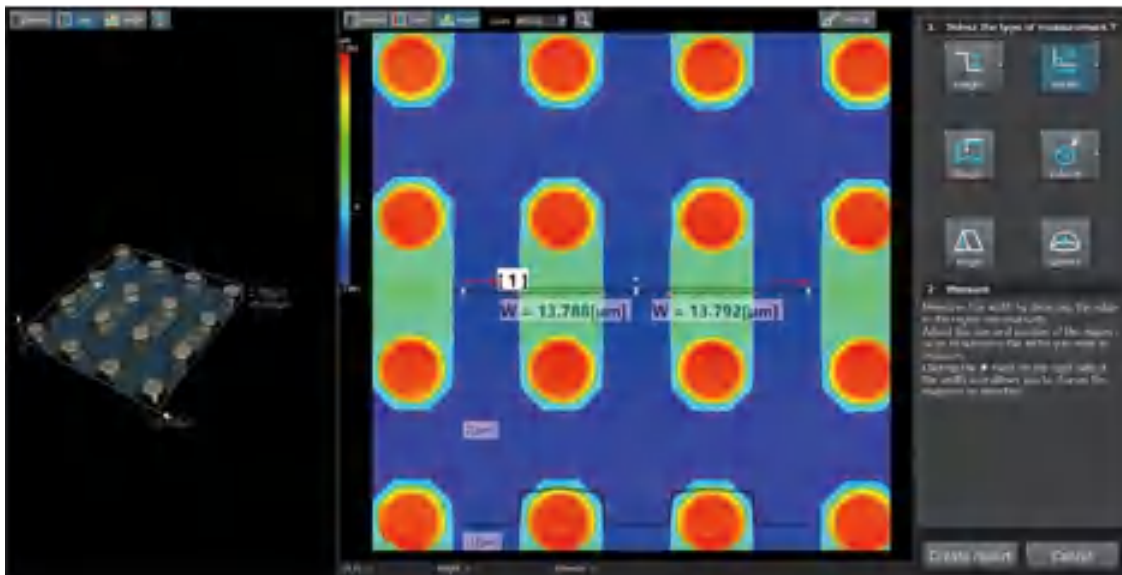

Measure the step height difference and the distance between two specified regions



Measure the difference in angle between two specified regions



Measure the volume in the specified region

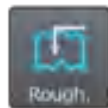

Measure the surface roughness in the specified region

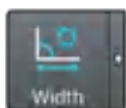

Measure the width by automatically detecting edges in the specified region

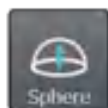

Measure R and the height from the reference plane based on the automatic recognition of a circular shape in the specified region

One-click automatic correction Auto correction

Some laser microscopes require preprocessing of the acquired data, such as noise elimination and inclination correction, slowing down the scan time and making more work. With one click, the OLS5100 microscope automatically eliminates measurement noise without removing accurate data and detects the main horizontal plane (reference plane) at the height zero position. There are no complicated settings, so the user's skill and experience minimally impact the results.

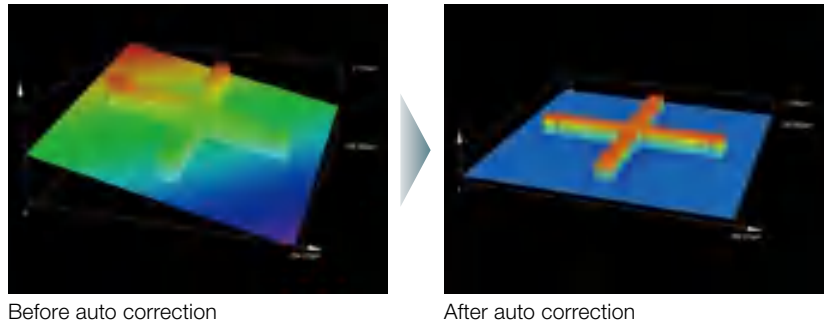

Before auto correction

After auto correction

One-click profile measurement Profile measurement

The profile measurement function displays the surface profile by arbitrarily drawing a measurement line on the position to be measured on an image. It also measures the step between any two arbitrary points, width, cross-sectional area, and radius. Unlike contact-based measuring tools, setting the measured positions is easy. The measurement lines and points can be checked on the image, so even a very small site can be measured accurately.

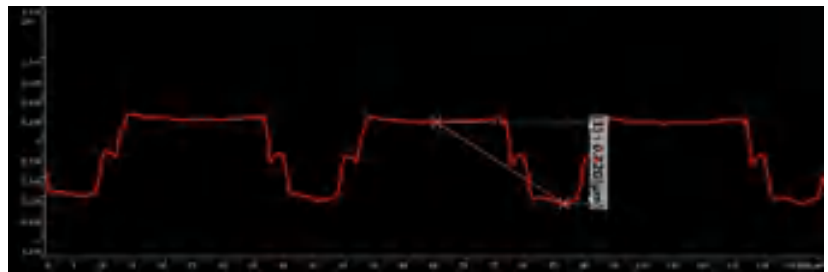

Surface profile

Automatically extract feature points Profile assist tool

The desired measurement line can be designated by specifying the maximum/minimum points on the specified site, the intersection of two lines, center of a cylinder, or center of a sphere. When a site is specified in the acquired data, feature points are automatically extracted according to specified conditions, reducing operator-related variations.

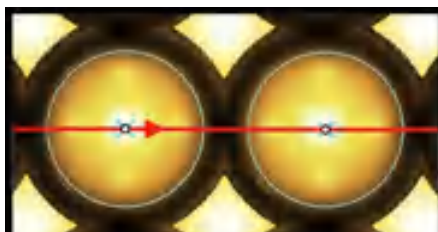

Specification of a measurement line passing through the center of a sphere

Automatically extract feature points Measurement assist tool

The point to be measured can be correctly specified using the highest, lowest, middle, and/or mean points. When a site is specified in the acquired data, the feature points are automatically extracted according to specified conditions.

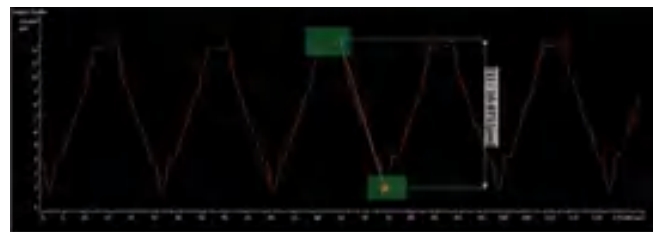

Measurement of the step between the highest and lowest points in a surface profile

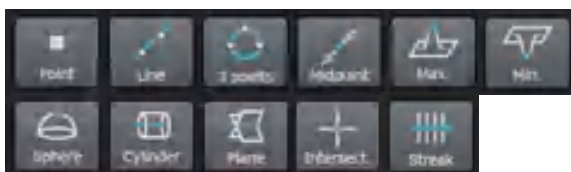

Comprehensive Analysis and Reporting

ISO4287 compliant

Line roughness measurement

A contact surface roughness gauge is incapable of precisely measuring the target position on a tube or wire because of the difficulty of placing the stylus on a very small site. The OLS5100 microscope enables operators to specify the measurement line after data acquisition from the surface so that the line roughness of a small target can be measured easily.

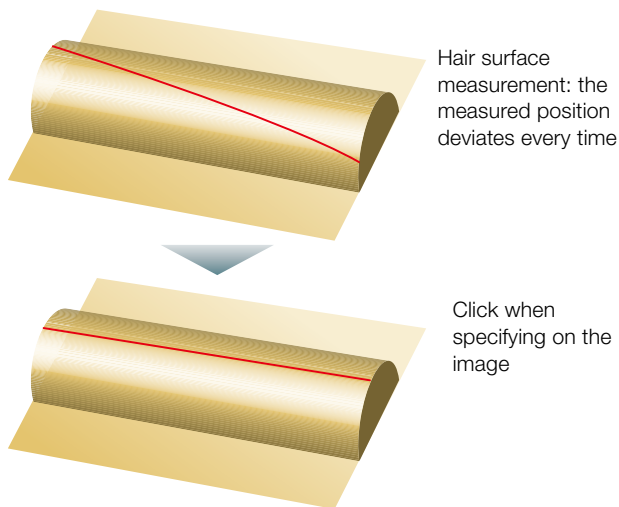

ISO25178 compliant

Areal roughness measurement

The OLS5100 microscope scans the sample surface with a 0.4 μm diameter laser beam, enabling it to easily measure the surface roughness of samples that cannot be measured with contact surface roughness gauges. The ability to simultaneously acquire the color image, laser image, and 3D shape data of a surface that can't be measured with a contact surface roughness gauge expands the scope of analysis.

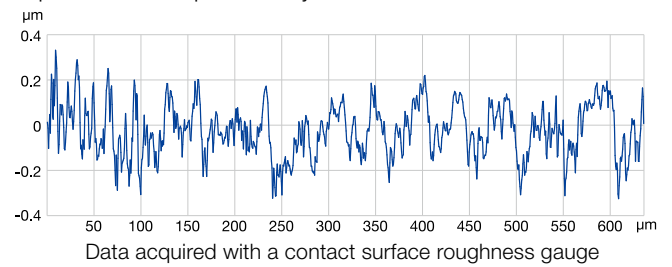

Color image

Laser image

3D shape data

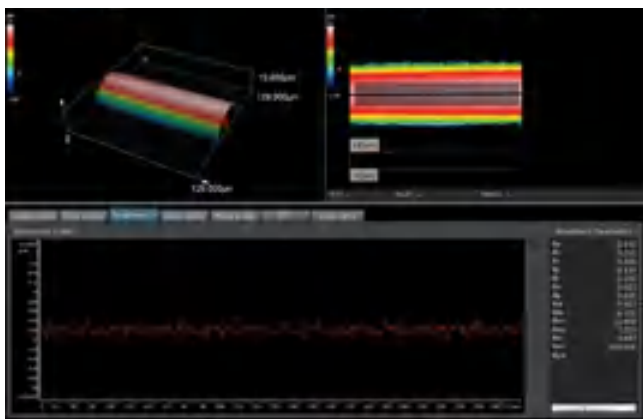

Line roughness measurement of an ultra-thin pipe

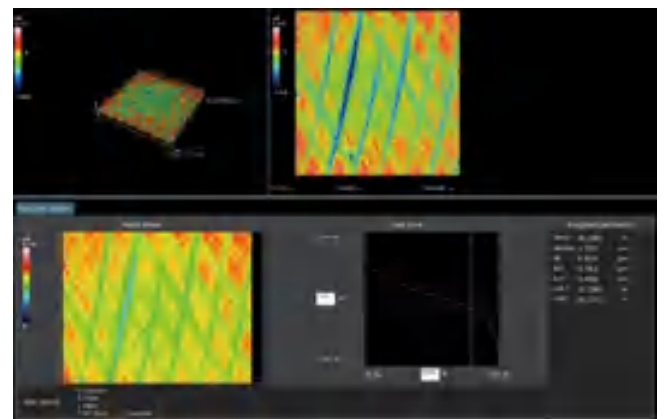

Surface roughness measurement of a polished metallic surface



Since 2011, Olympus has been a member of the Technical Committee of the International Organization for Standardization (ISO/TC213), which was set up to promote the standardization of 3D surface measurement, as well as to promote the use of 3D surface measurement in industry. As part of its ongoing efforts to contribute to the advancement of manufacturing in Japan, Olympus will continue to offer 3D surface measurement solutions that comply with international standards.

Specify points precisely

In-plane measurement

Various measurements—including the distance between two points, the angle formed by two lines, and the area of a specified site—can be executed on an image. An auto edge detection function is also available, enabling precise position specification regardless of the operator's skill.

Compare heights with a reference plane

Step height measurement

Specifying the height reference site and the measurement site—which will be used as a comparison target—in the acquired data enables you to quantify the maximum, minimum, and average step differences between the reference and measured sites. The specified sites can be saved and loaded later, making this function ideal for repeated measurements.

Confirm differences in data visually and quantitatively
Difference measurement

Differences—including go/no-go judgments, shape (height) differences before/after wear, surface areas, and volumes—can be confirmed visually and quantitatively. With just a single click, you can align the position between XYZθ data and angle adjustment data in the horizontal direction, making it easy to analyze the differences in surface shapes.

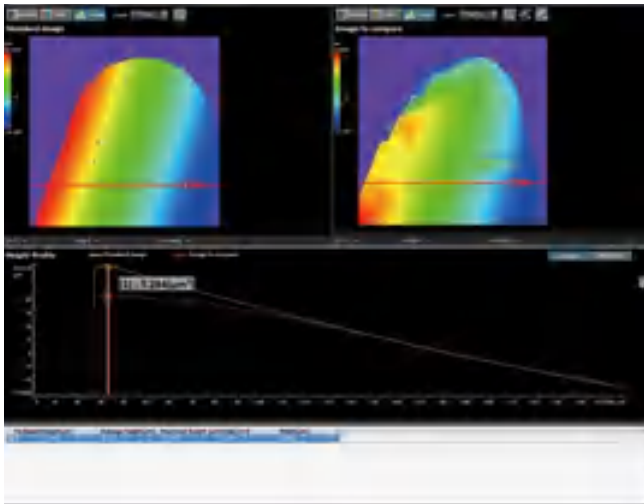

Wear measurement of tool tip (MPLAPON50XLEXT)

Automatically detect multiple surface irregularities
Area/volume measurement

The area and volume of sites with surface irregularities can be measured by setting the reference height plane in the acquired image. The reference plane can also be automatically detected based on the sample's shape. When multiple sites with surface irregularities are detected, the volume, area, surface area, and the height from the reference plane of each of site can be measured.

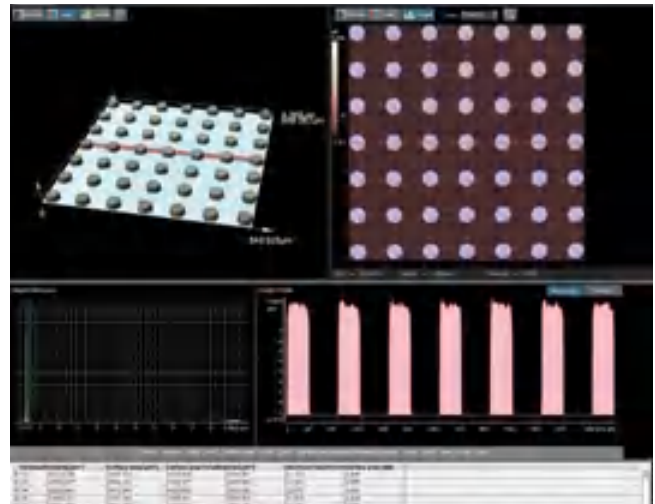

Bump (MPLAPON20XLEXT)

Step and area measurements
Histogram analysis

The acquired height data and the distribution of color or laser intensity are represented as histograms that can be used for step and area measurements. The output of statistical quantities, such as the mode, half-value width, and 3σ , as well as auto histogram peak detection, are available.

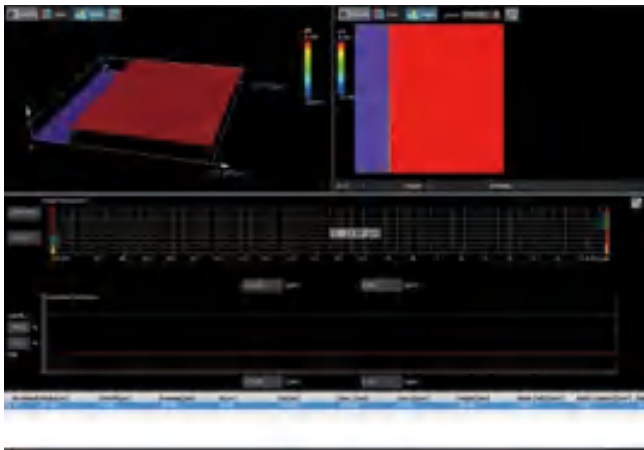

Photoresist (MPLAPON100XLEXT)

Automatically measure repetitive shapes
Sphere/cylinder/surface angle analysis

If your sample has repetitive shapes—like a microlens array or light guide panel—its radius, residual error, and surface angle can be measured. By specifying a feature as the site of interest, the microscope can automatically acquire data on all identical features.

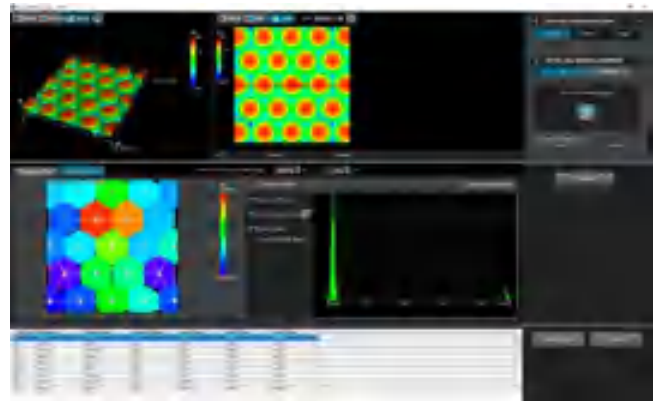

Measurement example of sphere analysis mode
 Micro lens array (MPLAPON100XLEXT),
 courtesy of KOSHIBU PRECISION CO.,LTD.

Comprehensive Analysis and Reporting Functions

Measure the width and height automatically Auto edge measurement

You can easily measure the width and height of a regular pattern on a semiconductor chip based on the specified detection conditions. You can apply various settings to the color image, laser image, and 3D shape data according to the features of the sample. This is especially useful for repeat sample measurements.

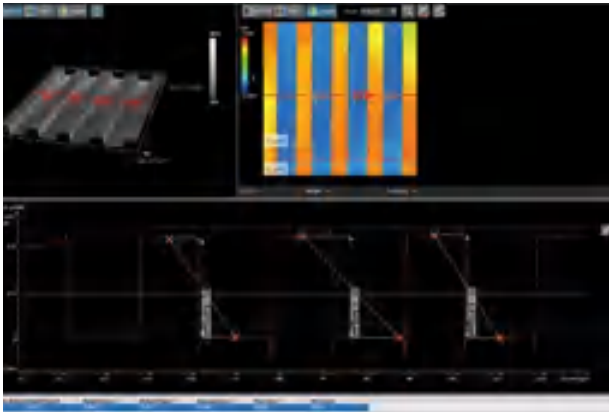

Resist pattern on silicon substrate (MPLAPON100XLEXT)
Courtesy of Nanotechnology Hub in Kyoto University

Particle diameter/center of gravity measurements Automatic particle analysis

The system can detect particles automatically. The diameter, center of gravity, Feret's diameter, and the degree of roundness can be measured, and the results displayed in a histogram.

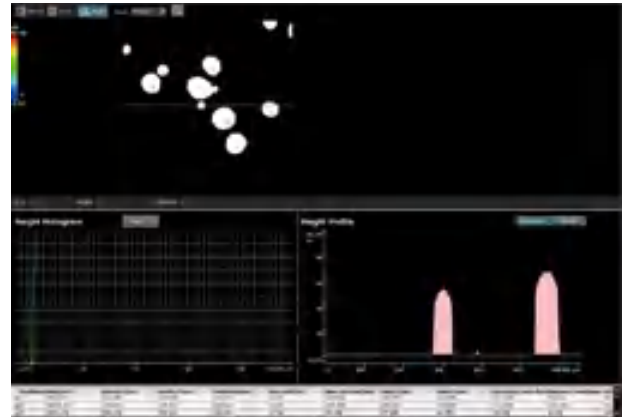

Ceramic particle (MPLAPON20XLEXT)

Measure the thickness of transparent layers Film thickness measurement

The film thickness and interface height of a transparent body can be measured. The multi-layer mode is useful to analyze the 3D extension, structure, and position relationship of a transparent film. The fault mode turns the light detection intensity into an image and is useful when analyzing interfaces with very low reflection intensity.

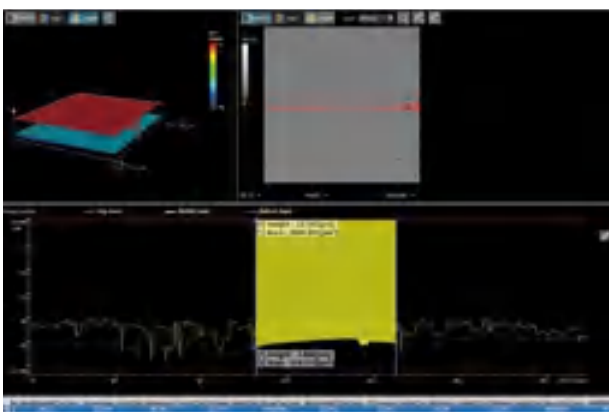

Multi-layer mode

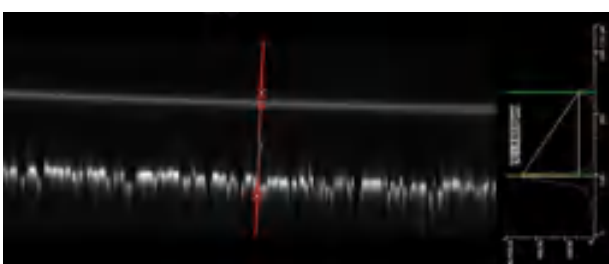

Fault mode

Comparative data analysis Multi-data analysis

You can analyze multiple acquired datasets side by side with their display scales and 3D display angles integrated; image correction and analysis can be performed simultaneously. This function is useful for analyzing the shape of multiple samples with different processing conditions or for defect analysis. Various images, profiles, and numerical results can be exported to Excel, making it easier to quickly arrange and evaluate your data.

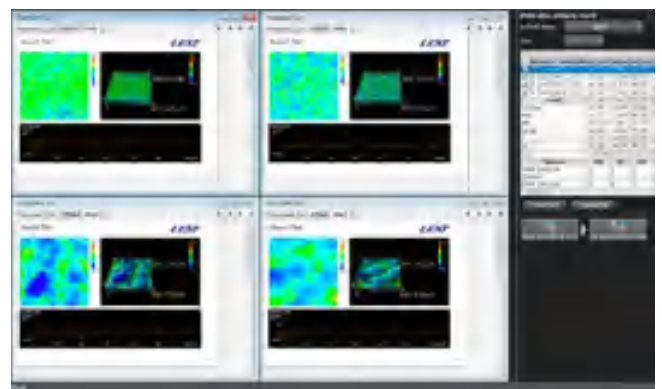

Specialized analysis Integrates with OLYMPUS Stream™ software

Data captured with an OLS5100 microscope can be easily displayed and analyzed using optional OLYMPUS Stream image analysis software for specialized applications.

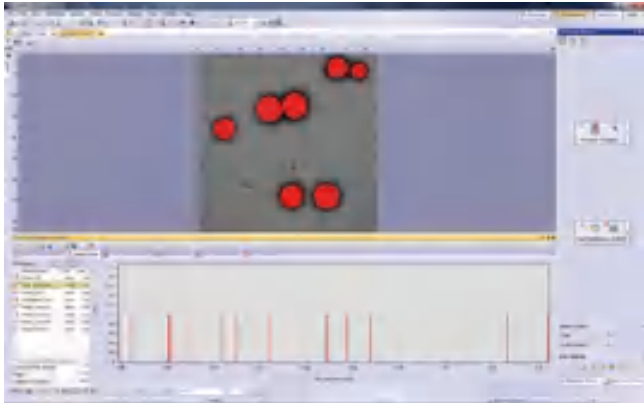

Easy data export for reports Report outputs

It's simple to export your analysis results to a customizable report. In addition to the editable LEXT™ file format, data can also be exported to Excel, PDF, or RTF.

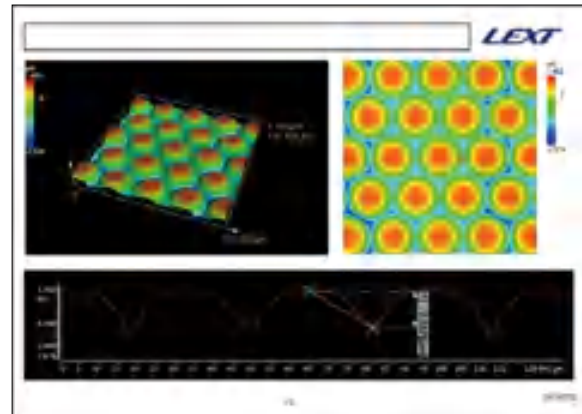

Easily undo/redo operations Image processing history

The image processing history of your data is saved by the microscope, enabling you to display it and undo/redo previous operations. This is convenient when confirming the image processing used for other data or when confirming the processing content with other acquired data.

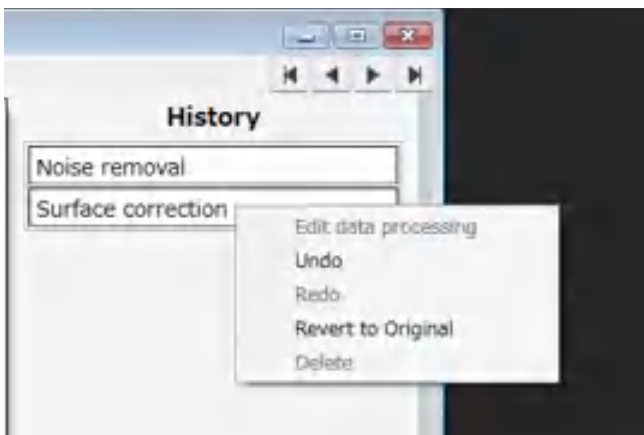

Export data to a CAD program CAD data output

You can output data in STL format (mesh data) for use in a CAD application. Viewing the data in commercially available CAD software can help you visualize and quantify the differences between the design data and STL data.

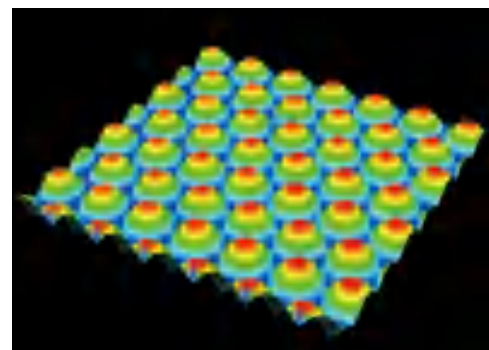

Acquired data
(height data)



STL format
data

Analysis Software for Multiple PCs

The microscope's analysis software can be installed on multiple PCs. If you have your data on a server in your office, you can access it remotely and continue your work from home.

Automated Functions Ease Your Workflow

Automate tasks for greater consistency

Analysis template function

All the operations and procedures included in a report can be saved as a template. Using the template when repeating the same measurements helps ensure consistency between analysis reports and between users.

Conduct the inspection and take measurements

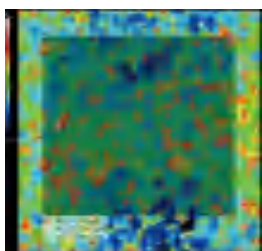

Output the report and save the template

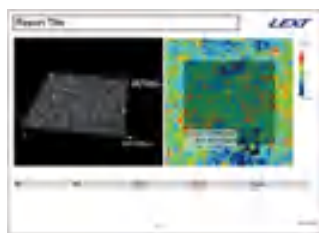

During the next acquisition, open the saved template

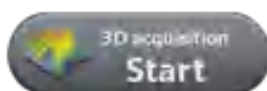

Instantly output a report based on the template

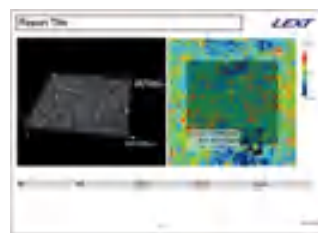

Automatic position correction

Auto position alignment

By pre-registering the reference sample's feature site, the XYZθ of the acquired data can be automatically adjusted. This is helpful when repeatedly inspecting the same sample using the Analysis Template function.

Simpler repetitive testing

Alignment function

When testing a succession of samples with similar shapes, the alignment function sets the motorized stage's coordinate system to match the sample's for more efficient inspection. This function enables you to acquire the same data in the same position for all subsequent samples simply by placing the sample on the stage.

Acquire data from multiple positions simultaneously

Multi-area data acquisition

You can automate routine inspection workflows—from data acquisition to measurement and reporting—using the macro compilation tool. Then, all you need to do is recall and execute an existing macro file to obtain measurement results with a single click.

Automate routine workflows

Macro function

You can automate the entire inspection workflow using the macro production tool. Easily create and edit procedures, and then run the registered macro file to obtain reliable results with one click.

Five language options

Manual available in multiple languages

The software supports Japanese, English, German, Chinese, and Korean. The instruction manual is available in multiple languages for ease of use.

Manage user permissions

User account function

Each user has their own login and can customize their software interface to their preferences. The user ID is recorded with the acquired data and in the report for easy tracking. Admins can assign the operations and functions available to each user to control access to unnecessary functions.

Compatible with a Variety of Samples

Works with tall samples Extension frame

The microscope's extension frame enables you to place samples up to 210 mm (8.3 in.) tall on the stage and obtain measurements with guaranteed accuracy and repeatability.



Reference height is adjustable by removing the extension blocks.

A range of objectives for your application Compatible objectives

Fifteen available objectives, including several dedicated LEXT™ objectives tuned to the microscope's 405 nm laser, enables you to select the configuration that best fits your application.



Guaranteed measurement performance Dedicated LEXT objectives

Available LEXT long working distance and 10x objectives enhance the microscope's measurement performance and offer guaranteed accuracy and repeatability.

Standard roughness sample 529 by Rubert & Co., Ltd. (Pt = 0.3 μm)

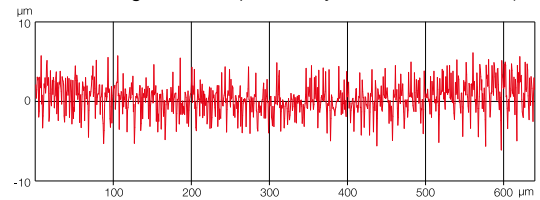

General-purpose lens (20x)

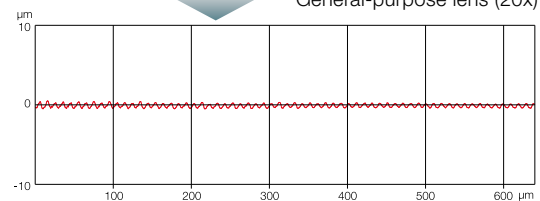

LEXT-dedicated lens (20x)

Advantages of a Laser Microscope Over Other Measuring Tools

Optical microscope, digital microscope

Issue 1 Unable to measure small shapes

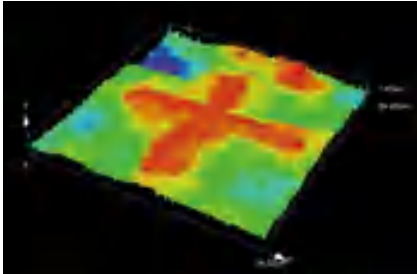

Precision 3D measurement

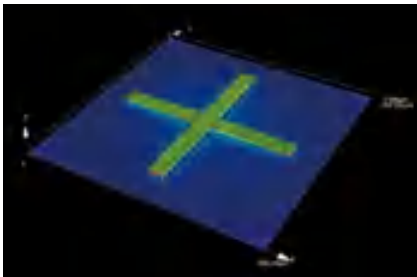

Issue 2 Poor lateral resolution



0.12 μm lateral resolution

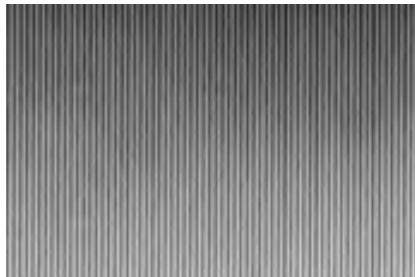

Issue 3 Non-traceable measurement results

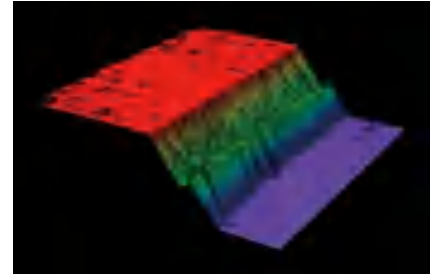

Traceable measurement results



Stylus surface roughness tester

Issue 1 Can damage the sample's surface

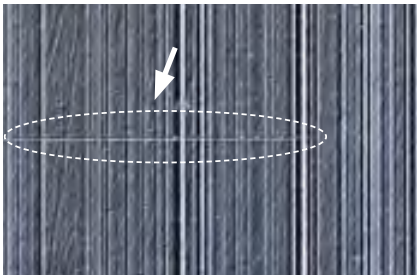

Non-contact measurement doesn't damage the sample



Issue 2 Information from only one line

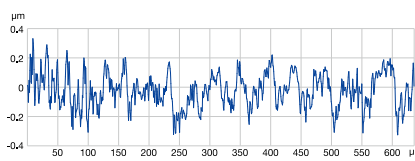

Data with stylus surface roughness meter

Acquire information from an entire plane

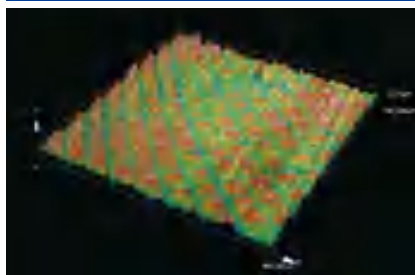

Issue 3 Difficult to place the stylus on a target position

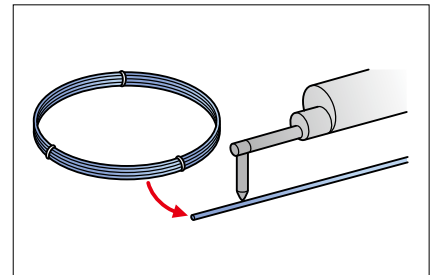

Pinpoint measurement

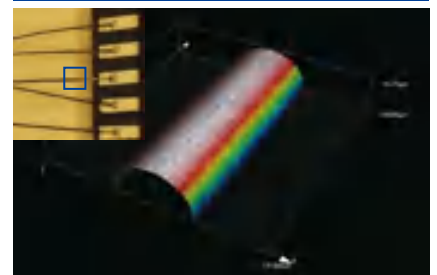

White light interferometer

Issue 1 Has difficulty capturing rough surface shapes

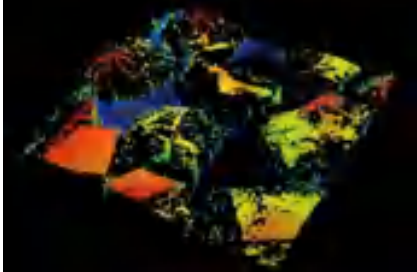

Accurate rough surface measurement by capturing small slopes

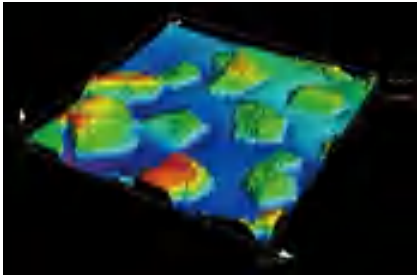

Issue 2 Poor lateral resolution makes positioning difficult



0.12 μm lateral resolution

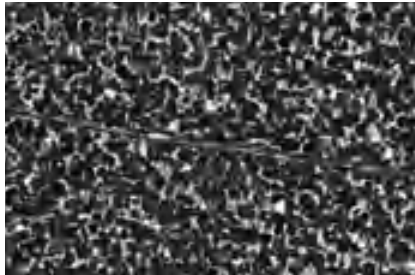

Issue 3 Inconvenient inclination adjustment



Just place your sample on the stage to start measurement



Scanning electron microscope (SEM)

Issue 1 No color information

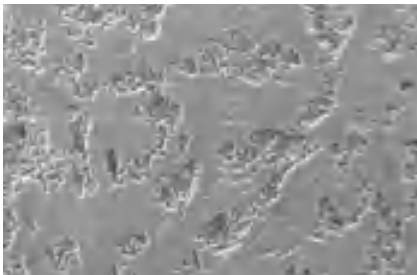

High-definition color observation



Issue 2 Samples must be destroyed and prepared in advance

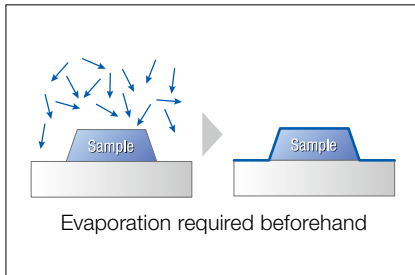

Nondestructive, and no sample preparation required



Issue 3 3D shape measurement is not possible



Precise 3D measurement



Automotive/Metal Processing

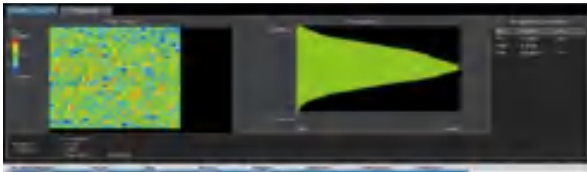
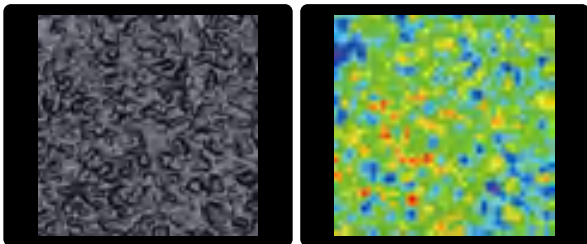
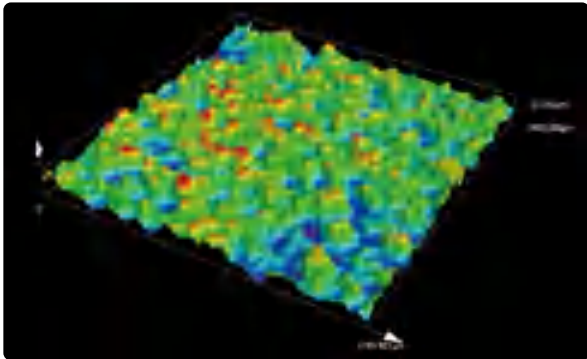

Inner texture / Texture evaluation (Area roughness measurement)
(MPLAPON20XLEXT / 3 × 3 stitched)

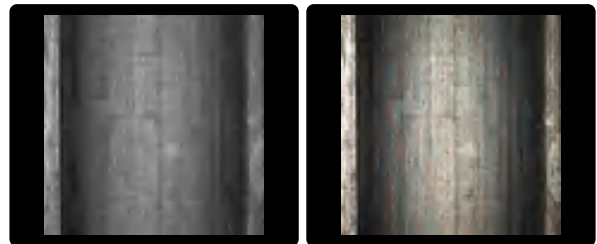
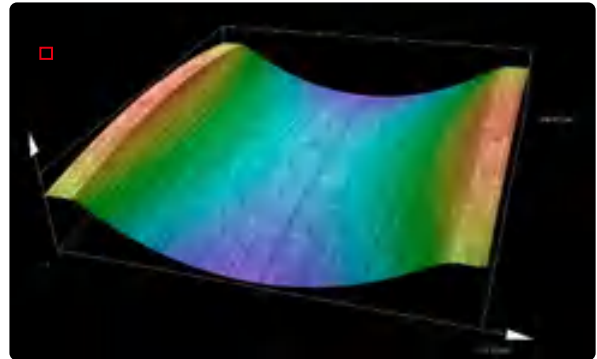

Miniature Bearing / area roughness (MPLAPON20XLEXT)

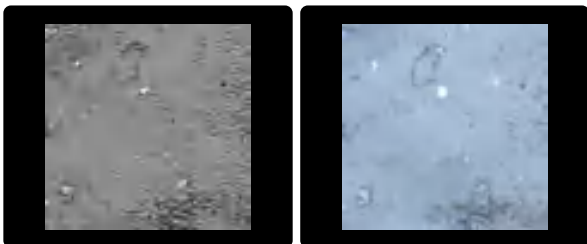
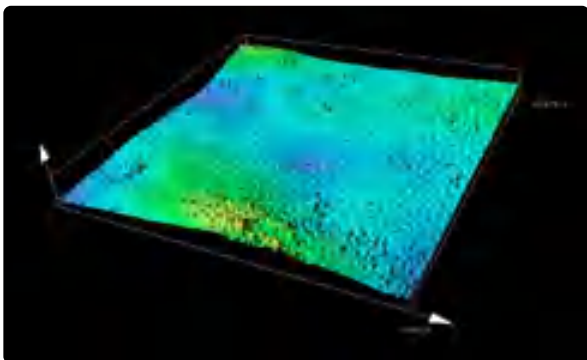

Gear Teeth for Eco-Friendly Cars / area roughness
(MPLAPON100x)

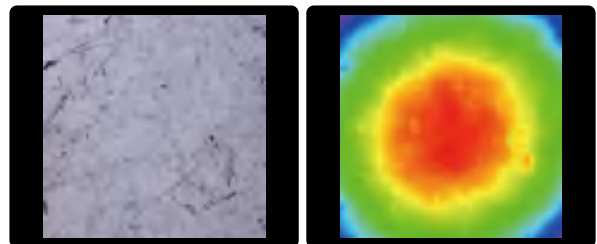
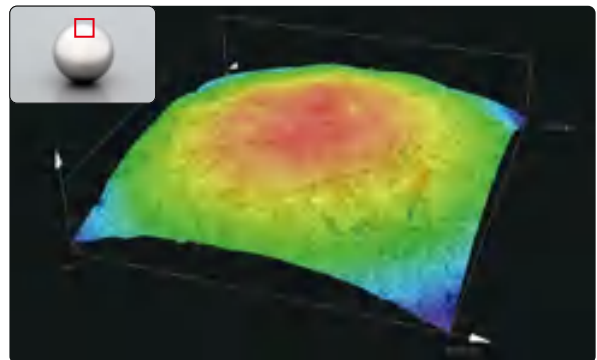

Bearing ball / Scratch depth evaluation (Profile measurement)
(MPLAPO50XLEXT)

Materials

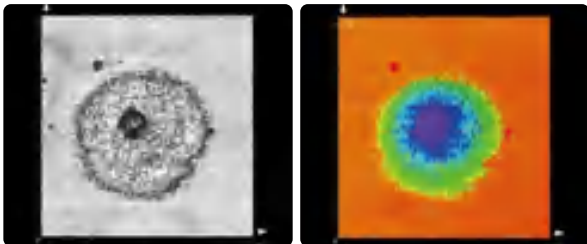
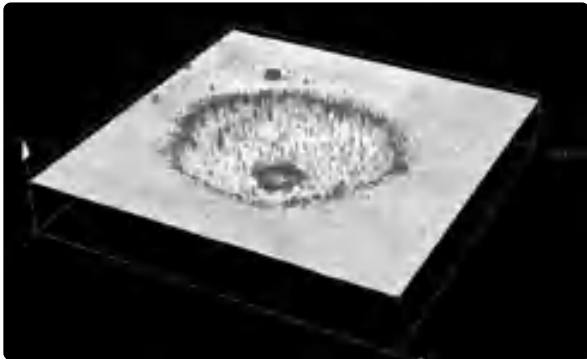

Corrosion on stainless steel / Height measurement
(MPLAPON20XLEXT / 3 x 3 stitched)

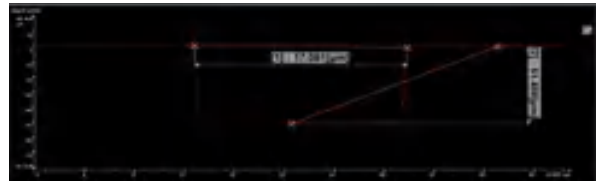
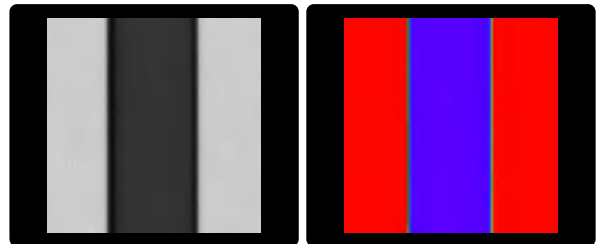
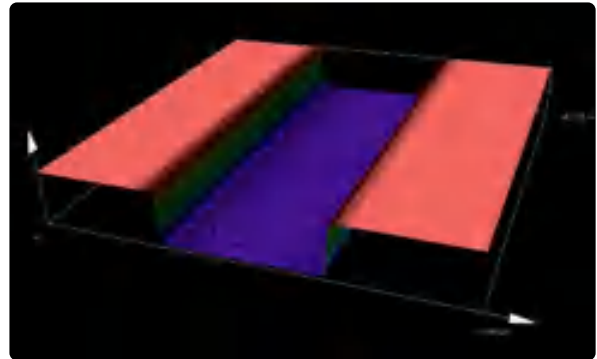

Microchannels/ Profile measurement
(MPLAPON100XLEXT)

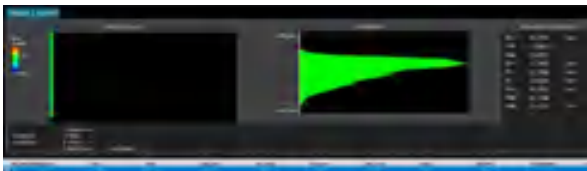
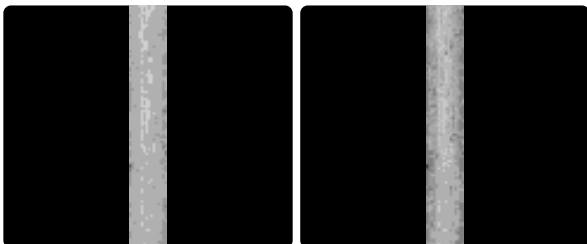

Injection needle
(MPLAPON50XLEXT / 1x7 stitched)

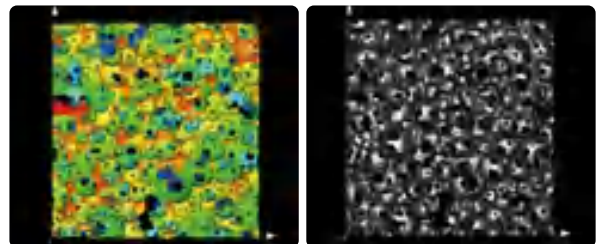
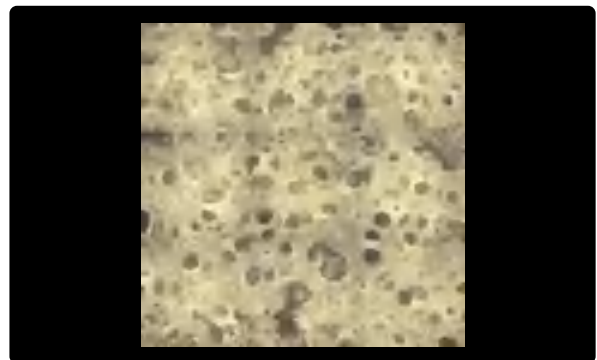

Sponge / Profile measurement
(MPLAPON20XLEXT / 3 x 3 stitched)

Electronic Components

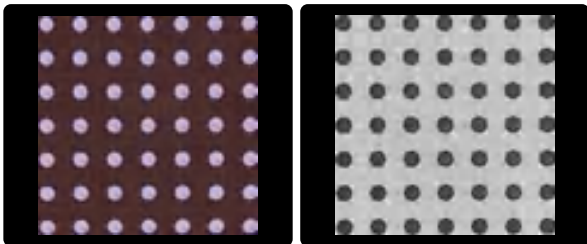
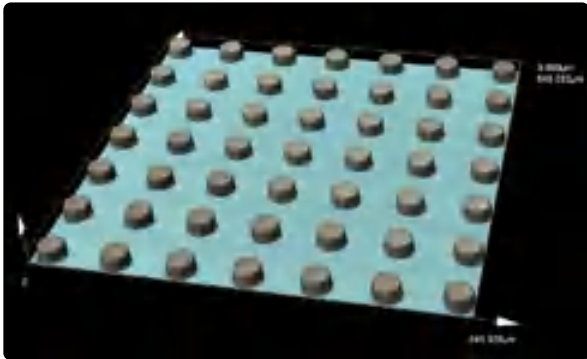

Metal bump / Joint uniformity (Height evaluation)
(MPLAPON20XLEXT)

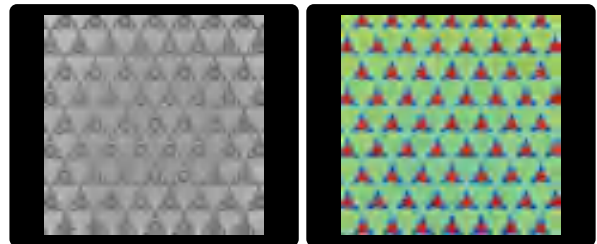
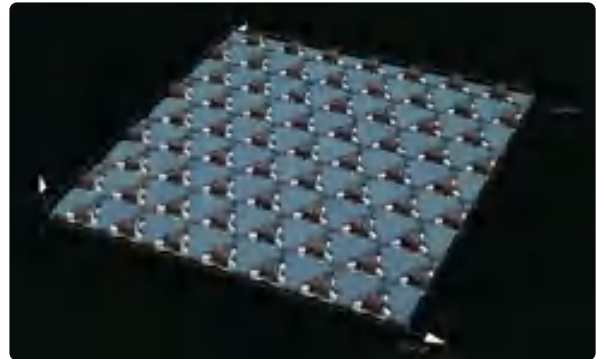

MEMS ultrasonic transducer / Shape evaluation (Profile measurement)
(MPLAPON50XLEXT)

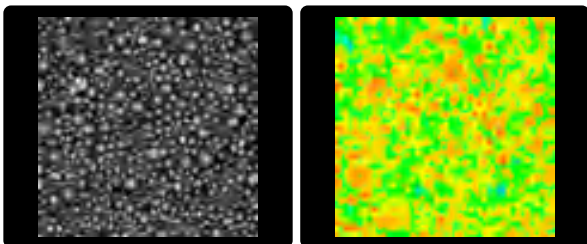
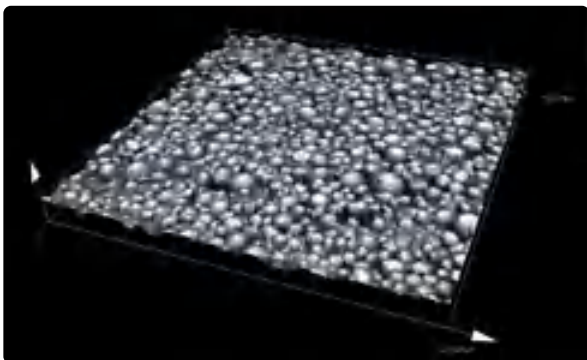

Lithium-Ion Battery Electrodes / area roughness
(MPLAPON50XLEXT)

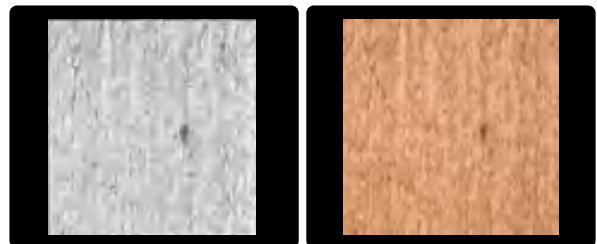
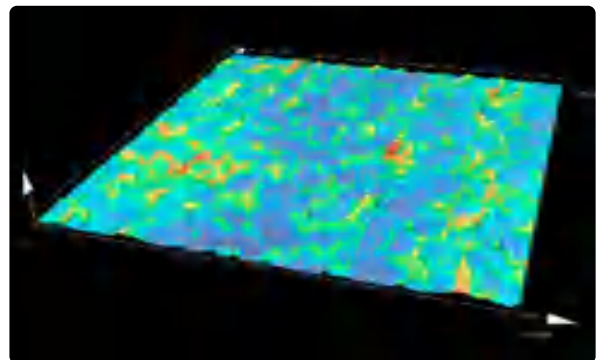

PCB Copper foil / area roughness (MPLAPON50XLEXT)

Others

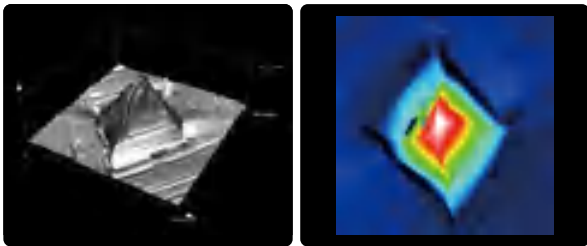
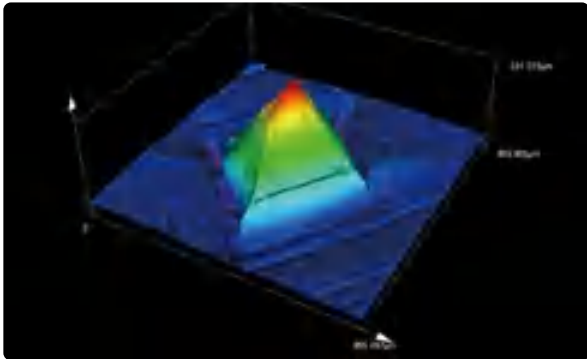

Micro needle / Shape evaluation (Profile measurement)
(MPLAPON50XLEXT / 6 × 6 stitched)

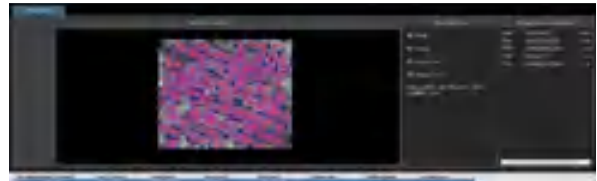
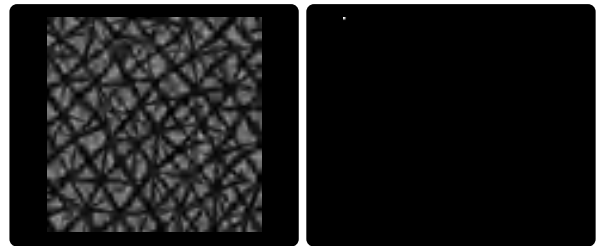
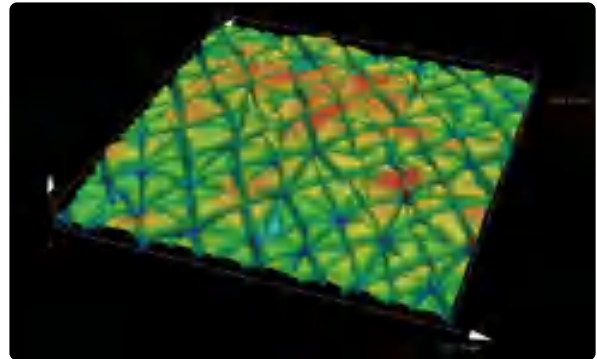

Skin (replica) / Area roughness measurement
(MPLAPON20XLEXT / 5 × 5 stitched)
Courtesy of Functional Design Laboratory, Faculty of Fashion
Science, Bunka Gakuen University

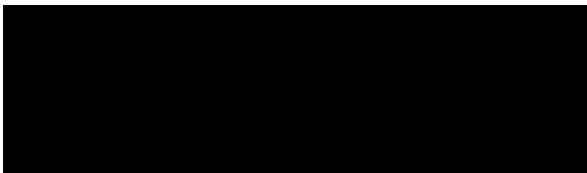
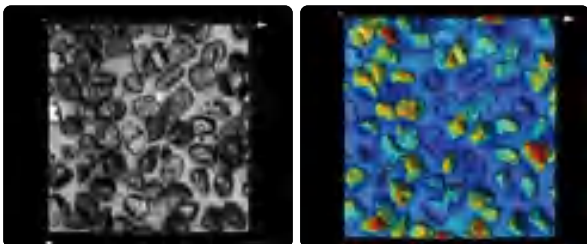

Grind stone / Profile measurement
(MPLAPON20XLEXT)

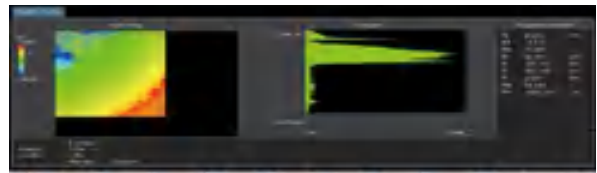
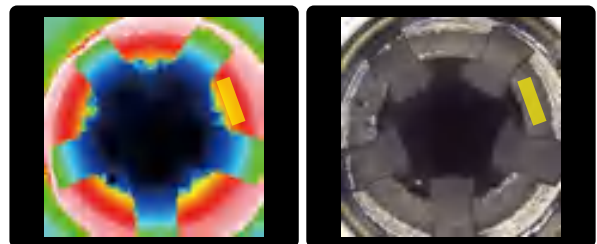
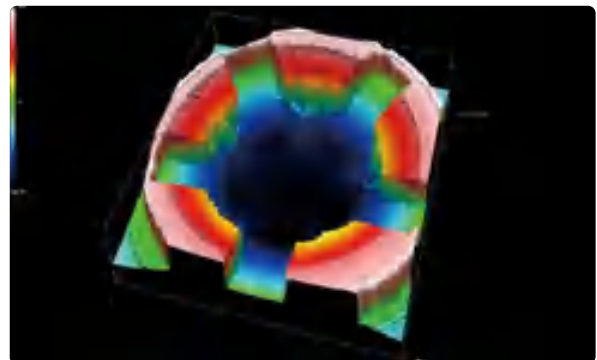

Acceptance seat of ballpoint pen / Area roughness
measurement (LMPLFLN20XLEXT)

Product Lineup



OLS5100-SAF Setup Example

3D Measuring Laser Microscope OLS5100-SAF

- 100 mm motorized stage
- Max. height of sample:
100 mm (3.9 in.)

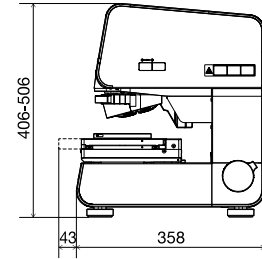
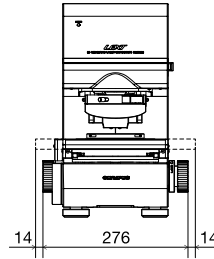

3D Measuring Laser Microscope OLS5100-EAF

- 100 mm motorized stage
- Max. height of sample:
210 mm (8.3 in.)

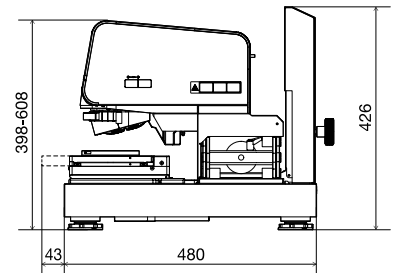
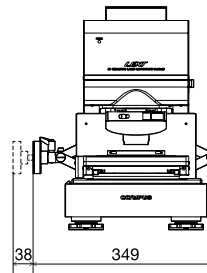

3D Measuring Laser Microscope OLS5100-SMF

- 100 mm manual stage
- Max. height of sample:
40 mm (1.6 in.)

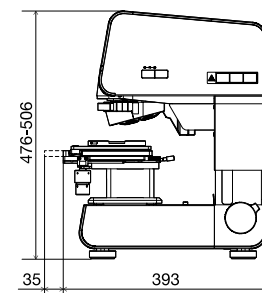
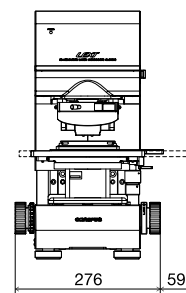

3D Measuring Laser Microscope

OLS5100-LAF

- 300 mm motorized stage
- Max. height of sample: 37 mm (1.5 in.)

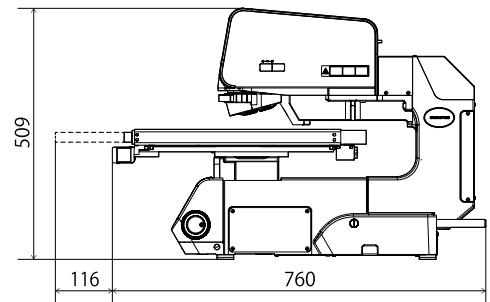
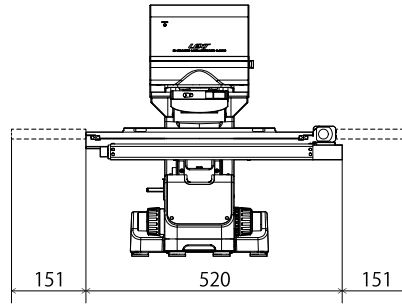

Unit: mm

Control Unit

Unit: mm

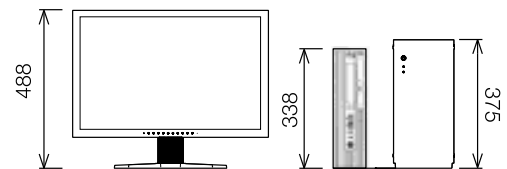
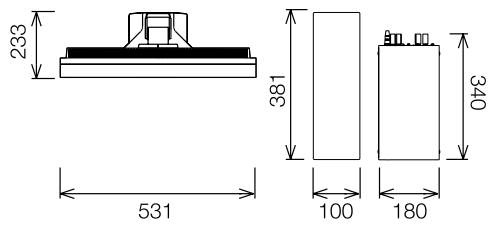

SPECIFICATIONS

MAIN UNIT SPECIFICATIONS

Model	OLS5100-SAF	OLS5100-SMF	OLS5100-LAF	OLS5100-EAF	
Total magnification	54x-17,280x				
Field of view	16 μm-5,120 μm				
Measurement principle	Optical system	Reflection-type confocal laser scanning laser microscope Reflection-type confocal laser scanning laser-DIC microscope Color Color-DIC			
	Light receiving element	Laser: Photomultiplier (2ch) Color: CMOS color camera			
Height measurement	Display resolution	0.5 nm			
	Dynamic range	16 bits			
	Repeatability σ_{n-1} *1 *2 *5	5X : 0.45 μm, 10X : 0.1 μm, 20X : 0.03 μm, 50X : 0.012 μm, 100X : 0.012 μm			
	Accuracy *1 *3 *5	0.15 + L/100 μm (L: Measuring length [μm])			
	Accuracy for stitched image *1 *3 *5	10X : 5.0+L/100 μm, 20X or higher : 1.0+L/100 μm (L: Stitching length [μm])			
Width measurement	Measurement noise (Sq noise) *1 *4 *5	1 nm [Typ]			
	Display resolution	1 nm			
	Repeatability $3\sigma_{n-1}$ *1 *2 *5	5X : 0.4 μm, 10X : 0.2 μm, 20x : 0.05 μm, 50X : 0.04 μm, 100X : 0.02 μm			
	Accuracy *1 *3 *5	Measurement value +/- 1.5%			
Accuracy for stitched image *1 *3 *5	10X : 24+0.5L μm, 20X : 15+0.5L μm, 50X : 9+0.5L μm, 100X : 7+0.5L μm (L: Stitching length [mm])				
Maximum number of measuring points in a single measurement	4096 × 4096 pixels				
Maximum number of measuring points	36 megapixels				
XY stage configuration	Length measurement module	•	NA	NA	•
	Operating range	100 mm × 100 mm (3.9 in. × 3.9 in.) Motorized	100 mm × 100 mm (3.9 in. × 3.9 in.) Manual	300 mm × 300 mm (11.8 in. × 11.8 in.) Motorized	100 mm × 100 mm (3.9 in. × 3.9 in.) Motorized
Maximum sample height	100 mm (3.9 in.)	40 mm (1.6 in.)	37 mm (1.5 in.)	210 mm (8.3 in.)	
Laser light source	Wavelength	405 nm			
	Maximum output	0.95 mW			
	Laser class	Class 2 (IEC60825-1:2007, IEC60825-1:2014)			
Color light source	White LED				
Electrical power	240 W	240 W	278 W	240 W	
Mass	Microscope body	Approx. 31 kg (68.3 lb)	Approx. 32 kg (70.5 lb)	Approx. 50 kg (110.2 lb)	Approx. 43 kg (94.8 lb)
	Control box	Approx. 12 kg (26.5 lb)			

*1 Guaranteed when used in constant temperature and constant-temperature environment (temperature: 20 °C±1 °C, humidity: 50%±10%) specified in ISO554(1976), JIS Z-8703(1983). *2 For 20x or higher, when measured with MPLAPON LEXT series objectives. *3 When measured with dedicated LEXT objective. *4 Typical value when measured with MPLAPON100XLEXT objective, and may differ from the guaranteed value. *5 Guaranteed under Olympus Certificate System.

OBJECTIVE SPECIFICATIONS

Series	Model	Numerical Aperture (NA)	Working Distance (WD)(mm)
UIS2 objective lens	MPLFLN2.5X	0.08	10.7
	MPLFLN5X	0.15	20
LEXT dedicated objective lens (10X)	MPLFLN10XLEXT	0.3	10.4
	MPLAPON20XLEXT	0.6	1
LEXT dedicated objective lens (High performance type)	MPLAPON50XLEXT	0.95	0.35
	MPLAPON100XLEXT	0.95	0.35
	LMPLFLN20XLEXT	0.45	6.5
LEXT dedicated objective lens (Long working distance type)	LMPLFLN50XLEXT	0.6	5.2
	LMPLFLN100XLEXT	0.8	3.4
	SLMPLN20X	0.25	25
Super long working distance lens	SLMPLN50X	0.35	18
	SLMPLN100X	0.6	7.6
	LCPLFLN20XLCD	0.45	8.3-7.4
Long working distance for LCD lens	LCPLFLN50XLCD	0.7	3.0-2.2
	LCPLFLN100XLCD	0.85	1.2-0.9

Application Software

Standard Software
OLS51-BSW

Data acquisition app

Analysis app (simple analysis)

Motorized stage package application*1 **OLS50-S-MSP**

Advanced analysis application*2 **OLS50-S-AA**

Film thickness measurement application **OLS50-S-FT**

Auto edge measurement application **OLS50-S-ED**

Particle analysis application **OLS50-S-PA**

Experimental total assist application **OLS51-S-ETA**

Sphere/cylinder surface angle analysis application **OLS50-S-SA**

*1 Including Auto-stitching data acquisition and Multi-area data acquisition functions.

*2 Including Profile analysis, Difference analysis, Step-height analysis, Surface analysis, Area/volume analysis, Line roughness analysis, Area roughness analysis and Histogram analysis.

Customized Solutions

Improve Your Productivity with a Customized OLS5100 Microscope

A microscopy workflow is almost never standard, so why should your microscope be?

Many inspection and measurement workflows involve, for example, large or tall specimens. Customized frames and stages make it easy to accommodate these samples.

To learn how the microscope's customized solutions can help you, contact your local Olympus representative or visit Olympus-IMS.com.



DSX1000 Digital Microscope

DSX digital microscopes are available to evaluate components used to create many devices and to check the quality of manufactured goods. Visit Olympus-IMS.com/microscope/dsx to learn more.



	LASER RADIATION DO NOT STARE INTO BEAM 1mW MAX 400-420nm CLASS 2 LASER PRODUCT (IEC/EN60825-1:2007) (IEC/EN60825-1:2014)	レーザー放射 ビームをのぞき込まないこと 1mW MAX 400-420nm クラス2 レーザ製品 (JIS C 6802:2014)	激光辐射 勿直视光束 最大输出功率 1mW 波长 400-420nm 2类激光产品 (GB7247.1-2012)

- **OLYMPUS CORPORATION is ISO14001 certified.**
- **OLYMPUS CORPORATION is ISO9001 certified.**
- All company and product names are registered trademarks and/or trademarks of their respective owners.
- Olympus, the Olympus logo, and LEXT are trademarks of Olympus Corporation or its subsidiaries.
- Performance characteristics and other values described in this brochure are based on Olympus evaluations as of September 2020, and are subject to change without notice.
- The information including guaranteed accuracy in this brochure is based on the condition set by Olympus. For details, refer to the Instruction Manual.
- Images on the monitors are simulated.
- Specifications and appearances are subject to change without any notice or obligation on the part of the manufacturer.
- Sample image of front page is a courtesy of KOSHIBU PRECISION CO.,LTD.

OLYMPUS[®]

OLYMPUS CORPORATION
Shinjuku Monolith, 2-3-1, Nishi-Shinjuku, Shinjuku-ku, Tokyo 163-0914, Japan