

WATSON-MARLOW BREDEL E-MANUALS

m-621cc-gb-03

Watson-Marlow 621 close-coupled pumps



Clickable index

1. Declaration of conformity
2. Declaration of incorporation
3. Warranty
4. Information for returning pumps
5. Safety
6. Do's and do not's
7. Installation
8. Start-up
9. Troubleshooting
10. AC motor maintenance
11. Gearbox maintenance - Simplex (single pumphead) units
12. Gearbox maintenance - Duplex (twin pumphead) units
13. Varmeca drives
 - 13.1 Varmeca drives: installation
 - 13.2 Varmeca drives: connections
 - 13.3 Varmeca drives: cables and protection devices
 - 13.4 Varmeca drives: commissioning / start-up
 - 13.5 Varmeca drives: single phase connection diagram
 - 13.6 Varmeca drives: keypad indicator light display
 - 13.7 Varmeca drives: Varmeca-30 specifications
 - 13.8 Varmeca inverter factory settings
 - 13.9 Varmeca care and maintenance
14. Air motors
15. Pump specification
16. 620RE, 620RE4 and 620R Key safety information
17. 620RE, 620RE4 and 620R Safe-guarding
18. 620RE, 620RE4 and 620R Pumping conditions
19. 620RE, 620RE4 and 620R Pump installation
20. 620RE, 620RE4 and 620R General operation
21. 620RE and 620RE4 tube element loading
22. 620RE, 620RE4 and 620R Continuous tube loading
23. 620RE, 620RE4 and 620R Tube element or continuous tube removal
24. 620RE, 620RE4 and 620R Maintenance
25. 620RE, 620RE4 and 620R CIP and SIP
26. Pumphead spares
27. Technical data
28. Motor wiring for three-phase motors
29. Dimensions in mm
30. 620R product codes
31. 620RE and 620RE4 LoadSure product codes
32. Trademarks and disclaimer
33. Patient-connected use: warning
34. Publication history
35. Decontamination certificate

Double clicking anywhere in the manual will take you back to this index.



1 Declarations of conformity



 When this pump unit is used as a stand-alone pump it complies with: Machinery Directive 2006/42/EC, EMC Directive 2004/108/EC.



Watson-Marlow Limited
Falmouth
Cornwall
TR11 4RU
England



Declaration of Conformity

Description	600 Series ATEX compliant configured peristaltic pumps
Product codes	621D, (F, V, X & P variant), ATEX close coupled pumps, configured with 620 RA, REA, or RE4A ATEX pump heads.
Conformity	This document certifies that the above equipment complies with the requirements of Directive 94/9/EC (the "ATEX" directive).
Rating	The pumps are rated as Group II, Category 2 equipment, with a T4 temperature classification, for use in gas based environments. 
Standards	EN13463-1:2001 EN13463-5
Manufacturer	Watson-Marlow Bredel Pumps, TR11 4RU, England.
Notified body	Full details of the conformity assessment procedure can be found in the technical reference file, "ATEX-600-CP". In accordance with the requirements of Directive 94/9/EC a copy of this file has been archived with the following notified body: Intertek (CE 0359), KT22 7SB, England.
Date	15 th November 2004
Signature	 Christopher Gadsden, Managing Director, Watson-Marlow Limited

2 Declaration of incorporation

When this pump unit is to be installed into a machine or is to be assembled with other machines for installations, it must not be put into service until the relevant machinery has been declared in conformity with the Machinery Directive 2006/42/EC.

Responsible person: Christopher Gadsden, Managing Director, Watson-Marlow Limited, Falmouth, Cornwall TR11 4RU, England. Telephone +44 (0) 1326 370370 Fax +44 (0) 1326 376009.

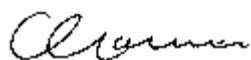

3 Two year warranty

Watson-Marlow Limited warrants, subject to the conditions below, through either Watson-Marlow Limited, its subsidiaries, or its authorised distributors, to repair or replace free of charge, including labour, any part of this product which fails within two years of delivery of

the product to the end user. Such failure must have occurred because of defect in material or workmanship and not as a result of operation of the product other than in accordance with the instructions given in this manual.

Conditions of and specific exceptions to the above warranty are

- Consumable items such as tubing and rollers are excluded.
- Products must be returned by pre-arrangement carriage paid to Watson-Marlow Limited, its subsidiaries, or its authorised distributor.
- All repairs or modifications must have been made by Watson-Marlow Limited, its subsidiaries, or its authorised distributors or with the express permission of Watson-Marlow Limited, its subsidiaries, or its authorised distributors.
- Products which have been abused, misused, or subjected to malicious or accidental damage or electrical surge are excluded.

Warranties purporting to be on behalf of Watson-Marlow Limited made by any person, including representatives of Watson-Marlow Limited, its subsidiaries, or its distributors, which do not accord with the terms of this warranty shall not be binding upon Watson-Marlow Limited unless expressly approved in writing by a Director or Manager of Watson-Marlow Limited.

4 Information for returning pumps

Equipment which has been contaminated with, or exposed to, body fluids, toxic chemicals or any other substance hazardous to health must be decontaminated before it is returned to Watson-Marlow or its distributor. A certificate included at the rear of these operating instructions, or signed statement, must be attached to the outside of the shipping carton. This certificate is required even if the pump is unused. If the pump has been used, the fluids that have been in contact with the pump and the cleaning procedure must be specified along with a statement that the equipment has been decontaminated.

5 Safety

In the interests of safety, this pump and the tubing selected should only be used by competent, suitably trained personnel after they have read and understood this manual, and considered any hazard involved.

Any person who is involved in the installation or maintenance of this equipment should be fully competent to carry out the work. In the UK this person should also be familiar with the Health and Safety at Work Act 1974.



This symbol, used on the pump and in this manual, means: Caution, risk of electric shock.



This symbol, used on the pump and in this manual, means: Caution, refer to accompanying documents.



This symbol, used on the pump and in this manual, means: Do not allow fingers to contact moving parts.



Fundamental work with regard to lifting, transportation, installation, starting-up, maintenance and repair should be performed by qualified personnel only. Make absolutely sure that no voltage is applied at all whilst work is being carried out on the geared motor. The motor must be secured against accidental start.

6 Do's and do not's

Do not build a pump into a tight location without adequate airflow around the pump.

Do not strap the control and mains power cables together.

Do keep delivery and suction tubes as short and direct as possible - though ideally not shorter than 1m - and follow the straightest route. Use bends of large radius: at least four times the tubing diameter. Ensure that connecting pipework and fittings are suitably rated to handle the predicted pipeline pressure. Avoid pipe reducers and lengths of smaller bore tubing than the pumphead section, particularly in pipelines on the suction side. Any valves in the pipeline (not usually needed) must not restrict the flow. Any valves in the flow line must be open when the pump is running.

Do use suction and delivery pipes equal to or larger than the bore of the tube in the pumphead. When pumping viscous fluids use pipe runs with a bore several times larger than the pump tube.

Do ensure that on longer tube runs at least 1m of smooth bore flexible tubing is connected to the inlet and discharge port of the pumphead to help to minimize impulse losses and pulsation in the pipeline. This is especially important with viscous fluids and when connecting to rigid pipework.

Do site the pump at or just below the level of the fluid to be pumped if possible. This will ensure flooded suction and maximum pumping efficiency.

Do keep the pumphead track and all moving parts clean and free from contamination and debris.

Do run at slow speed when pumping viscous fluids. Flooded suction will enhance pumping performance in all cases, particularly for materials of a viscous nature.

When using Marprene or Bioprene continuous tubing, do re-tension the tube after the first 30 minutes of running.

Tube selection: The chemical compatibility lists published in Watson-Marlow publications are guides. If in doubt about the compatibility of a tube material and the duty fluid, request a Watson-Marlow tube sample card for immersion trials.

7 Installation

Pump

Site the pump on a flat, horizontal, vibration-proof surface allowing a free flow of air around it. Ensure there is 0.5m of straight tubing before the pumphead inlet and after the pumphead outlets. Close coupled simplex pumps will require bolting down with four M8 bolts through the gearbox foot mounting holes.

AC motor

- Ensure that mains voltage/frequency are in accordance with motor nameplate information.
- Secure protective conductor connections.
- If a three-phase motor is running in the wrong direction, interchange any two phases.
- Close unused cable entrance holes and the terminal box itself in a dust and watertight manner.
- A current overload relay should be fitted to a contact breaker. Connect the motor in accordance with the wiring diagram which will be found in the motor terminal box.
- When a thermal protection switch is fitted in the motor, the leads will be found in the motor terminal box. They should be connected to stop the pump if the switch operates. The switch will open circuit at an over temperature condition. See below for the connection of the drive motor showing possible ancillary switches and protections.

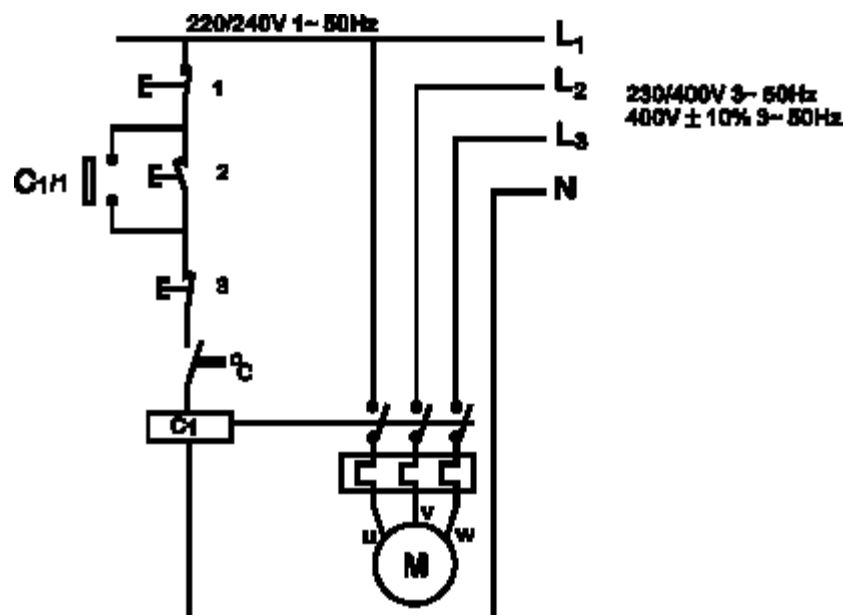

1. Emergency stop
2. Start
3. Stop

The ancillary switches are rated to 220/240V 1ph 50Hz. The Start contact should have a sprung return which will disengage following energisation of the coils C1 and C1/1.



Ensure that an emergency stop switch is fitted within reach of the pump.



Do not under any circumstances wire switches directly across any of the phases of a three-phase supply. If in doubt disconnect the pump immediately!



Do not connect ancillary switches to the terminal box of a flameproof motor unless the switch has a suitable Exd rating for the zone area in which it is to be mounted.

8 Start-up

Before starting and after prolonged storage of the gear units, remove the plug from the vent screw on top of the casing to avoid excessive pressure in the gearbox, which may cause leakage at the shaft seals.

9 Troubleshooting

Should the pump fail to operate, make the following checks to determine whether or not servicing is required.

- Check the electrical supply is available at the pump.
- Check that the pump is not stalled by incorrect fitting of tubing.



Always check to ensure that an Exd motor gearbox is suitably rated for the hazardous zone area in which it is to be mounted. Exd motors should only be installed by Exd qualified personnel.



Any deviation from normal operating conditions (increased power consumption, temperature, vibrations, noise) or warning signals by monitoring equipment suggest malfunction. Inform the responsible maintenance personnel at once to prevent the trouble

from worsening. If in doubt disconnect the pump immediately.

10 AC motor maintenance

- Remove any dust deposits from the fan cover to avoid overheating.
- Ensure that the bearing cage is packed to about 1/3 with evenly distributed lubricating grease.
- Select the correct lubricating grease from the table in the back of this operating instruction.

11 Gearbox maintenance - Simplex (single pumphead) units

- Change lubricant every 10,000 working hours or after 2 years.
- Combine a lubricant change with a thorough cleaning of the gear unit.
- Extreme working conditions (high air humidity, aggressive media and large temperature variations) will reduce the interval between lubricant changing intervals.
- Select the correct lubricating oil from the table in the back of this operating instruction.

12 Gearbox maintenance - Duplex (twin pumphead) units

The gearbox is filled for life with synthetic lubricant so no maintenance is required.

13 Varmeca drives

Varmeca drives: overview

The Varmeca drive is an IP65 integrated electronically-variable speed drive fitted to a standard enclosure IP55 motor gearbox. Standard Varmeca drives are single-phase but three-phase Varmecas are available.

Standard Varmeca drives are set up for manual control with the run command enabled. Current will be applied directly to the motor as soon as mains power is switched on. Subsequently, speed, direction of rotation and stop control can be achieved from the control knob and keypad.

For information on how to set up the Varmeca for remote control, please refer to the Leroy Somer Varmeca-30 manual.



This Varmeca-30 must be connected to an approved earth terminal. It is imperative that the equipment is powered via an isolating device and a circuit-breaking device (power contactor) which can be controlled by an external safety system (emergency stop, fault detector).

The Varmeca-30 is fitted with safety devices which stop the motor in the event of a fault. The motor can become jammed for mechanical reasons. Voltage fluctuations and power cuts may also stop the motor.

Removing the cause of a shutdown can lead to **restarting, which may be dangerous for certain installations**. It is essential that the user guards against the motor restarting after shutdown, if this is undesirable.

13.1 Varmeca drives: installation

- The standard Varmeca integrated drive requires no connection other than to the mains power supply.
- The Varmeca motor fan cools the whole unit. Make sure that the ventilation air inlet is

free of obstruction.

- It is the responsibility of the owner or user to ensure that the installation, operation and maintenance of the inverter complies with health and safety regulations of the relevant country of use.



Before carrying out any work, disconnect and lock the drive power supply. For single phase units, wait two minutes to make sure that the capacitors have fully discharged. After connection work, make sure that the seals are firmly in place, and the screws and cable glands are watertight to ensure IP65 protection. Clear any condensation from the drain holes at the bottom of the motor.

13.2 Varmeca drives: connections

- The voltages on the power terminal blocks and the cables connected to them may cause fatal electric shocks. The drive stop function does not protect against these high voltages.
- The drive power supply must be protected against overloads and short circuits.
- It is vital to respect the rating of protection devices.
- Connections should be made with copper conductors only.

13.3 Varmeca drives: cables and protection devices

- Circuit breakers must be of the D-curve type suitable for a motor with an inverter.
- Comply with the size of protection (gl) fuses given in the table below.
- The cable size may vary according to legislation applicable in the country of use, which will take precedence over the values given in the table below without exception.

	Power	VMA rating	Current (A)	gl fuses or circuit breaker (A)	Cable (sq mm)
230V/1/50/60Hz	0.37kW 1/2HP	A 21M-037	4	10	1.5
110V/1/50/60Hz	0.37kW 1/2HP	A 22M-037	9	16	2.5

NB: The mains current value is a typical value which depends upon the source impedance. The higher the impedance, the lower the current. The fuses (UL approved) are intended for installations capable of delivering 5,000A maximum at 480V.

13.4 Varmeca drives: commissioning / start-up

- Remove the cover and connect a suitably rated mains cable via the cable gland to connection points L1, L2 and PE (earth) of the Varmeca terminal block.
- Secure the connection cover and cable gland into position, ensuring that the IP65 sealing is not compromised.



The Varmeca must not be switched on with the connection cover removed.



The motor *Run* command has been enabled: the motor will start as soon as it is switched on.

- Power-up at the mains: the green indicator lamp lights and remains on continuously.
- Start rotation by pressing a direction button for one second.
- Set the speed reference using the side control knob, adjusting speed between 10Hz and 80Hz. The speed control knob is calibrated in percentages of maximum speed.
- Press the *Stop* button to stop the unit.

Varmeca drives fitted with electrical interlock pumpheads

Commissioning / start-up: as standard Varmeca units.

If the guard switch is activated:

- Press the *Stop* button twice to reset the unit after the pumphead guard has been closed
- Re-start rotation by pressing a direction button for one second

13.5 Varmeca drives: single phase connection diagram

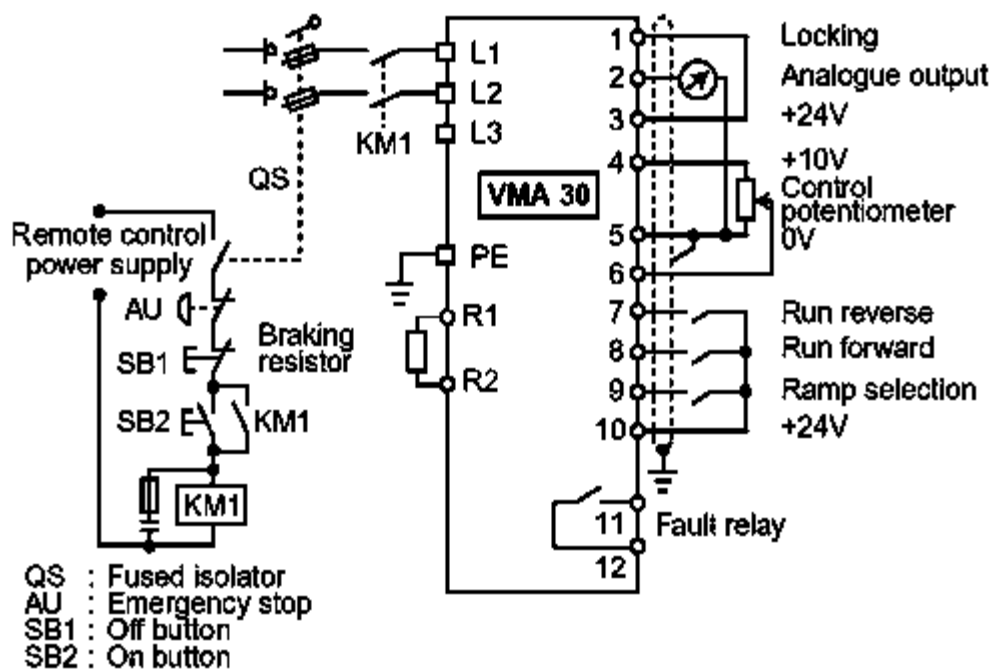

Before switching on the Varmeca-30 motor, check that electrical connections are correct and that any moving parts are mechanically protected. The Varmeca-30 must not be switched on with the protective cover removed.

13.6 Varmeca drives: keypad indicator light display

Steady green light	Mains connected
Flashing green light	Motor current overload
Flashing green and red lights	Motor current limit
Flashing red light	Fault: under/over voltage
Steady red light	Fault: short circuit; locked motor rotor; faulty winding insulation; I ² t overheating; or internal fault

13.7 Varmeca drives: Varmeca-30 specifications

Power supply	Single phase, 208V -10% to 240V +10%, 50/60Hz ±2% 110V -10% to 120V +10%, 50/60Hz ±2%
Power range	0.37kW, 1/2HP
Maximum hourly mains stop/starts	10
Overload	150% of nominal current for 60 seconds, 10 times per hour

Efficiency	97.5% motor efficiency
Filter type	Class B EMC filter (domestic and light industrial level)
Motor frequency variation range	10Hz-80Hz at constant torque
Enclosure	IP65: Varmeca drive; IP55: motor
Storage temperature	-40C to 70C (IEC 68.2.1), -40F to 158F
Operating temperature	-20C to 50C, -4F to 122F; power derated by 1% per degree C above 40C, 1% per 1.8 degrees F above 104F
Altitude	Up to 1000m without derating
UL standard	Conforming to UL508c (E211799)
Weight	21kg, 46lb

13.8 Varmeca inverter factory settings

The Watson-Marlow 621VI/RC and 621VI/R2C inverter default settings are listed in the table below. For more information on each parameter and its options, consult the Leroy-Somer Varmeca-30 operating instructions.

Parameter	Set value	Possible settings	Parameter	Set value	Possible settings
P01 F MIN	8	8Hz	P15 VP1-1		50Hz
P02 REF 0V - 4mA	8	8Hz	P16 VP2-1 VP1-2		60Hz
P03 F MAX	80	80Hz	P17 VP2		40Hz
P04 REF 10V - 20mA	80	80Hz	P18 VP3-2		70Hz
P05 ACCEL	3	3s	P19 ROTATION	FORWARD	FORWARD
P06 DECEL	3	3s	P20 SELECT 3		OUTPUT N
P07 STOP MODE	RAMP	RAMP	P21 PI K PRO		10
P08 Un MOT	400V	400V	P22 PI K INT		10
P09 FN MOT	50Hz	50Hz	P23 F MOT		-
P10 U / F	C	C: 0.25-1.1kW; D: 1.5-7.5kW	P24 I MOT		-
P11 BOOST	8%	Adapted to motor according to power	P25 FAULT		0
P12 OVERBOOST	20%	Adapted to motor according to power	P26 STOP F min		0
P13 F PWM	11	11: 0.25-2.2kW; 8: 3-4kW	P27 LOG CDC-VMA		-
P14 CONFIG	Standard	Standard	P28 CAL MOT	21M 025:520	Adapted according to motor power

13.9 Varmeca care and maintenance

- Temperature variations and excessive humidity encourage the formation of condensation. If this occurs, the condensation drain plugs at the bottom of the motor should be removed, even in a very humid atmosphere.
- No specific servicing is required for Varmeca-30 motors, apart from regularly removing

- dust from the fan grille and the cooling fins at the bottom of the unit.
- Dismantling the Varmeca-30 while it is under warranty will invalidate the warranty.

14 Air motors



The air motor is designed for air only. Do not allow corrosive, flammable or explosive gases or particulate material to enter the motor. Water vapour, oil-based contaminants, or other liquids must be filtered out. The recommended air pressure should not exceed 100 PSIG maximum.



Always disconnect the air supply before servicing.

Installation

A muffler is supplied with the air motor, but not installed. Install a moisture trap and filter in the air line ahead of the motor. If condensates need to be flushed out of the motor, use clean, dry air at low pressure. For efficiency of output and speed control, use air lines of the same size or next pipe size larger than the intake port of the motor. A four-way valve which can be connected by piping to both air ports of the motor will make reversing possible. Use a pressure regulator or a simple shut-off valve to obtain desired power and conserve air to regulate speed and torque.

Lubrication

Use a detergent SAE #10 automotive engine oil. Lubrication is necessary for all moving parts and rust prevention. We recommend that an automatic air lubricator be installed in the air line just ahead of the motor. The lubricator should be adjusted to feed one drop of oil for every 50-75 CFM of air going through the motor.

- **Manual lubrication** Add 10-20 drops of oil every eight hours of operation through the inlet port while the pump is shut down.
- **Automatic lubrication** An In-line oiler should be adjusted to feed one drop per minute for high speed or continuous duty use. Do not overfeed oil as contamination of the exhaust air may occur.

Troubleshooting

Reason	Low torque	Low speed	Won't run	Runs hot	Runs well then slows
Dirt, foreign material	•	•	•		
Internal rust	•	•	•		
Misalignment	•	•	•	•	•
Insufficient air pressure	•	•			
Air line too small		•			
Restricted exhaust		•			•
Poor lubrication	•	•	•	•	
Jammed machine	•	•	•		•
Compressor too small		•			•
Compressor too far from unit		•			•

15 Pump specification

Control range

See pump specification label

Voltage/frequency	See pump specification label
Power consumption	See pump specification label
Operating temperature range	5°C to 40°C
Storage temperature range	-40°C to 70°C
Noise	<75dBA at 1m
Standards	EN60529 (IP55) Machinery Directive: 2006/42/EC EMC Directive: 2004/108/EC

Specific drive performance details such as loaded drive speed variation against mains supply voltage fluctuation and drive stability from a cold start to normal operating temperature are available on request. For further information please contact Watson-Marlow Technical Support Centre.

16 620RE, 620RE4 and 620R Key safety information



Before opening the pumphead guard please ensure that the following safety directions are followed.

- For close-coupled drives, ensure that the pump is isolated from mains voltage.
- Ensure that there is no pressure in the pipeline.
- If a tube failure has occurred, ensure that any product in the pumphead has been allowed to drain through the controlled waste to a suitable drain.
- Ensure that protective clothing and eye protection are worn if hazardous products are being pumped.

17 620RE, 620RE4 and 620R Safe-guarding

- Primary safety on 620 series pumps is provided by the tool-lockable pumphead guard. On electrically-powered cased 600 series pumps, secondary (backup) protection is provided in the form of an electrical interlock which stops the pump if the pumphead guard is opened (and only for so long as the guard is opened). The electrical interlock on cased pumps should never be used as primary protection. Always disconnect the mains power supply to the pump before opening the pumphead guard.
- Only primary protection through the tool-lockable guard is provided on pneumatically powered 621 close-coupled pumps.
- Primary protection through the tool-lockable pumphead guards is provided as standard on 621 series industrial AC motors. Secondary (backup) protection is available in the form of an electrical interlock which stops the pump if the pumphead guard is opened (and only for so long as the guard is opened). The electrical interlock on close-coupled pumps should never be used as primary protection. Always disconnect the mains power supply to the pump before opening the pumphead guard.

18 620RE, 620RE4 and 620R Pumping conditions

Pressure and viscosity

- All pressure values in this operating instruction, from which performance and life figures have been calculated relate to peak pipeline pressures.
- Although rated to 4 bar working pressure, this pump will generate in excess of 4 bar working pressure if pipeline restrictions are in place. In instances where it is critical that a working pressure of 4 bar is not exceeded, pressure relief valves should be installed in the pipeline.
- For pumping duties of 2-4 bar pressure, use standard STA-PURE tube elements or 73 Shore hardness Marprene/Bioprene. "TM" in the tube element's product order code denotes suitability for this pressure.
- To maintain performance at pressures above 2 bar, avoid running the pumphead

below 50 rpm. If low-flow, high-pressure operation is necessary, switching to a smaller tube is recommended.

- When pumping duties of 0-2 bar pressure, use 64 Shore hardness elements or the standard range of continuous peristaltic pump tubing.
- Viscosity handling is maximised by using 73 Shore hardness Marprene/Bioprene or STA-PURE tube elements in the pumphead.
- Ensure that there is always a minimum of one metre of smooth bore flexible tubing connected to the discharge port of the pumphead. This will help minimise any impulse losses and pulsation in the pipeline. This is especially important with viscous fluids and rigid pipework.

19 620RE, 620RE4 and 620R Pump installation

A correctly engineered installation will promote the best possible tube life, so please ensure that the following guidelines are followed:

- Avoid tight pipeline bends, pipe reducers and excessive lengths of smaller bore tubing than that in the pumphead, particularly in pipelines on the suction side.
- Ensure that connecting pipe work and fittings are suitably rated to handle the predicted pipeline pressure.
- If rigid pipework comes in close proximity to the pumphead, a drop-out section of pipework will simplify tube replacement. When using element pumpheads, ensure that a minimum of 1m of flexible interface pipework is connected between the pumphead and any rigid pipework.
- Ensure that the controlled waste blanking plug is in position if the controlled waste port is not in use. See below.



- It is advisable to use controlled waste pipe work if pumping hazardous, aggressive or abrasive fluids or products which will harden in contact with air.
- When connecting waste pipe work to the controlled waste port using the coupling adaptor supplied, ensure that there is adequate clearance underneath the pumphead. Waste pipe work should run to a suitable container or drain.
- The leak detector installation procedure is included in the leak detector kit.
- If unsure of an installation please contact your local Watson-Marlow Technical Support Office for further assistance.

20 620RE, 620RE4 and 620R General operation

Opening the pumphead guard

- Unlock the guard with a 5mm Allen key or a screw driver.
- Open the guard to its full extent. This creates the maximum clearance between the tube ports and guard to remove the tubing.

Engaging/disengaging the rollers

- The extent of travel of the roller release levers is indicated below. Do not try and force the levers beyond their normal extent of travel as this will damage the rotor.
- To engage the rollers snap the roller release levers counter clockwise making sure that the rollers locked out against the tubing. To disengage the rollers, snap the release levers clockwise to their disengaged position. For high pressure tubing elements or four roller pumpheads, the 5mm Allen key can be used to aid leverage when engaging/disengaging the rollers with the release levers.



Make sure that fingers are clear of the front face of the rotor hub when using the roller release levers.



Pre-load checks

- Before loading tubing, ensure that all rollers rotate freely, that the tube ports and location grooves are clean and that if in use, the controlled waste pipe work is free of any obstructions.

Closing the pumphead guard and start-up

- Ensure that the guard seal is clean, replacing it if necessary.
- Ensure that the rollers are engaged and locked out against the tubing
- Close the guard and push it against the track until the latch engages.
- Connect suitable pipe work to the pumphead using the appropriate connectors for the tube element.

Continuous tubing clamp location in 620R pumpheads

- Select the appropriate tube clamp set for the tubing size to be used.
- Locate the two "U"-shaped track clamp halves into the pumphead ports (The "U"-shape ensures correct loading)
- Locate the corresponding guard clamp halves which have raised "T" locating sections, into the slots on the inner guard face above and below the guard hinge. Push and slide into their locked position.
- Closing the guard will align the two halves of the clamp around the tubing.

21 620RE and 620RE4 tube element loading

- 620RE element pumpheads are factory set to accept Watson-Marlow LoadSure tube elements. Pumping performance will be adversely affected if LoadSure elements are not used.
- Disengage rollers
- Locate one of the "D"-shaped flanges into the lower port. (The "D" flange ensures that the element can only be loaded correctly).
- Wrap the tube element around the disengaged rollers of the rotor.
- Locate the second "D"-shaped flange into the upper port.
- Ensure the flat face of each "D" flange sits flush to the flange sealing face of the track.
- Engage rollers
- Close the guard and push it against the track until the latch engages.

Tube element loading



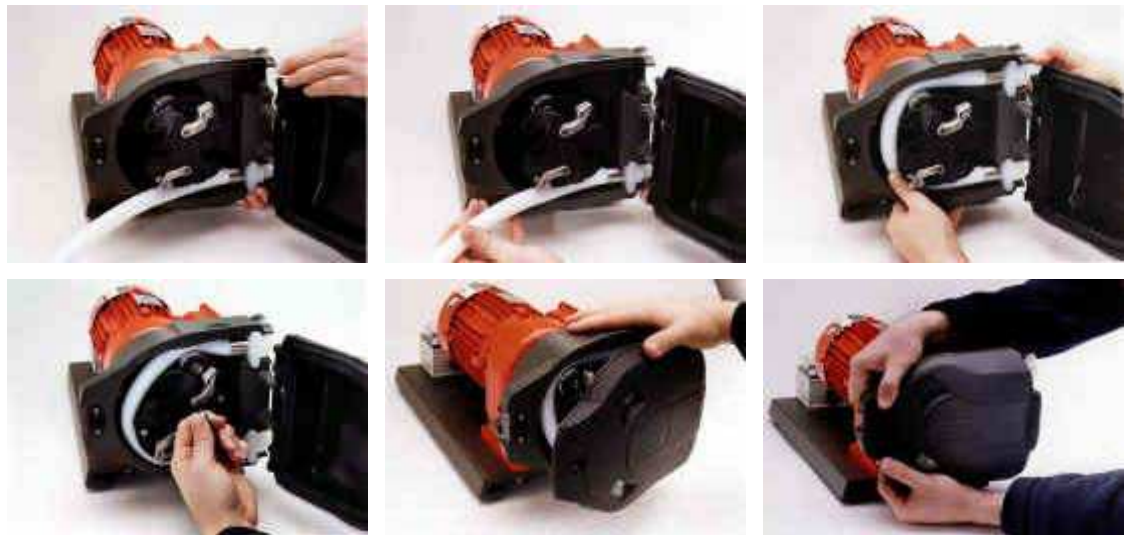

22 620RE, 620RE4 and 620R Continuous tube loading

- 620R continuous tubing pumpheads are factory set to accept Watson-Marlow 600 series 3.2mm wall tubing. Pumping performance will be adversely affected if Watson-Marlow tubing is not used.
- Select the tube clamp set which is correct for the tubing size to be used.
- Disengage rollers
- Locate one end of the tubing into the lower port "U" clamp and hold in position.
- Wrap the tubing tightly around the retracted rollers, making sure that there is no twisting through its length.
- Locate the other end of the tubing into the upper port "U" clamp.
- Hold both ends of the tubing in one hand maintaining tension around the rollers.
- Engage rollers
- Close the guard and push it against the track until the latch engages
- Ensure that continuous tubing is not loosely clamped at the pumphead ports.
- Ensure that when the pump is re-started all of the rollers have re-engaged. A roller which has not re-engaged will "click" continuously. No damage will occur if this happens but the roller should be re-engaged manually using the 5mm Allen key. Please refer to the Troubleshooting section.

Continuous tube loading



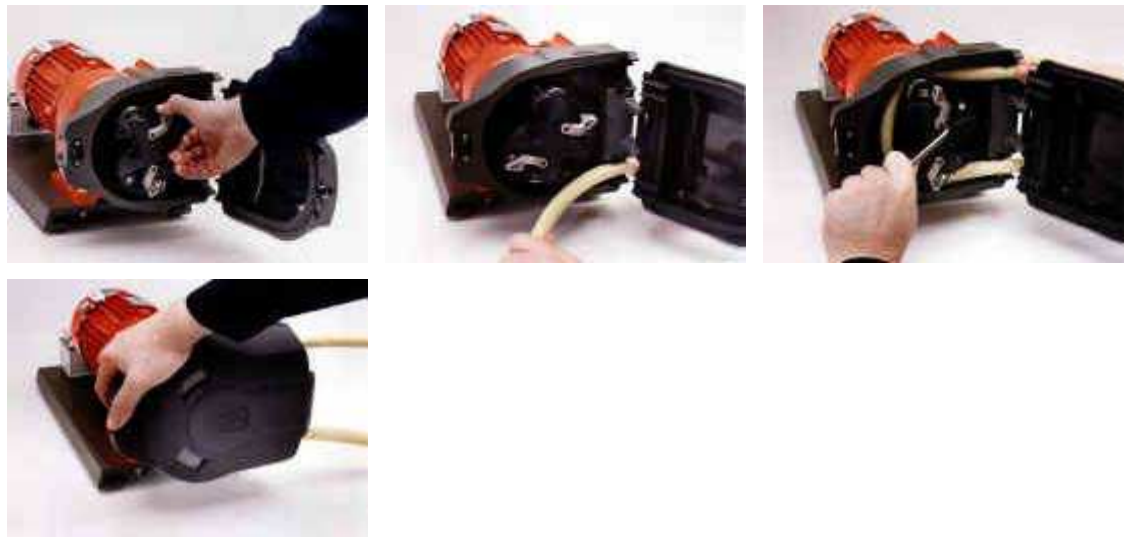

23 620RE, 620RE4 and 620R Tube element or continuous tube removal

- Unlock the guard and disengage the rollers.
- Disconnect the tubing from the external pipeline.
- Remove the tubing from the pumphead.

24 620RE, 620RE4 and 620R Maintenance

Scheduled maintenance

- The stainless steel pumping rollers run on sealed bearings and do not require lubrication.
- Remove the rotor and lubricate the follower rollers and roller engaging mechanisms with a lithium-based grease. This should be carried out every six months for intermittent duties and every three months for 24 hour duties.
- If fluid is spilled inside the pumphead, flush the pumphead out with water and mild detergent as soon as possible. If specific cleaning agents are required to clean the spillage, please consult Watson-Marlow Technical Support Office before proceeding, in order to confirm chemical compatibility.
- If the rotor needs to be removed, refer to the guidelines below.

Roller adjustment

620 pumpheads have provision for adjustment to reset the roller/track gap to compensate for wear after extended service in arduous applications.

Roller/track gaps can **only** be accurately judged without tubing in the pumphead. The gap should be **4.6mm** for 3.2mm wall tubing and **5.5mm** for LoadSure elements.

If the gap is more than 0.2mm greater than these dimensions, the following may be carried out:

- Note the number on the roller arm to which the engraved line on the hexagon-headed main roller pin corresponds.
- Remove the circlip (snap-ring) and roller pin.
- Relocate the main roller pin, resetting the engraved line to one number lower. For example, if the engraved line was at "-1", reset it to "-2" to reduce the roller track gap.
- Ensure the roller pin is correctly seated into the roller arm thrust washer. Replace the circlip.

Rotor removal and re-location

- Remove the rotor cover and central locating bolt using a 5mm Allen key. Pull the rotor off the keyed shaft, remove the key and clean thoroughly. Do not use tools to lever the rear face of the rotor away from the inner face of the track, it should come

off by hand.

- To replace the rotor, locate the key into the keyway and apply a thin layer of grease over the shaft and key. Align the keyway of the rotor to the shaft key and slide the rotor into position, ensuring that a positive "stop" is achieved and ensure that the full length of the drive shaft is fitted into the rotor.
- Do not force the rotor into position. The rotor will slide into place easily if correctly aligned.
- Tighten the hexagonal locating bolt to a nominal torque of 10Nm using a 5mm Allen key.
- The rotor bolt, which is impregnated with "Loctite 218" thread lock, should be subjected to a maximum of three removals/relocations before renewal. To avoid rotor bolt renewal after three removals, apply "Loctite 222" thread lock to the rotor thread before relocation. This is critical to ensure prolonged, secure location of the rotor hub to the drive shaft. **Failure to complete this action will invalidate the terms and conditions of the pumphead warranty.**
- Replace the rotor cover.

When closing the guard, check it does not make contact with the rotor. If it does, then the rotor has been fitted incorrectly. Re-open the guard, remove and refit the rotor, and close the guard.

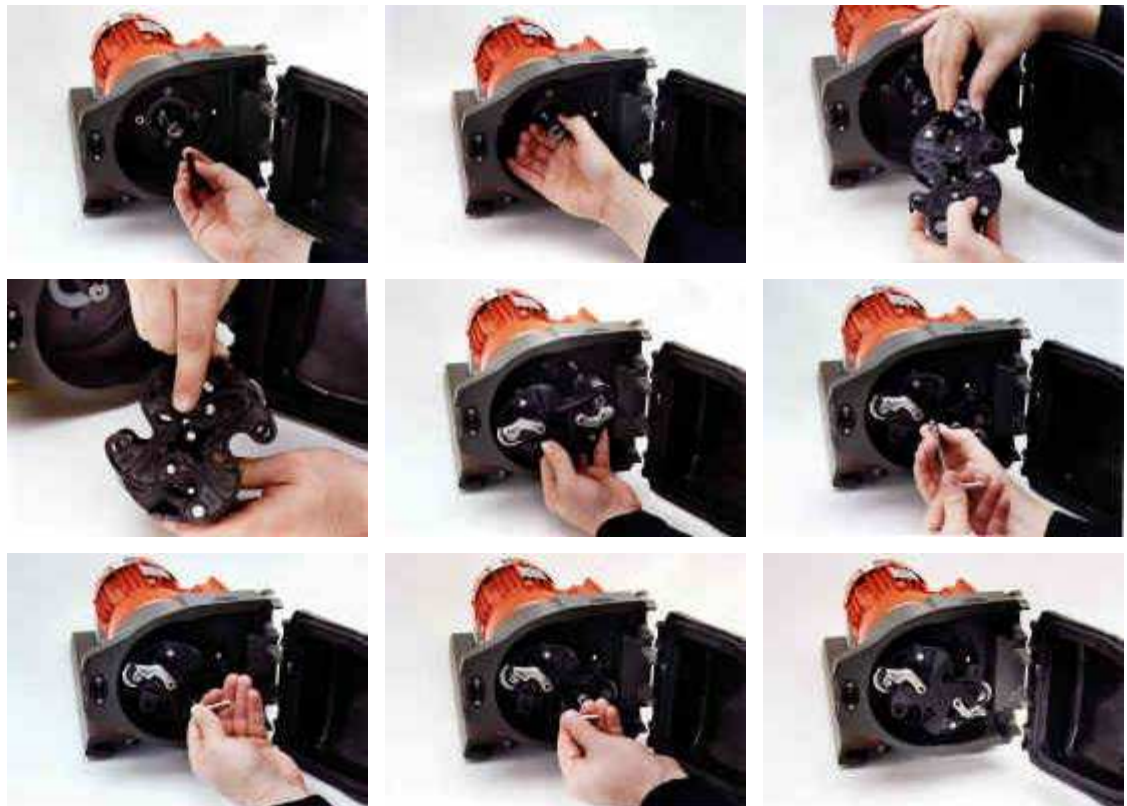

Track removal (close coupled AC motor gearboxes)

- Remove the rotor.
- Disconnect the controlled waste pipework if attached.
- Loosen the four track retaining screws using a Number 2 Pozzi-Driv screwdriver.
- Disconnect the mains interlock if connected to a mains contactor
- Withdraw the track fully from the gearbox.

Track re-location (close coupled AC motor gearboxes)

- Ensure that the track is clean.
- Fit the track over the gearbox boss.
- Align the track horizontally so that the location holes are aligned with the threaded gearbox holes.
- Tighten the four track retaining screws using a Number 2 Pozzi-Driv screwdriver.
- Re-connect the guard interlock controlled waste pipework if required.



25 620RE, 620RE4 and 620R CIP and SIP

General

- Unlock the guard and disengage the rollers within the tube zone.
- Close the guard and squeeze against the track until the latch clicks.
- Observe a 1m safety area.

CIP

- LoadSure tube elements and continuous tubing can be cleaned using CIP processes.
- Ensure that the tubing material is chemically compatible with the cleaning agent that is to be used.
- If cleaning agents are spilled over the pumphead, wash down immediately.
- Ensure that controlled waste pipework is fitted to allow a safe release of cleaning agent in the event of a tube failure.

SIP

- Only STA-PURE tube elements can be used in a steam in place sterilisation processes.
- STA-PURE tubing elements can be sterilised to 3A Class two and FDA minimum recommended standard which is 121C (250F) at 1bar (14.5 psi) saturated steam for 20 minutes.
- Monitor the process continuously .
- If a tube failure occurs, shut down the process. Do not touch the pumphead until a 20 minute cooling period has been observed.
- Ensure a 20 minute acclimatisation period is observed before running the pump following SIP.
- Ensure that controlled waste pipework is fitted to allow a safe release of steam in the event of a tube failure..
- Ensure a 1m safety zone is maintained around the pumphead during SIP cycles.

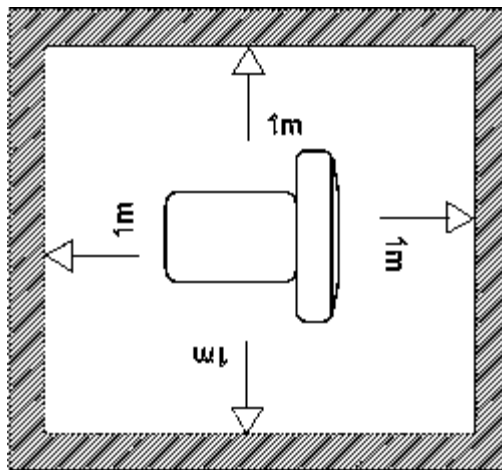

Ensure that the pumphead door is closed and locked before SIP cleaning commences.

26 Pumphead spares



Number	Spare	Description
1	069.4101.000	620RTC: continuous tubing clamp set
2	MR2052C	Oddie fastener
2	MR2053B	Clip: Oddie retainer
2	MR2054T	Oddie washer
2	SG0021	Oddie spring
2	CX0150	Oddie circlip (snap ring)
3	MRA0251A	Track assembly (continuous pumphead)
3	MRA0297A	Track assembly (element pumphead)
3	MR2000C	Track
4	MRA0249A	Roller assembly element pumphead

4	MRA0250A	Roller assembly continuous pumphead
5	MR2027T	Controlled waste threaded fitting 620R
6	MR2028M	Controlled waste port blanking plug
7	MR2018T	Hinge pin
8	MR2055M	Rotor cover
9	MR2021B	Seal - guard
10	MR2002M	Guard without latch and seal
11	MR2015T	Follower roller spindle
12	CX0148	Roller assembly circlip (snap-ring) E type 6 dia
12	MR2014T	Stainless steel roller spindle
12	MR2010T	Thrust washer
13	MR2096T	Controlled waste threaded fitting locking nut
14	MRA0320A	Rotor assembly 2-roller element
14	MRA0321A	Rotor assembly 4-roller element
14	MRA0322A	Rotor assembly 2-roller continuous
15	MR2058B	Grommet - door switch
16	XX0220	Key - metal
17	MR2029T	Cased drive MG605 shaft/rotor hub spacer
18	MR2059T	Adaptor - Bodine (white polypropylene ring)
19	FN0488	Cased drive track locating screws M6x10
20	FN0523	Close-coupled track locating screws M6x20
21	FN0581	Rotor locating washer M6
22	FN0520	Rotor locating bolt M6 x 25
23	TT0006	5mm Allen key
24	MA0017	Magnet
	MRA0268A	Cased drive door switch assembly
	MRA0279A	Close-coupled door switch assembly
	CN0187	Plug blanking 10.72M

27 Technical data

Performance envelope of the 620R, 620RE and 620RE4 mark II rotor

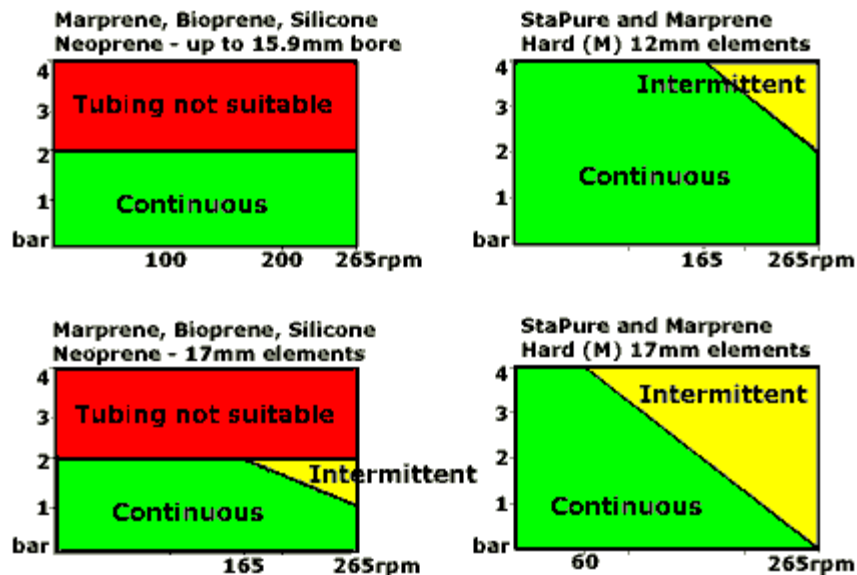

Gearbox lubricant

Mineral oil	EnergolGR-XP 220	Mobil-gear 630	Shell Omala Oel 220
	Energol GR-XP 100	Mobil-gear 629	Shell Omala Oel 100
	Bartran HV15	Mobil DTE 11M	Shell Tellus Oel T 15

621F/R, 621I/R, 621T/R - 250ml

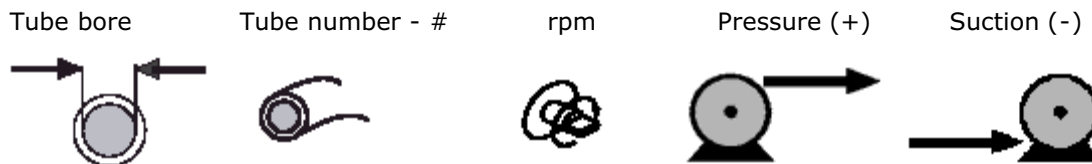

Flow rates









Note: Flow rates quoted have been rounded for simplicity, but are accurate to within 5% - well within the normal tubing-tolerance variation of flow rate. They should therefore be taken as a guide. Real flow rates in any application must be determined empirically.



620R



Flow rates: Marprene, Bioprene (l/min)					
	mm	6.4	9.6	12.7	15.9
	inch	1/4	3/8	1/2	5/8
	#	26	73	82	184
		7-78	0.09-1.0	0.18-2.0	0.28-3.1
8-76		0.10-1.0	0.20-1.9	0.32-3.0	0.42-4.2
8-77		0.10-1.0	0.20-1.9	0.32-3.1	0.42-4.2
8-83		0.10-1.1	0.20-2.1	0.32-3.3	0.42-4.5
15-146		0.20-1.9	0.38-3.7	0.60-5.8	0.80-7.8
17-83		0.22-1.1	0.43-2.1	0.68-3.3	0.90-4.5
26-261		0.34-3.4	0.65-6.5	1.0-10	1.4-11
47-237		0.61-3.1	1.2-5.9	1.9-9.5	2.5-11
50-251		0.65-3.3	1.3-6.3	2.0-10	2.7-11
52-259	0.68-3.4	1.3-6.5	2.1-10	2.8-11	

Flow rates: Marprene, Bioprene (USGPM)					
	mm	6.4	9.6	12.7	15.9
	inch	1/4	3/8	1/2	5/8
	#	26	73	82	184
	7-78	0.02-0.3	0.05-0.5	0.07-0.8	0.10-1.1
	8-76	0.03-0.3	0.05-0.5	0.08-0.8	0.11-1.1
	8-77	0.03-0.3	0.05-0.5	0.08-0.8	0.11-1.1
	8-83	0.03-0.3	0.05-0.5	0.08-0.9	0.11-1.2
	15-146	0.05-0.5	0.10-1.0	0.16-1.5	0.21-2.1
	17-83	0.06-0.3	0.11-0.5	0.18-0.9	0.24-1.2
	26-261	0.09-0.9	0.17-1.7	0.27-2.8	0.37-3.0
	47-237	0.16-0.8	0.31-1.6	0.50-2.5	0.67-2.9
	50-251	0.17-0.9	0.33-1.7	0.53-2.7	0.72-3.0
	52-259	0.18-0.9	0.34-1.7	0.55-2.7	0.75-3.0



Flow rates: Silicone (l/min)					
	mm	6.4	9.6	12.7	15.9
	inch	1/4	3/8	1/2	5/8
	#	26	73	82	184
	7-78	0.08-0.9	0.19-2.1	0.29-3.3	0.38-4.8
	8-76	0.10-0.9	0.22-2.1	0.34-3.2	0.44-4.7
	8-77	0.10-0.9	0.22-2.1	0.34-3.2	0.44-4.7
	8-83	0.10-1.0	0.22-2.2	0.34-3.5	0.44-5.1
	15-146	0.18-1.8	0.41-3.9	0.63-6.1	0.83-9.3
	17-83	0.20-1.0	0.46-2.2	0.71-3.5	0.95-5.1
	26-261	0.31-3.1	0.70-7.0	1.1-11	1.5-15
	47-237	0.56-2.8	1.3-6.4	2.0-10	2.8-14
	50-251	0.60-3.0	1.4-6.8	2.1-11	3.0-14
	52-259	0.62-3.1	1.4-7.0	2.2-11	3.1-15

Flow rates: Silicone (USGPM)					
	mm	6.4	9.6	12.7	15.9
	inch	1/4	3/8	1/2	5/8
	#	26	73	82	184
	7-78	0.02-0.2	0.05-0.6	0.08-0.9	0.10-1.3
	8-76	0.03-0.2	0.06-0.5	0.09-0.8	0.12-1.2
	8-77	0.03-0.2	0.06-0.5	0.09-0.9	0.12-1.3
	8-83	0.03-0.3	0.06-0.6	0.09-0.9	0.12-1.4
	15-146	0.05-0.5	0.11-1.0	0.17-1.6	0.22-2.5
	17-83	0.05-0.3	0.12-0.6	0.17-0.9	0.25-1.4
	26-261	0.08-0.8	0.19-1.9	0.29-2.9	0.39-3.9
	47-237	0.15-0.8	0.34-1.7	0.46-2.6	0.73-3.7
	50-251	0.16-0.8	0.36-1.8	0.55-2.8	0.78-3.8

	52-259	0.16-0.8	0.37-1.8	0.58-2.9	0.82-3.9
Flow rates: Neoprene, STA-PURE (l/min)					
	mm	6.4	9.6	12.7	15.9
	inch	1/4	3/8	1/2	5/8
	#	26	73	82	184
	7-78	0.08-0.9	0.18-2.0	0.28-3.1	0.43-4.8
	8-76	0.10-0.9	0.20-1.9	0.32-3.0	0.49-4.6
	8-77	0.10-0.9	0.20-1.9	0.32-3.1	0.49-4.7
	8-83	0.10-1.0	0.20-2.1	0.32-3.3	0.49-5.1
	15-146	0.18-1.8	0.38-3.7	0.60-5.8	0.92-8.9
	17-83	0.20-1.0	0.43-2.1	0.68-3.3	1.0-5.1
	26-261	0.31-3.1	0.65-6.5	1.0-10	1.6-16
	47-237	0.56-2.8	1.2-5.9	1.9-9.51	2.9-14
	50-251	0.60-3.0	1.3-6.3	2.01-10	3.1-15
	52-259	0.62-3.1	1.3-6.5	2.1-10	3.2-16



	52-259	0.16-0.8	0.37-1.8	0.58-2.9	0.82-3.9
Flow rates: Neoprene, STA-PURE (USGPM)					
	mm	6.4	9.6	12.7	15.9
	inch	1/4	3/8	1/2	5/8
	#	26	73	82	184
	7-78	0.02-0.2	0.05-0.5	0.07-0.8	0.11-1.3
	8-76	0.03-0.2	0.05-0.5	0.08-0.8	0.13-1.2
	8-77	0.03-0.2	0.05-0.5	0.08-0.8	0.13-1.2
	8-83	0.03-0.3	0.05-0.5	0.08-0.9	0.13-1.3
	15-146	0.05-0.5	0.10-1.0	0.16-1.5	0.24-2.4
	17-83	0.05-0.3	0.11-0.5	0.18-0.9	0.27-1.3
	26-261	0.08-0.8	0.17-1.7	0.27-2.8	0.42-4.2
	47-237	0.15-0.8	0.31-1.6	0.50-2.5	0.76-3.8
	50-251	0.16-0.8	0.33-1.7	0.53-2.7	0.81-4.0
	52-259	0.16-0.8	0.34-1.7	0.55-2.7	0.84-4.2

620RE



Flow rates: Marprene TM, Bioprene TM (l/min)			
	mm	12	17
		LoadSure	LoadSure
	7-78	0.26-2.9	0.41-4.6
	8-76	0.30-2.8	0.47-4.5
	8-77	0.30-2.8	0.47-4.5
	8-83	0.30-3.1	0.47-4.9
	15-146	0.56-5.4	0.88-8.6
	17-83	0.63-3.1	1.0-4.9
	26-261	0.96-9.7	1.5-15

47-237	1.7-8.8	2.8-14
50-251	1.9-9.3	2.9-15
52-259	1.9-9.6	3.1-15



Flow rates: Marprene TM, Bioprene TM (USGPM)

	mm	12	17
		LoadSure	LoadSure
	7-78	0.07-0.8	0.11-1.2
	8-76	0.08-0.7	0.12-1.2
	8-77	0.08-0.8	0.12-1.2
	8-83	0.08-0.8	0.12-1.3
	15-146	0.15-1.4	0.23-2.3
	17-83	0.17-0.8	0.26-1.3
	26-261	0.25-2.6	0.40-4.1
	47-237	0.46-2.3	0.73-3.7
	50-251	0.49-2.5	0.78-3.9
	52-259	0.51-2.5	0.81-4.0

Flow rates: Marprene TL, Bioprene TL (l/min)



	mm	12	17
		LoadSure	LoadSure
	7-78	0.26-2.9	0.47-5.2
	8-76	0.30-2.8	0.54-5.1
	8-77	0.30-2.8	0.54-5.2
	8-83	0.30-3.1	0.54-5.6
	15-146	0.56-5.4	1.0-9.8
	17-83	0.63-3.1	1.1-5.6
	26-261	0.96-9.7	1.7-18
	47-237	1.7-8.8	3.2-16
	50-251	1.9-9.3	3.4-17
	52-259	1.9-9.6	3.5-17

Flow rates: Marprene TL, Bioprene TL (USGPM)



	mm	12	17
		LoadSure	LoadSure
	7-78	0.07-0.8	0.12-1.4
	8-76	0.08-0.7	0.14-1.4
	8-77	0.08-0.8	0.14-1.4
	8-83	0.08-0.8	0.14-1.5
	15-146	0.15-1.4	0.27-2.6
	17-83	0.17-0.8	0.30-1.5
	26-261	0.25-2.6	0.46-4.6
	47-237	0.46-2.3	0.84-4.2

50-251	0.49-2.5	0.89-4.5
52-259	0.51-2.5	0.92-4.6



Flow rates: Silicone (l/min)

	mm	12	17
		LoadSure	LoadSure
	7-78	0.27-3.0	0.43-4.8
	8-76	0.31-2.9	0.49-4.6
	8-77	0.31-3.0	0.49-4.7
	8-83	0.31-3.2	0.49-5.16
	15-146	0.58-5.7	0.91-8.9
	17-83	0.66-3.2	1.0-5.1
	26-261	1.0-10	1.6-16
	47-237	1.8-9.2	2.9-14
	50-251	1.9-9.7	3.0-15
	52-259	2.0-10	3.2-16

Flow rates: Silicone (USGPM)



	mm	12	17
		LoadSure	LoadSure
	7-78	0.07-0.8	0.11-1.3
	8-76	0.08-0.8	0.13-1.2
	8-77	0.08-0.8	0.13-1.2
	8-83	0.08-0.8	0.13-1.3
	15-146	0.15-1.5	0.24-2.3
	17-83	0.17-0.8	0.27-1.3
	26-261	0.27-2.7	0.42-4.2
	47-237	0.48-2.4	0.76-3.8
	50-251	0.51-2.6	0.80-4.0
	52-259	0.53-2.6	0.84-4.2

Flow rates: Neoprene, STA-PURE (l/min)

	mm	12	17
		LoadSure	LoadSure
	7-78	0.28-3.1	0.51-5.6
	8-76	0.32-3.0	0.58-5.5
	8-77	0.32-3.1	0.58-5.6
	8-83	0.32-3.3	0.58-6.0
	15-146	0.60-5.8	1.1-11
	17-83	0.68-3.3	1.2-6.0
	26-261	1.0-10	1.9-19
	47-237	1.9-9.4	3.4-17



50-251	2.0-10	3.6-18
52-259	2.1-10	3.8-19

Flow rates: Neoprene, STA-PURE (USGPM)



	mm	12	17
		LoadSure	LoadSure
	7-78	0.07-0.8	0.13-1.5
	8-76	0.08-0.8	0.15-1.4
	8-77	0.08-0.8	0.15-1.5
	8-83	0.08-0.9	0.15-1.6
	15-146	0.16-1.5	0.29-2.8
	17-83	0.18-0.9	0.32-1.6
	26-261	0.27-2.7	0.50-5.0
	47-237	0.49-2.5	0.90-4.5
	50-251	0.53-2.6	0.95-4.8
	52-259	0.55-2.7	0.99-4.9

620RE4

Flow rates: Marprene TM, Bioprene TM (l/min)



	mm	12	17
		LoadSure	LoadSure
	7-78	0.22-2.5	0.29-3.2
	8-76	0.25-2.4	0.33-3.1
	8-77	0.25-2.4	0.33-3.2
	8-83	0.25-2.6	0.33-3.4
	15-146	0.47-4.6	0.62-6.0
	17-83	0.54-2.6	0.70-3.4
	26-261	0.82-8.2	1.1-11
	47-237	1.5-7.5	1.9-9.8
	50-251	1.6-7.9	2.1-10
	52-259	1.6-8.2	2.1-11

Flow rates: Marprene TM, Bioprene TM (USGPM)



	mm	12	17
		LoadSure	LoadSure
	7-78	0.06-0.6	0.08-0.8
	8-76	0.07-0.6	0.09-0.8
	8-77	0.07-0.6	0.09-0.8
	8-83	0.07-0.7	0.09-0.9
	15-146	0.12-1.2	0.16-1.6
	17-83	0.14-0.7	0.19-0.9
	26-261	0.22-2.2	0.28-2.8

47-237	0.39-2.0	0.51-2.6
50-251	0.42-2.1	0.54-2.7
52-259	0.43-2.2	0.57-2.8



Flow rates: Marprene TL, Bioprene TL (l/min)

	mm	12	17
		LoadSure	LoadSure
	7-78	0.22-2.5	0.33-3.7
	8-76	0.25-2.4	0.38-3.6
	8-77	0.25-2.4	0.38-3.6
	8-83	0.25-2.6	0.38-3.9
	15-146	0.47-4.6	0.71-6.9
	17-83	0.54-2.6	0.80-3.9
	26-261	0.82-8.2	1.2-12
	47-237	1.5-7.5	2.2-11
	50-251	1.6-7.9	2.4-12
	52-259	1.6-8.2	2.4-12

Flow rates: Marprene TL, Bioprene TL (USGPM)

	mm	12	17
		LoadSure	LoadSure
	7-78	0.06-0.6	0.09-1.0
	8-76	0.07-0.6	0.10-0.9
	8-77	0.07-0.6	0.10-1.0
	8-83	0.07-0.7	0.10-1.0
	15-146	0.06-0.6	0.09-1.0
	17-83	0.14-0.7	0.21-1.0
	26-261	0.22-2.2	0.32-3.2
	47-237	0.39-2.0	0.58-2.9
	50-251	0.42-2.1	0.62-3.1
	52-259	0.43-2.2	0.65-3.2

Flow rates: Silicone (l/min)



	mm	12	17
		LoadSure	LoadSure
	7-78	0.23-2.6	0.30-3.3
	8-76	0.26-2.5	0.34-3.2
	8-77	0.26-2.5	0.34-3.3
	8-83	0.26-2.7	0.34-3.5
	15-146	0.49-4.8	0.64-6.2
	17-83	0.56-2.7	0.72-3.5
	26-261	0.86-8.6	1.1-11
	47-237	1.5-7.8	2.0-10

50-251	1.6-8.3	2.1-11
52-259	1.7-8.5	2.2-11



Flow rates: Silicone (USGPM)

	mm	12	17
		LoadSure	LoadSure
	7-78	0.06-0.7	0.08-0.9
	8-76	0.07-0.7	0.09-0.9
	8-77	0.07-0.7	0.09-0.9
	8-83	0.07-0.7	0.09-0.9
	15-146	0.13-1.3	0.17-1.6
	17-83	0.15-0.7	0.19-0.9
	26-261	0.23-2.3	0.29-2.9
	47-237	0.41-2.1	0.53-2.7
	50-251	0.43-2.2	0.56-2.8
	52-259	0.45-2.3	0.59-2.9

Flow rates: Neoprene, STA-PURE (l/min)

	mm	12	17
		LoadSure	LoadSure
	7-78	0.24-2.6	0.35-3.9
	8-76	0.27-2.6	0.40-3.8
	8-77	0.27-2.6	0.40-3.9
	8-83	0.27-2.8	0.40-4.2
	15-146	0.51-4.9	0.76-7.4
	17-83	0.57-2.8	0.86-4.2
	26-261	0.88-8.8	1.3-13
	47-237	1.6-8.0	2.4-12
	50-251	1.7-8.5	2.5-13
	52-259	1.8-8.8	2.6-13

Flow rates: Neoprene, STA-PURE (USGPM)

	mm	12	17
		LoadSure	LoadSure
	7-78	0.06-0.7	0.09-1.0
	8-76	0.07-0.7	0.11-1.0
	8-77	0.07-0.7	0.11-1.0
	8-83	0.07-0.7	0.11-1.1
	15-146	0.13-1.3	0.20-1.9
	17-83	0.15-0.7	0.23-1.1
	26-261	0.23-2.3	0.35-3.5
	47-237	0.42-2.1	0.63-3.2

50-251	0.45-2.2	0.67-3.3
52-259	0.46-2.3	0.69-3.5

28 Motor wiring for three-phase motors

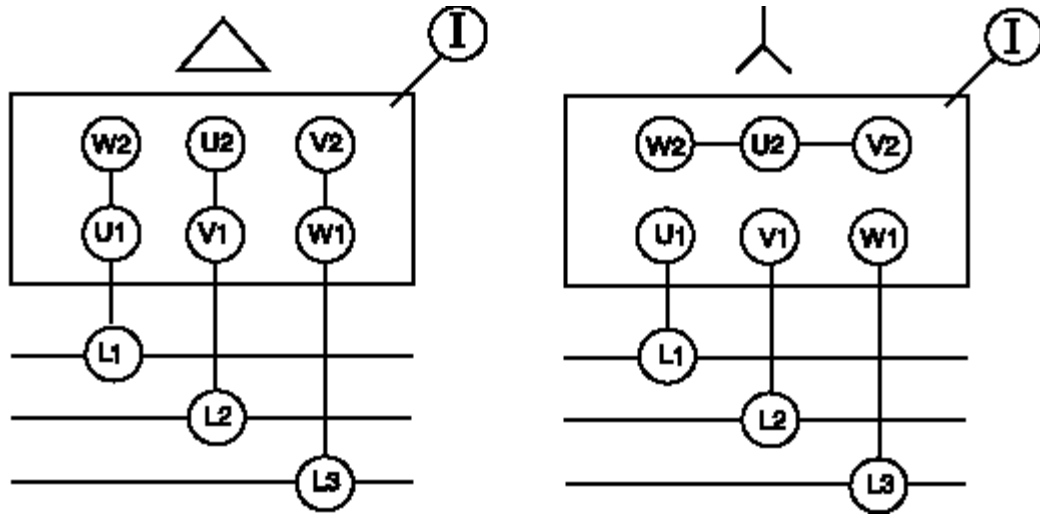

29 Dimensions in mm

621F/R

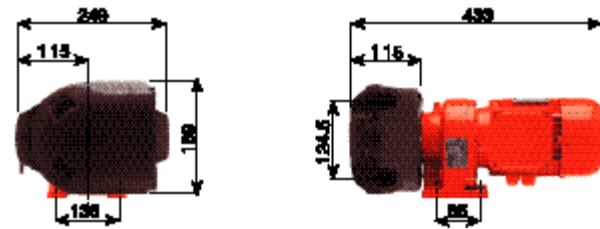

621T/R

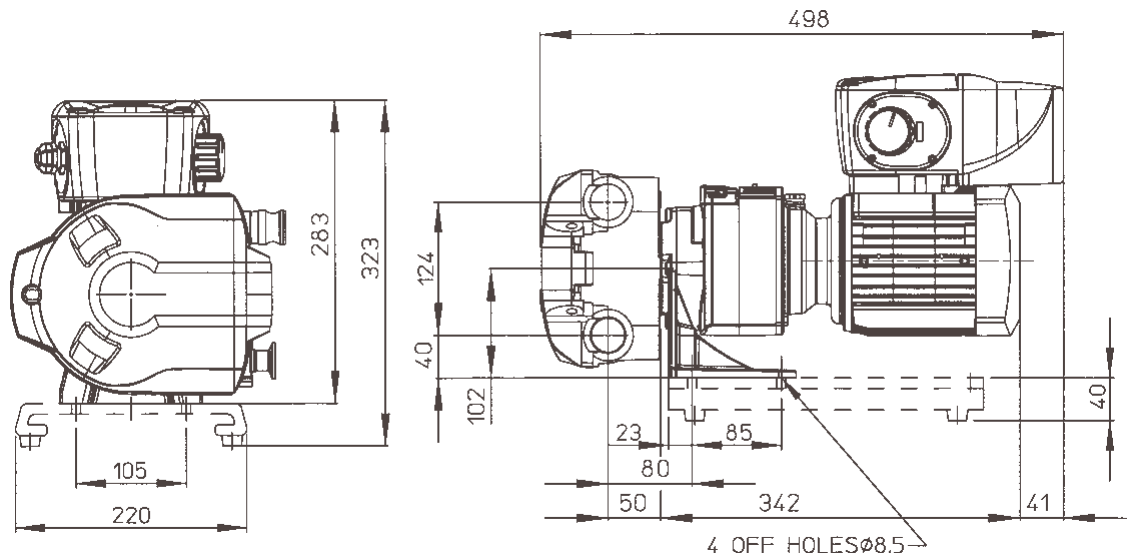

621FX/R

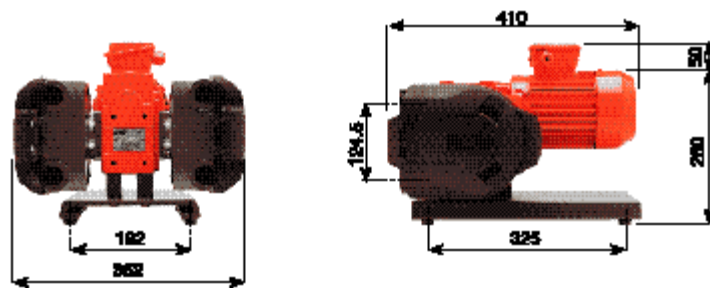

621P/R

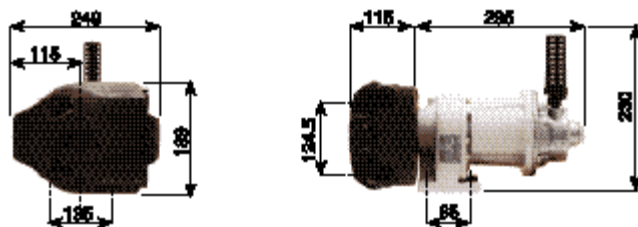

Switch

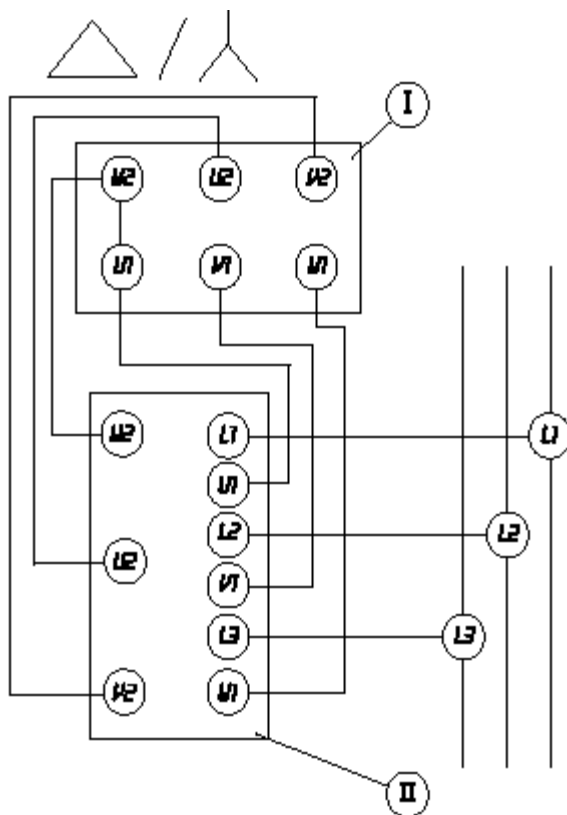

30 620R product codes

mm	inch	#	Marpene	Bioprene	Peroxide silicone	Platinum silicone
6.4	1/4	26	902.0064.032	903.0064.032	910.0064.032	913.0064.032
9.6	3/8	73	902.0096.032	903.0096.032	910.0096.032	913.0096.032
12.7	1/2	82	902.0127.032	903.0127.032	910.0127.032	913.0127.032
15.9	5/8	184	902.0159.032	903.0159.032	910.0159.032	913.0159.032

mm	inch	#	STA-PURE	Neoprene	Butyl	Tygon
6.4	1/4	26	960.0064.032	920.0064.032	930.0064.032	950.0064.032
9.6	3/8	73	960.0096.032	920.0096.032	930.0096.032	950.0096.032
12.7	1/2	82	960.0127.032	920.0127.032	930.0127.032	950.0127.032
15.9	5/8	184	960.0159.032	920.0159.032	930.0159.032	950.0159.032
mm	inch	#	Fluorel	Gore fluoroelastomer /PTFE		
6.4	1/4	26	970.0064.032	965.0064.032		
9.6	3/8	73	970.0096.032	965.0096.032		
12.7	1/2	82	970.0127.032	965.0127.032		
15.9	5/8	184	970.0159.032	965.0159.032		

31 620RE and 620RE4 LoadSure product codes

	12mm Tri-clamp 3/4in	17mm Tri-clamp 3/4in
STA-PURE	960.0120.PFT	960.0170.PFT
Gore fluoroelastomer /PTFE	965.0120.PFT	965.0170.PFT
Bioprene TM	903.P120.PFT	903.P170.PFT
Bioprene	903.0120.PFT	903.0170.PFT
Platinum silicone	913.0120.PFT	913.0170.PFT
	12mm Cam and Groove 3/4in	17mm Cam and Groove 3/4in
Marprene TM	902.P120.PPC	902.P170.PPC
Marprene	902.0120.PPC	902.0170.PPC
Peroxide silicone	910.0120.PPC	910.0170.PPC
Neoprene	920.0120.PPC	920.0170.PPC

32 Trademarks and disclaimer

Watson-Marlow, Loadsure, Bioprene and Marprene are trademarks of Watson-Marlow Limited.

TYGON is a trademark of the Saint Gobain Performance Plastics Company.

STA-PURE is a trademark of W L Gore and Associates.

The information contained in this document is believed to be correct but Watson-Marlow Limited accepts no liability for any errors it contains, and reserves the right to alter specifications without notice.

33 Patient-connected use: warning

Warning, These products are not designed for use in, and should not be used for patient connected applications.

34 Publication history

m-621cc-gb-01.htm: Watson-Marlow 621CC.
First electronically published 11 02.

m-621cc-gb-02.htm: Watson-Marlow 621CC.
First electronically published 12 04. Revised 06 06.

35 Decontamination certificate

In compliance with the *UK Health and Safety at Work Act* and the *Control of Substances Hazardous to Health Regulations*, you are required to declare the substances which have been in contact with product(s) you return to Watson-Marlow or its subsidiaries or distributors. Failure to do so will cause delays. Please ensure that you fax us this form and receive an RGA (Returned Goods Authorisation) before you despatch the product(s). A copy of this form must be attached to the outside of the packaging containing the product(s). Please complete a separate decontamination certificate for each product.

You are responsible for cleaning and decontaminating the product(s) before return.

Your name **Company**

Address

Postcode/zip **Country**

Telephone **Fax**

Product type **Serial number**

To speed the repair, please describe all known faults

The product has ... Been used Not been used

If the product has been used, please complete all the following sections. If the product has not been used, please just sign this form.

Names of chemicals handled with product(s)

Precautions to be taken in handling these chemicals

Action to be taken in the event of human contact

I understand that the personal data collected will be kept confidentially in accordance with the UK Data Protection Act 1998.

Signature

RGA number

Your position

Date

Please print out, sign and fax to Watson-Marlow Pumps at +44 1326 376009.

