

General Lab Products EU



# Natural Winners

You give your all to scientific research every day  
Eppendorf liquid handling instruments help you grow beyond your limits



# »Global Research, Eppendorf Engineering.«

Perfection down to the smallest detail – this principle is adhered to in the design and functionality of Eppendorf pipettes, dispensers and laboratory consumables. The Eppendorf competence and expertise in liquid handling has resulted in many innovations, award-winning ergonomic designs, cutting edge production and the selection of optimal materials for our products.

## The Eppendorf Liquid Handling Instrument Portfolio

As the first company to launch a microliter pipette, we at Eppendorf have over 60 years' experience in precise manual and automatic pipetting & dispensing to transfer even the smallest quantities of liquids. Today, liquid handling systems from Eppendorf are used wherever accuracy, precision, and absolute reliability are important. In our product development, we strive to simplify cumbersome lab work and make it as safe and efficient as possible so you can concentrate on and accelerate your research.

### Master Your Challenging Liquids!

Are you working with viscous, volatile, dense or foaming liquids? Become an expert and master even challenging liquids precisely with the right tool.



> See page 10 for more information

### Eppendorf PhysioCare Concept®

The use of our liquid handling products has been proven to reduce physical and psychological strain to a minimum by following the rules of the PhysioCare Concept.



> See page 34 for more information

### Eppendorf Services

A comprehensive range of service programs including maintenance, seminars, application, and technical support as well as certification services build the basis for premium support.

**epServices**  
for premium performance

> See page 35 for more information

# A History of Quality and Innovation

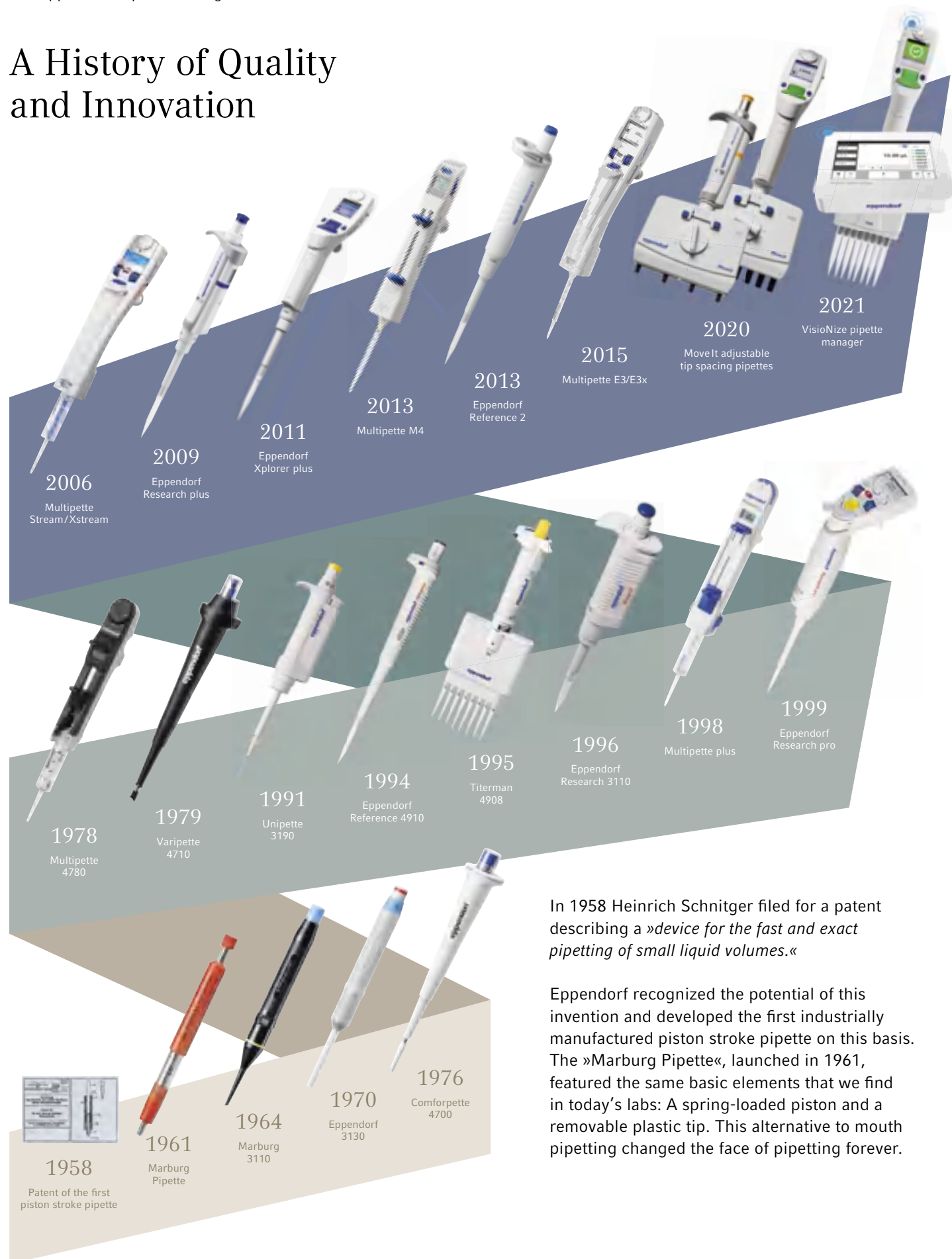

In 1958 Heinrich Schnitger filed for a patent describing a »device for the fast and exact pipetting of small liquid volumes.«

Eppendorf recognized the potential of this invention and developed the first industrially manufactured piston stroke pipette on this basis. The »Marburg Pipette«, launched in 1961, featured the same basic elements that we find in today's labs: A spring-loaded piston and a removable plastic tip. This alternative to mouth pipetting changed the face of pipetting forever.

## Which Instrument Should you Use?

Selecting the right pipette or dispenser can be the key to success in your work. It can boost your efficiency and throughput and ensure reliable results for different use cases.

Should you be new to liquid handling, please refer to the information below for a quick introduction to the basics.

### What are air-cushion and positive displacement instruments?

#### Air-cushion principle

Air-cushion pipettes are most commonly used in labs around the world and ideal for liquids with physical properties similar to water. In this instrument type, the piston is separated from the liquid sample by a small air cushion. Temperature or humidity changes, as well as the physical properties of different liquids can affect the performance of air-cushion instruments. To reduce these risks however, Eppendorf air-cushion pipettes work with extra small air cushions and may be temporarily adjusted to different liquids.

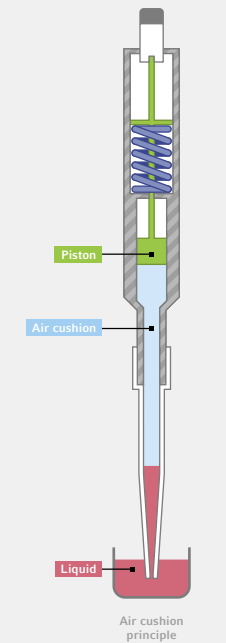

#### Positive displacement principle

In positive displacement systems, the piston is part of the tip and in direct contact with the liquid. There is no air cushion that may be affected by liquid sample properties. These tools are therefore ideal for liquids with varying viscosity, volatility, surface tension or density as well as hot or cold liquids. The disposable tips with integrated pistons also prevent contamination and help to keep user and instrument safe when working with hazardous liquids.

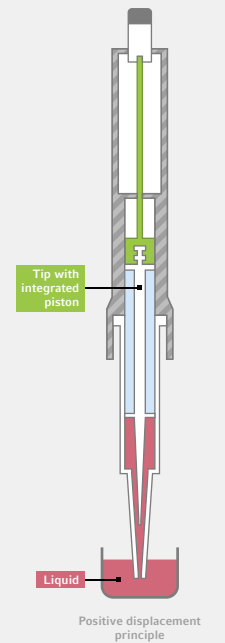

### When should you use an electronic instrument?

The most important general benefits of using an electronic instrument are: better ergonomics by requiring almost no operating forces, a higher precision and reproducibility and an additional efficiency gain due to various operating modes (such as e.g. pipetting and dispensing with only one tool). Furthermore, electronic instruments are the basis for digital lab solutions supporting scientists with choosing settings for different liquid types, collaborating across the lab or documenting steps.



### When should you think about an automated solution?







Automated liquid handling systems such as the epMotion® family are ideal to take over routine and repetitive pipetting tasks that are commonly found in many molecular biological applications. They are ideally suited whenever complex processes need to be standardized, help to reduce the risk of manual pipetting errors, increase reproducibility and free up your valuable time for other tasks.









# Selection Guide

## Air-cushion principle

						
<b>Model</b>	<b>Eppendorf Research® plus</b>	<b>Eppendorf Reference® 2</b>	<b>Eppendorf Xplorer®/Xplorer® plus</b>	<b>Eppendorf Research® plus Move It® Eppendorf Xplorer® plus Move It®</b>	<b>Easypet® 3</b>	<b>Pipet Helper®</b>
<b>Application</b>	Pipetting of aqueous liquids	Pipetting of aqueous liquids	Pipetting of aqueous liquids	Pipetting of aqueous liquids	Pipetting of aqueous liquids with serological and volumetric pipettes	Pipetting of aqueous liquids with serological and volumetric pipettes
<b>Product type</b>	Pipette	Pipette	Pipette	Pipette	Pipette controller	Pipette controller
<b>Compatible with VisioNize® pipette manager</b>	–	–	Yes	Yes (Xplorer plus variants only)	–	–
<b>Operation</b>	Mechanical, separate control button and ejector	Mechanical, combined control button and ejector	Electronic, separate control button and ejector	Mechanical or electronic, separate control button and ejector	Electronic	Mechanical
<b>Pipetting type</b>	Air-cushion	Air-cushion	Air-cushion	Air-cushion	Air-cushion	Air-cushion
<b>Adjustable cone spacing</b>	No	No	No	Yes	No	No
<b>Positioning</b>	Ultra light weight and pipetting force for ultimate ergonomics	Reliability in robustness and results	Intuitive and fast pipetting	Double your performance when transferring multiple samples between changing formats	Overall ergonomic concept with new speed control for stress-free pipetting	A perfect instrument for inexperienced users because of its robust and intuitive design
<b>Volume range</b>	0.1 µL–10 mL	0.1 µL–10 mL	0.5 µL–10 mL	1–1,200 µL	0.1–100 mL	0.1–100 mL
<b>Available options</b>	1-channel 8-channel 12-channel 16-channel 24-channel	1-channel 8-channel 12-channel	1-channel 8-channel 12-channel 16-channel 24-channel	4-channel (9-33 mm) 6-channel (9-20 mm) 8-channel (9-14 mm) 8-channel (4.5-14 mm) 12-channel (4.5-9 mm)	1-channel	1-channel
<b>Autoclavable</b>	Yes	Yes	Yes (lower part)	Yes (Xplorer plus only lower part)	Yes (pipette adapter and aspirating cone)	Yes
<b>Consumables</b>	epT.I.P.S.® and ep Dualfilter T.I.P.S.® as well as other pipette tip brands	epT.I.P.S.® and ep Dualfilter T.I.P.S.® as well as other pipette tip brands	epT.I.P.S.® and ep Dualfilter T.I.P.S.® as well as other pipette tip brands	epT.I.P.S.® and ep Dualfilter T.I.P.S.® as well as other pipette tip brands	Eppendorf Serological Pipets and other volumetric and serological pipettes	Eppendorf Serological Pipets and other volumetric and serological pipettes
<b>Purity grades of consumables</b>	> Eppendorf Quality™ > PCR clean & sterile > Eppendorf Biopur® > Forensic DNA Grade	> Eppendorf Quality™ > PCR clean & sterile > Eppendorf Biopur® > Forensic DNA Grade	> Eppendorf Quality™ > PCR clean & sterile > Eppendorf Biopur® > Forensic DNA Grade	> Eppendorf Quality™ > PCR clean & sterile > Eppendorf Biopur® > Forensic DNA Grade	> Sterile > Free of detectable RNase & DNase > Free of detectable pyrogens > Free of detectable DNA > Forensic DNA Grade	> Sterile > Free of detectable RNase & DNase > Free of detectable pyrogens > Free of detectable DNA > Forensic DNA Grade
<b>Page</b>	12	14	16	18	26	26

\*\* Combitips advanced only





## Positive displacement principle

					
<b>Model</b>	<b>Multipette® M4</b>	<b>Multipette® E3/E3x</b>	<b>Varipette® 4720</b>	<b>Varispenser® 2/2x</b>	<b>Eppendorf Top Buret™</b>
<b>Application</b>	Dispensing of up to 100 steps per Combitip filling of aqueous, viscous and volatile liquids	Dispensing of up to 100 steps per Combitip filling of aqueous, viscous and volatile liquids	Contamination-free pipetting of aqueous, viscous and volatile liquids	Single stroke dispensing of lyes, acids, bases, aqueous liquids or solvents	Titration of aqueous liquids
<b>Product type</b>	Dispenser	Dispenser	Pipette	Bottletop dispenser	Bottletop burette
<b>Compatible with VisioNize® pipette manager</b>	–	–	–	–	–
<b>Operation</b>	Mechanical	Electronic	Mechanical	Mechanical	Electronic
<b>Pipetting type</b>	Positive displacement	Positive displacement	Positive displacement and air-cushion	Positive displacement	Positive displacement
<b>Adjustable cone spacing</b>	No	No	No	No	No
<b>Positioning</b>	Time savings for serial dispensing and high accuracy for challenging liquids	Reduced strain for long dispensing series and highest volume flexibility	Pipetting with reduced outside fault effects	Safe and easy dispensing of liquid from supply and reagent bottles	Continuous and pulse-free titration
<b>Volume range</b>	1 µL–10 mL	1 µL–50 mL	1–10 mL	0.2–100 mL	0.1–999.9 mL
<b>Available options</b>	1-channel	1-channel	1-channel	1-channel	1-channel
<b>Autoclavable</b>	No	No	No	Yes	No
<b>Consumables</b>	Combitips advanced® ViscoTip®	Combitips advanced® ViscoTip®	Eppendorf Varitips	–	–
<b>Purity grades of consumables</b>	> Eppendorf Quality™ > PCR clean** > Eppendorf Biopur®** > Forensic DNA Grade**	> Eppendorf Quality™ > PCR clean** > Eppendorf Biopur®** > Forensic DNA Grade**	> Eppendorf Quality™	–	–
<b>Page</b>	22	23	27	27	27

\*\* Combitips advanced only







**When should I use positive displacement instruments?**  
Positive displacement instruments are ideal for liquids with physical properties other than those of water. These include liquids with varying viscosity, volatility, surface tension or density as well as hot, cold or hazardous liquids.

## Automated liquid handling

				
<b>Model</b>	<b>epMotion® 96 and epMotion® 96xl</b>	<b>epMotion® 5070</b>	<b>epMotion® 5073</b>	<b>epMotion® 5075</b>
<b>Application</b>	Pipetting of aqueous liquids with 96 channels at once	Serial pipetting of aqueous, viscous and volatile liquids in automated way for easy tasks on small foot print	Serial pipetting of aqueous, viscous and volatile liquids in automated way for routine tasks	Serial pipetting of aqueous, viscous and volatile liquids in automated way with highest flexibility and tool options
<b>Product type</b>	Semi-automated 96 channel pipette	Automated Liquid Handling	Automated Liquid Handling	Automated Liquid Handling
<b>Compatible with VisioNize® pipette manager</b>	–	–	–	–
<b>Operation</b>	Electronic	Automation	Automation	Automation
<b>Pipetting type</b>	Air-cushion	Air-cushion	Air-cushion	Air-cushion
<b>Adjustable cone spacing</b>	No	No	No	No
<b>Positioning</b>	Intuitive and fast pipetting in 96 and 384 format	Reproducible, contamination-free, contactless pipetting at high precision and accuracy	Same as 5070 but more flexibility with 6 deck positions and more features	Same as 5070 but full flexibility with 15 deck positions and even more features
<b>Volume range</b>	epMotion 96: 0.5–300 µL, epMotion 96xl: 5–1,000 µL	0.2–1,000 µL, 1 & 8 channel	0.2–1,000 µL, 1 & 8 channel	0.2–1,000 µL, 1 & 8 channel
<b>Available options</b>	2-position lifting table	Automatic exchange of 2 dispensing tools, PC control	Same as 5070, plus gripper transport, 1 thermal module, ThermoMixer, HEPA filter & UV light, automatic exchange of 3 dispensing tools	Same as 5073, plus up to 3 thermal modules, automatic exchange of 4 dispensing tools, ThermoMixer and/or vacuum manifold
<b>Autoclavable</b>	No	Yes (tools)	Yes (tools), UV light and HEPA filter (optional)	Yes (tools), UV light and HEPA filter (optional)
<b>Consumables</b>	epT.I.P.S.® Motion reload system	epT.I.P.S.® Motion tips as racks or reloads	epT.I.P.S.® Motion tips as racks or reloads	epT.I.P.S.® Motion tips as racks or reloads
<b>Purity grades of consumables</b>	> Eppendorf Quality™ > PCR clean > PCR clean & sterile	> Eppendorf Quality™ > PCR clean > PCR clean & sterile	> Eppendorf Quality™ > PCR clean > PCR clean & sterile	> Eppendorf Quality™ > PCR clean > PCR clean & sterile
<b>Page</b>	30	31	32	33

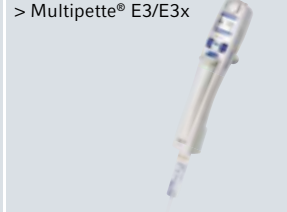
**Automated liquid handling**  
Easy programming of liquid handling steps for aspiration, dispensing or multi-dispensing of defined liquid classes, temperature incubations, plate-mixing, vacuum, or magnetic bead separations.

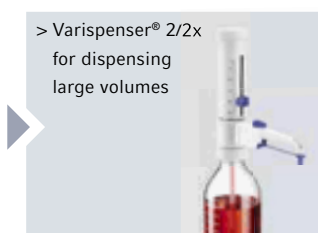
# Master Any Type of Liquid

Type of Liquid		Water	Viscous e.g. glycerol, oil	Dense e.g. sulfuric acid, caesium chloride	Volatile e.g. acetone, ethanol	Infectious / radioactive e.g. biohazard material	Detergent / detergent-containing e.g. Tween 20, Triton™ X-100	Foaming e.g. protein-containing liquids	Eppendorf Solutions	
									Mechanical systems	Electronic systems
Potential problems	Observations	<ul style="list-style-type: none"> <li>&gt; Air-cushion pipettes are optimized to the physical properties of water</li> </ul>	<ul style="list-style-type: none"> <li>&gt; High resistance to flow</li> <li>&gt; Liquid residues stay attached to inside tip wall</li> <li>&gt; Imprecise results</li> </ul>	<ul style="list-style-type: none"> <li>&gt; Influence on size of air-cushion</li> <li>&gt; Dispensed volume too low or too high</li> </ul>	<ul style="list-style-type: none"> <li>&gt; Air-cushion expands</li> <li>&gt; Liquid drips out of the tip</li> <li>&gt; Imprecise results</li> </ul>	<ul style="list-style-type: none"> <li>&gt; Aerosols contaminate pipette</li> <li>&gt; Threat to human health and sample safety</li> </ul>	<ul style="list-style-type: none"> <li>&gt; Reduced surface tension</li> <li>&gt; Liquid residues stick to the inner wall of the tip</li> <li>&gt; Imprecise results</li> </ul>	<ul style="list-style-type: none"> <li>&gt; Foam is created</li> <li>&gt; Liquid residues remain in the tip</li> <li>&gt; Imprecise results</li> </ul>	<b>Advantages</b> <ul style="list-style-type: none"> <li>&gt; Easy to clean</li> <li>&gt; Economical</li> <li>&gt; Lightweight</li> </ul>	<b>Advantages</b> <ul style="list-style-type: none"> <li>&gt; High reproducibility</li> <li>&gt; Ergonomic working</li> <li>&gt; Multifunctionality</li> </ul>
	Workaround	<ul style="list-style-type: none"> <li>&gt; Optimally suitable for the use of water</li> <li>&gt; No adaptation necessary</li> </ul>	<ul style="list-style-type: none"> <li>&gt; Work slowly</li> <li>&gt; Reverse pipetting</li> <li>&gt; Adjust to liquid type*1</li> </ul>	<ul style="list-style-type: none"> <li>&gt; Adjust pipette to liquid density</li> <li>&gt; Adjust to liquid type*1</li> </ul>	<ul style="list-style-type: none"> <li>&gt; Prewet at least 5 times</li> <li>&gt; Reverse pipetting</li> <li>&gt; Adjust to liquid type*1</li> </ul>	<ul style="list-style-type: none"> <li>&gt; Use filter tips</li> <li>&gt; Automated systems protect user and sample</li> </ul>	<ul style="list-style-type: none"> <li>&gt; Use tips with low retention effect</li> <li>&gt; Adjust to liquid type*1</li> </ul>	<ul style="list-style-type: none"> <li>&gt; Reverse pipetting</li> </ul>	<ul style="list-style-type: none"> <li>&gt; Eppendorf Research® plus</li> <li>&gt; Eppendorf Reference® 2</li> <li>&gt; Research plus Move It®</li> <li>&gt; Pipet Helper®</li> </ul> 	<ul style="list-style-type: none"> <li>&gt; Eppendorf Xplorer® (plus)</li> <li>&gt; VisioNize® pipette manager</li> <li>&gt; Xplorer plus Move It®</li> <li>&gt; Easypet® 3</li> <li>&gt; epMotion®</li> </ul> 
Recommendations	Positive displacement dispenser	<ul style="list-style-type: none"> <li>&gt; Serial pipetting for multiple samples and vessel formats</li> </ul>	<ul style="list-style-type: none"> <li>&gt; Higher precision regardless of physical properties of liquid</li> <li>&gt; Serial dispensing</li> <li>&gt; No adjustment to liquid type needed</li> </ul>	<ul style="list-style-type: none"> <li>&gt; Higher precision regardless of physical properties of liquid</li> <li>&gt; Serial dispensing</li> <li>&gt; No adjustment to liquid type needed</li> </ul>	<ul style="list-style-type: none"> <li>&gt; Higher precision regardless of physical properties of liquid</li> <li>&gt; Serial dispensing</li> <li>&gt; No adjustment to liquid type needed</li> </ul>	<ul style="list-style-type: none"> <li>&gt; Higher precision regardless of physical properties of liquid</li> <li>&gt; Serial dispensing</li> </ul>	<ul style="list-style-type: none"> <li>&gt; Higher precision regardless of physical properties of liquid</li> <li>&gt; Serial dispensing</li> </ul>	<ul style="list-style-type: none"> <li>&gt; Higher precision regardless of physical properties of liquid</li> <li>&gt; Serial dispensing</li> </ul>	<ul style="list-style-type: none"> <li>&gt; Multipette® M4</li> </ul> 	<ul style="list-style-type: none"> <li>&gt; Multipette® E3/E3x</li> </ul> 
	Positive displacement pipettes	<ul style="list-style-type: none"> <li>&gt; Varitip S*3,4 system allows accurate pipetting from large bottles and narrow vessels</li> </ul>	<ul style="list-style-type: none"> <li>&gt; Varitip P*2 allows accurate pipetting, for example from beakers</li> </ul>	<ul style="list-style-type: none"> <li>&gt; Varitip P*2 allows accurate pipetting, for example from beakers</li> </ul>	<ul style="list-style-type: none"> <li>&gt; Varitip P*2 allows accurate pipetting, for example from beakers</li> <li>&gt; Varitip S system and valve for drip-free dispensing</li> </ul>	<ul style="list-style-type: none"> <li>&gt; Varitip P*2 allows accurate pipetting, for example from beakers</li> </ul>	<ul style="list-style-type: none"> <li>&gt; Varitip P*2 allows accurate pipetting, for example from beakers</li> </ul>	<ul style="list-style-type: none"> <li>&gt; Varitip P*2 allows accurate pipetting, for example from beakers</li> </ul>	<ul style="list-style-type: none"> <li>&gt; Varipette® 4720</li> </ul> 	
	Bottletop dispenser and burets	<ul style="list-style-type: none"> <li>&gt; Liquid dispensing directly from supply bottles</li> </ul>	<ul style="list-style-type: none"> <li>&gt; Liquid dispensing directly from supply bottles (with Varispenser® 2/2x up to a viscosity of 500 mm<sup>2/s</sup>)</li> </ul>	<ul style="list-style-type: none"> <li>&gt; Liquid dispensing directly from supply bottles up to a density of 2.2 g/cm<sup>3</sup></li> </ul>	<ul style="list-style-type: none"> <li>&gt; Liquid dispensing directly from supply bottles up to a vapor pressure of 500 mbar</li> </ul>	<ul style="list-style-type: none"> <li>&gt; Liquid dispensing directly from supply bottles</li> </ul>	<ul style="list-style-type: none"> <li>&gt; Liquid dispensing directly from supply bottles (with Varispenser® 2/2x up to a viscosity of 500 mm<sup>2/s</sup>)</li> </ul>	<ul style="list-style-type: none"> <li>&gt; Liquid dispensing directly from supply bottles</li> </ul>	<ul style="list-style-type: none"> <li>&gt; Varispenser® 2/2x for dispensing large volumes</li> </ul> 	<ul style="list-style-type: none"> <li>&gt; Eppendorf Top Buret™ for titration</li> </ul> 

\*1 This option is only available on automated systems and electronic pipettes  
 \*2,3,4 See Varipette® 4720 for corresponding Eppendorf Varitips®

## Eppendorf Research® plus

The Eppendorf Research plus combines about 60 years of innovation in liquid handling to provide you with one of the safest and most ergonomic pipettes available today. The Research plus pipette is remarkably light, both in terms of weight and pipetting forces, setting new standards for ergonomic operation. It is comforting to know you are working with one of the most advanced pipettes in the world.

A spring loaded tip cone, a temporary adjustment option, an improved volume display – and all that in an ultra light, fully autoclavable pipette. The Research plus pipette will become an indispensable tool in your laboratory.



reddot design award  
winner 2009



### Research plus benefits

- > Ultra light mechanical pipette designed according to the strict criteria of the Eppendorf PhysioCare Concept®
- > Very low weight and operating forces for advanced ergonomics to limit strain on your hand and arm
- > Temporary adjustment option to offset inaccuracies when pipetting warm, cold, volatile or high density liquids and return to factory adjustment without calibration
- > One of the most commonly used pipettes in the world
- > Available as single-, 8-, 12-, 16- and 24-channel as well as adjustable tip spacing multi-channel pipette (Move It®)

### Advanced ergonomics

Feel the difference in weight, pipetting forces and the spring loaded tip cone\*.

### Low tip attachment force

Achieve optimal tightness and minimal attachment forces with the Eppendorf Research plus pipette. The spring loaded tip cone\* helps to reduce stress without sacrificing tightness.

### Low tip ejection force

How many tips do you use per day? Even small differences in the tip ejection force make a big change if you do it day by day. With the Eppendorf Research plus pipette, you'll benefit from one of the lowest tip ejection forces on the market.

### High flexibility

Your new pipette should offer all the flexibility you need. Adjust your Research plus to your needs, autoclave the entire pipette or only the lower part. Choose among single-channel, multi-channel and fixed-volume pipettes in different sizes.

### Temporary adjustment option for various liquid classes

Adjust your pipette in seconds for better accuracy when pipetting various difficult liquids like ethanol or even when pipetting at high altitudes.

### Spring-loaded tip cone\* for exactly reproducible tip fit

No need for rocking. Just a soft pressure is sufficient for tip attachment. Get extremely consistent sample pickup, even in multi-channel pipettes, and maximize user to user reproducibility for more uniform results in your lab.

\* Not available in all variants.

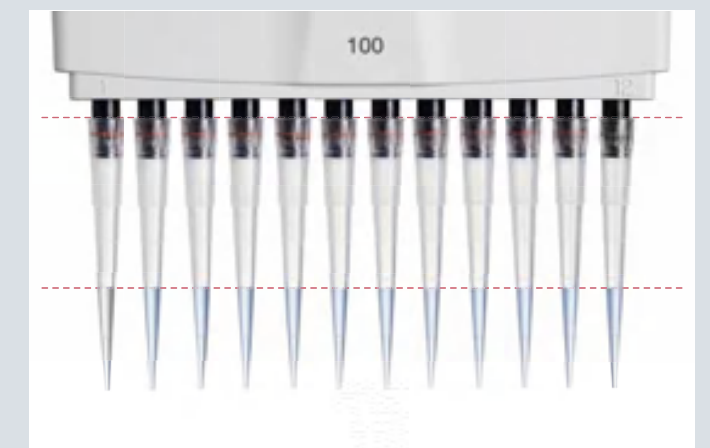

> Learn more about  
Eppendorf 16- & 24-channel pipettes at  
[www.eppendorf.com/ready-set-pipette](http://www.eppendorf.com/ready-set-pipette)



## Eppendorf Reference® 2

The name »Reference« stands for extraordinary precision and accuracy, a long service life, and an ergonomic design. With an innovative one-button operation, the Reference 2 allows fast and ergonomic handling with reduced operating efforts. Its unique smooth surface and autoclavability guarantee efficient decontamination making it the ideal companion when working under sterile conditions.

Our best material and the latest technologies are implemented in this pipette, making it a reliable partner for you and your demanding work.

### Reference 2 benefits

- > High precision and accuracy provides reliable results
- > 4-digit display for highly accurate volume setting (clearly visible from every angle)
- > Quick and secure volume setting, including volume lock
- > Fully autoclavable and easy-to-clean smooth surface
- > Color coded and volume labeling for quick identification of the volume size/tip size
- > Round upper part makes it possible to work in every position
- > Available as a single-channel pipette in fixed or variable volume as well as 8- and 12-channel pipette

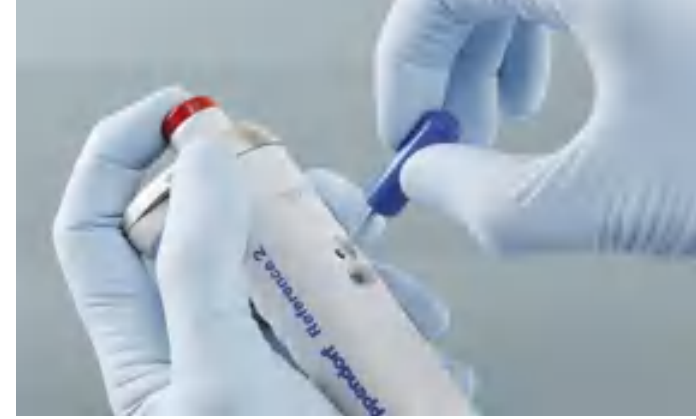

### User friendly temporary adjustment

For liquids other than aqueous solutions, pipettes have to be adjusted. The Reference 2 provides easy possibility to do so, leaving the factory settings untouched. Reset back to manufacturer setting just as quick and easy.

### Stainless steel upper part

The external edges made from stainless steel equip the Reference 2 with outstanding robustness at potential impact sites. It includes a quick volume setting and secure volume lock.



### Spring-loaded tip cone

Attach every tip with the same force – regardless of the user. Achieve optimal tightness with low attachment and ejection forces.

### Unique surface

Few grip marks and a smooth surface for comfortable working and simple cleaning. The Reference 2 is fully autoclavable without disassembling.

### Sturdy upper handle

Guarantees long service life and increased robustness.

### Heightened traceability

The serial number is printed on multiple components of the pipette. This prevents parts from being mixed up and indicates if one of the volume defining parts has been exchanged.

# Eppendorf Xplorer®/Eppendorf Xplorer® plus

People who give 100% every day deserve the best tools and the best equipment. You work on demanding problems, and important decisions depend on the results of your work. With the Eppendorf Xplorer or Xplorer plus electronic pipette, your work achieves a new level of simplicity, precision and reproducibility, which means no more delays due to complicated programming or inflexible processes.

### Xplorer/Xplorer plus benefits

- > Intuitive handling: Selection dial & multifunctional rocker
- > Optimal ergonomics: Designed according to Eppendorf PhysioCare Concept
- > High reproducibility: Spring loaded tip cone, individual adjustment, and a motorized piston
- > Ease of use: After tip ejection, the piston automatically returns to the zero position
- > Includes a history function that automatically saves the last parameters for faster handling
- > Full control: Edit and Help at the push of a button
- > Available as single-, 8-, 12-, 16-, and 24-channel as well as adjustable tip spacing multi-channel pipette (Move It®)

### Expanded version

The Eppendorf Xplorer plus electronic pipette is the perfect choice for all users who simply need a little extra – more safety and speed every day! With its additional intelligent modes, adjustable fixed volumes and individual settings, tasks are performed much faster and easier. A password can be entered to guarantee the highest degree of protection for your programming and settings.

To ensure adherence to service intervals and thus guarantee the accuracy of your results, the Xplorer plus pipette offers an integrated service reminder. You can choose a reminder based on the period of time or on the frequency of use.



reddot design award  
best of the best



### 16- and 24-channel pipettes

The Eppendorf Xplorer plus is available as single-, 8-, 12-, 16- and 24-channel pipette.



**VisioNize® pipette manager**  
Connect electronic pipettes and start pipetting right away. See more on page 28.

**Modern color display**  
All parameters without submenus

**Individual speed setting**  
Adjust speed to improve precision and accuracy

**Multifunctional rocker**  
With »up is up« and »down is down« functionality

**Selection dial**  
All functions at a glance and easily selectable

**Multilingual menu**  
User interface in 9 languages

**Function control softkeys**  
Edit and Help at the push of a button

**Innovative ejector**  
Electronically linked to the piston control



> Learn more about Eppendorf 16- & 24-channel pipettes at [www.eppendorf.com/ready-set-pipette](http://www.eppendorf.com/ready-set-pipette)



# Eppendorf Research® plus and Xplorer® plus Move It®

## Double your performance

Often, single-channel pipettes are used for multiple sample transfer from one vessel type to another, from tubes to plates for instance. This can be time-consuming and inconvenient, especially when throughput increases. Instead of pipetting many times, up to twelve samples can now be moved simultaneously with the 4-, 6-, 8- and 12-channel Move It pipettes. Move It pipettes are equipped with adjustable cones for variable tip spacings according to your vessel format. This easy handling of format changes helps to reduce throughput time by 50 % and increase reproducibility of your results.



**Format limiter**  
Enabling quick switches backwards and forwards between the formats



**Rotating lower part – 360°**  
> Comfortable readability of display  
> Ergonomic and relaxed body posture

**Adjustment knob**  
> Quick manual tip spacing adjustment  
> Spacing adjustment without vibrations

**Adjustable tip spacing**  
> For microplates, sample tubes, agarose gels and further formats  
> Tip spacing freely selectable between 4.5 and 33 mm

## Move It benefits

- > Easy and fast format changes increasing your efficiency up to 50 %
- > Less breaks needed thanks to an optimal balance in the hand
- > 360° rotatable pipette head for fast identification of parameters
- > Tubeless design allows for increased durability, precision and autoclavability

**Tubeless system**  
> Reliable robustness and precision  
> Easy autoclavability\*

**Format change**  
> Easy and fast among plates with up to 384 wells, 1.5 and 2.0 mL tubes and agarose gels

\* Xplorer plus lower part only, Research plus fully autoclavable

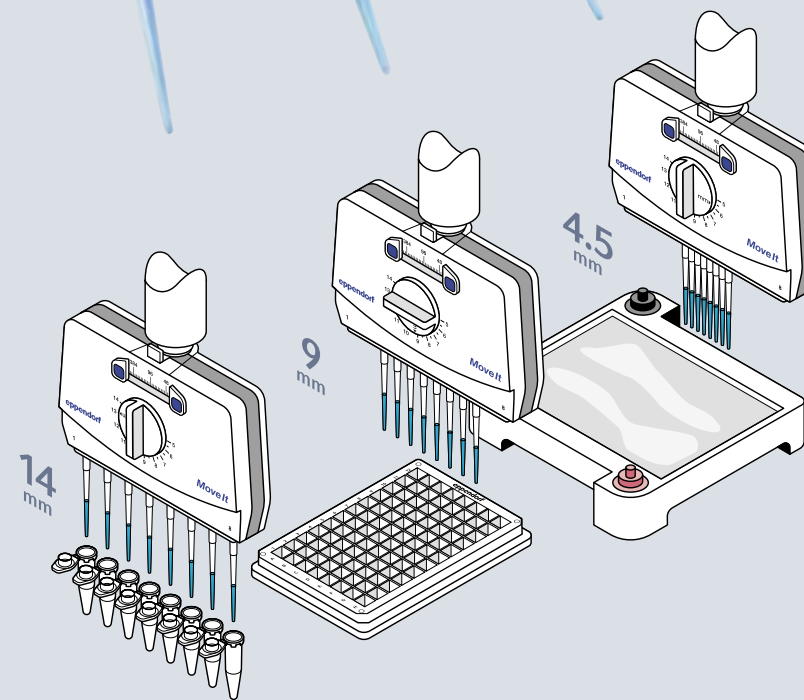

> Find more information on [www.eppendorf.com/move-it](http://www.eppendorf.com/move-it)



## epT.I.P.S.<sup>®</sup>

The fact that a tip fits onto a pipette cone does not say anything about the performance of the pipetting system comprising the components »Pipette and Tip«. The standard ISO 8655:2002 (1) considers pipettes and pipette tips as a system. Eppendorf as a system provider manufactures a system instead of single parts of it.

epT.I.P.S. pipette tips are available in purity grades of Eppendorf Quality, PCR clean and Biopur<sup>®</sup>. Packed as reloads, reusable boxes, racks for single-use and singles blistered in medical paper.



## ep Dualfilter T.I.P.S.<sup>®</sup>

Premium filter tips with a two-phase filter for contamination protection. The two filter layers, made of flexible, hydrophobic material, fit perfectly in the tip cone and retain practically 100 % of all aerosols and biomolecules.

ep Dualfilter T.I.P.S. are available in PCR clean/Sterile and Forensic DNA Grade. Also available as ep Dualfilter T.I.P.S. SealMax for reliable protection from accidental over-pipetting.

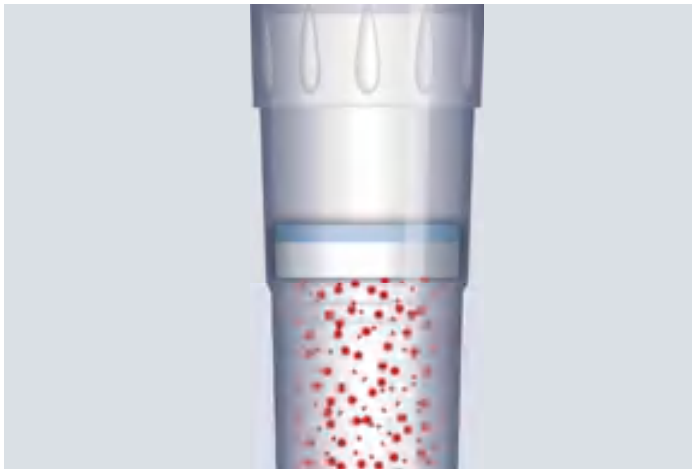

## epT.I.P.S.<sup>®</sup> 384

epT.I.P.S. 384 pipette tips are optimized for Eppendorf 16- and 24-channel pipettes and selected Move It variants. Process 384-well plates manually with highest level of tip tightness and coaxiality but extraordinary low operating forces.

epT.I.P.S. 384 are available in purity grades of Eppendorf Quality and PCR clean, packed as reusable box and reloads.

Also available: ep Dualfilter T.I.P.S. 384 with the renowned Eppendorf dualfilter technology.

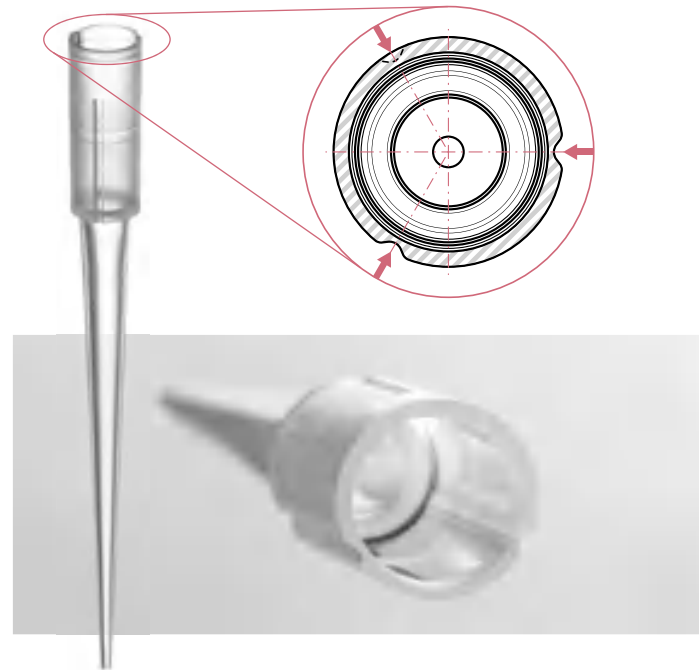

## Twice as Fast in 384-Well Applications

With the advent of the high-throughput screening approach, which is widely used in the pharmaceutical industry, the need for microplates with a larger number of wells arose.

The 384-well microplate was then developed and implemented as a consumable for drug development assays.

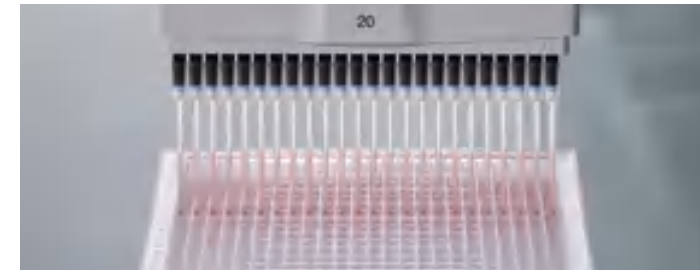

## 16 / 24-channel pipettes and epT.I.P.S.<sup>®</sup> 384

With the lightweight Research plus pipette or the fast and precise Xplorer plus electronic pipette you get a higher volume of precision work done. Get extremely consistent sample pickup across all channels and fill a complete 384-well plate within 1 minute. It couldn't be easier to perfectly hit all 384 wells as the epT.I.P.S. 384 have an extremely fine tip shape, and an extraordinary coaxiality which enables a perfect tip alignment.

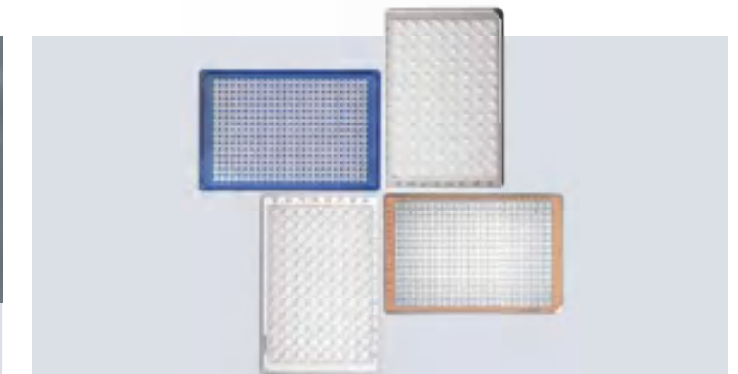

## 384-well Plates

Eppendorf consumables make everyday routines faster, easier, and more reliable. Eppendorf 384-well plates are available as Deepwell plates (384/200  $\mu$ L), Microplates (384/F and 384/V), Assay/Reader Microplates (384/V black and white), Protein and DNA LoBind and twin.tec<sup>®</sup> PCR plates.

[www.eppendorf.com/plates](http://www.eppendorf.com/plates)

## Also interesting

Eppendorf ThermoMixer<sup>®</sup> FP



[www.eppendorf.com/thermomixer](http://www.eppendorf.com/thermomixer)

Eppendorf Centrifugation



[www.eppendorf.com/centrifuges](http://www.eppendorf.com/centrifuges)

Mastercycler<sup>®</sup> X50h



[www.eppendorf.com/mastercycler](http://www.eppendorf.com/mastercycler)



> Read here how pipette tips influence results:  
Application Note #354 »The Tip of the Iceberg«

> Eppendorf workflow solutions: [www.eppendorf.com/workflows](http://www.eppendorf.com/workflows)





## Multipette® M4

The Multipette M4 multi-dispenser is the ideal precision instrument for completing long pipetting series without the need for repeated liquid aspiration.

The Multipette dispenser is the tool of choice when working with liquids that possess demanding physical properties like high viscosity, density or volatility. With the Multipette/Combitips® system, volumes are dispensed using the positive displacement principle. The liquid is directly dispensed without an air-cushion, ensuring highest precision regardless of the physical properties of the liquid.

### Multipette M4 benefits

- > Automatic Combitips® advanced dispenser tips recognition eliminates time-consuming volume calculations
- > Dispensing up to 100 times without refilling the Combitips® tip
- > Wide dispensing range: 1 µL to 10 mL
- > Stress-free work via integrated step counter: Dispensing procedures can be continued error-free after an interruption or distraction
- > Fully emptied Combitips® can be easily ejected with one hand using the operating lever



reddot design award winner 2013

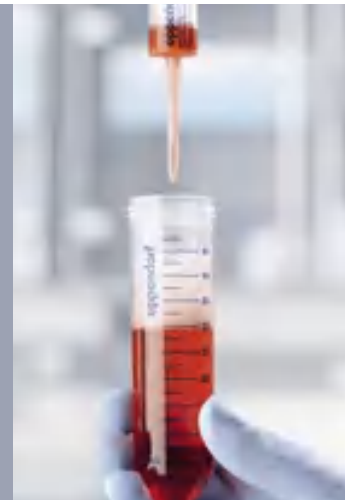

### Precision for challenging liquids

The Multipette M4 dispenser can precisely dispense even viscous, volatile, foaming and high-density liquids.

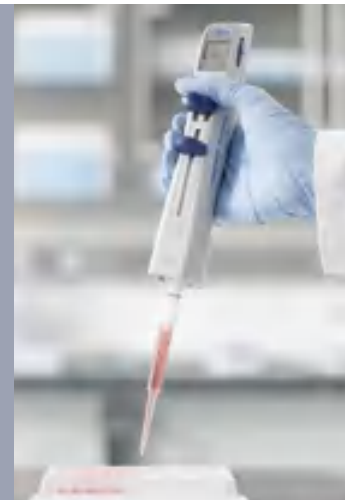

### Time saving

The Multipette M4 dispenser helps to make long dispensing series easier, safer, and faster.



> Pipette even challenging liquids like an expert: [www.eppendorf.com/pipetting](http://www.eppendorf.com/pipetting)

## Multipette® E3 / Multipette® E3x

The Multipette E3 and E3x make your everyday pipetting routines faster, easier and more precise. They combine the advantages of a positive displacement dispenser, time saving and precise handling of challenging liquids, with those of an electronic pipette. Even tough-to-handle liquids like cream can be dispensed in combination with the ViscoTip® dispenser tips.

The Multipette E3 and E3x offer the same benefits as the M4.

### Additional benefits of the Multipette E3 and E3x

- > Defined aspiration and dispensing speed for highest reproducibility of results (eight different speed levels)
- > Easy to read: Enlarged color display, optimized contrast, clear arrangement of all parameters
- > Store up to 225 different parameter settings to save programming time for routine applications
- > All selected parameters shown at one glance
- > Display/operating menu in 9 different languages



Feature	Multipette E3	Multipette E3x
High speed aspiration and dispensing with motorized piston	■	■
Automatic Combitips advanced® tip recognition	■	■
One button tip ejection	■	■
Volume range from 1 µl to 50 ml	■	■
Li-ion battery	■	■
Illuminated display	■	■
Automatic dispensing	■	■
Pipetting	■	■
Dispensing	■	■
Aspirate (aspiration of supernatants)		■
Titrate		■
Sequential dispensing		■
Combined aspiration and dispensing mode		■

> Multipette E3 and Multipette E3x are the experts for long series pipetting and liquids with demanding physical properties: [www.eppendorf.com/multipette-system](http://www.eppendorf.com/multipette-system)





# Combitips® advanced

In combination with the Multipette M4 and E3/E3x, Combitips advanced dispenser tips form an ideal system for a broad range of liquid handling applications.

### Combitips advanced benefits

- > Time saving for long dispensing/pipetting series
- > High-precision dispensing regardless of the physical properties of the liquid (e.g., viscosity, volatility, density, temperature...)
- > Prevention of aerosol contamination with hermetically sealed piston
- > Protection from radioactive and toxic substances
- > 9 available volume sizes (0.1 mL–50 mL) offer a maximum range of dispensing volumes
- > Individually color coded: Quick identification of the desired Combitips dispenser tips speeds up your workflow (color coding is also visible on packaging)



**Elongated tips (for 2.5 mL, 5 mL, 10 mL)**

Complete emptying of all common tubes prevents sample loss



### Variety and selection

With 9 volume sizes (0.1 mL to 50 mL) and 4 purity grades (Eppendorf Quality™, PCR clean, Eppendorf Biopur®, and Forensic DNA grade) you will always find the perfect Combitips dispenser tip for your application!

# ViscoTip®

Let it flow! The Multipette consumable ViscoTip is specialized on tough-to-handle liquids like cream. Therefore, ViscoTip dispenser tips naturally expands the broad range of applications for our often copied, never equaled Combitips advanced/Multipette system. For fast, precise and safe liquid handling.

### ViscoTip benefits

- > Specialized for liquids with a dynamic viscosity from 200 mPa\*s to 14,000 mPa\*s
- > For dispensing volumes from 100 µL to 10 mL in increments of 10 µL
- > Significantly lower operation force, thus speeding up work and reducing energy consumption
- > Automatic tip recognition and volume calculation
- > Free of experiment-interfering leachables and slip agents

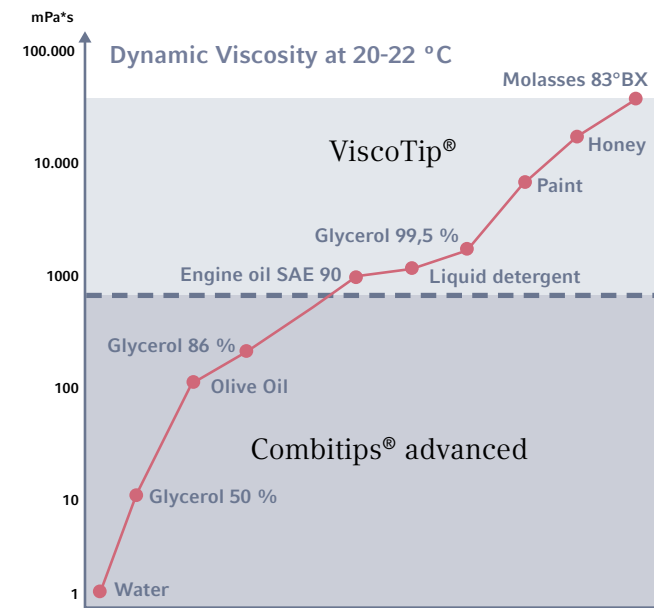

### Dynamic viscosity

The ViscoTip dispenser tips is specifically designed and optimized for handling high viscosity liquids up to 14,000 mPa\*s such as Glycerol 99.5%, Tween, oils, cremes, shampoos or honey. It sharply reduces operating forces while handling such liquids leading to enhanced ergonomics, increased working speed and longer charge life time of your Multipette dispenser battery.



> Choose the optimal Combitip for your volume with the help of our Combitip selection guide: [www.eppendorf.com/combitips-advanced](http://www.eppendorf.com/combitips-advanced)

> Find more information on [www.eppendorf.com/multipette-viscotip](http://www.eppendorf.com/multipette-viscotip)



## Easypet® 3

It has never been easier to combine speed, safety, precision and comfort. Experience a new dimension of speed control and precision by intuitive, convenient speed adjustment. You will always be informed about your battery status with the vibrantly backlit LED battery meter.



reddot design award  
winner 2013

## Pipet Helper®

The Pipet Helper is a pipet controller which covers the range of bulb and graduated pipettes from 0.1 to 200 mL. The valve system allows for convenient operation without effort. Low weight and optimized design with ergonomic arrangement of functions.

### Eppendorf Serological Pipets

The serological pipets are made of ultra-clear virgin polystyrene. They have a sterility assurance level of  $10^{-6}$  and a certified absence of detectable pyrogens, DNA, RNase and DNase, non-cytotoxic.



## Varipette® 4720

The Varipette is a continuously adjustable pipette that works according to the air-cushion and positive displacement principle. Thus the pipette is especially designed for precise pipetting of liquids with high vapor pressure or viscosity. The Varitip® P and S pipette tip systems are tailored to different vessels.



## Varispenser® 2/2x

Varispenser 2/2x bottle-top dispensers are ideal for dispensing aliquots of liquid from supply bottles. Available in 6 sizes for 0.2–100 mL and fully autoclavable. Varispenser 2x has a recirculation valve which prevents reagent loss while ventilating.



## Eppendorf Top Buret™

The Eppendorf Top Buret bottle-top burette sets standards for manual titration. Its pulse-free dispensing technique allows continuous dispensing of liquid with precision values within required limits.



## The Future is Now! Connect your Electronic Pipettes

Who doesn't enjoy greater freedom and convenience when it comes to pipetting? Be ahead of the curve! Switch to connected electronic pipettes and boost your individual pipetting skills while bringing teamwork up to a new level.

- > How quickly can you set your parameters?
- > How accurate are your results?
- > How do you work in teams when pipetting at the bench?

### Evolve your electronic pipette with the VisioNize® pipette manager

Our system connects multiple electronic pipettes, thereby not only improving speed and accuracy for a single user, but across your entire lab. Easily convert your Eppendorf Xplorer and Xplorer plus electronic pipettes into a connected electronic pipette with the WiFi module.

Connect to the VisioNize pipette manager and take your pipetting to the next level.



### How does the VisioNize pipette manager system work?



1. Convert Eppendorf Xplorer and Xplorer plus pipettes into connected electronic pipettes.

2. VisioNize pipette manager – External touch server establishes communication with connected electronic pipettes and tablets via WiFi technology.

3. Connect your tablet (Android and iOS) to work in parallel with other lab users.

## Eppendorf Pipette Holder System

Carousels, stands and wall mount devices: The Pipette Holder System is perfect for all users of handheld liquid handling instruments, who need a highly flexible system for their Eppendorf pipettes and Multipette multi-dispensers.

To save precious bench-top space, carousels carry both mechanical and electronic instruments.



Rotatable carousel holder in two variants to hold or hold & charge up to six instruments. High flexibility due to exchangeable adapters



Pipette stands as holder or including a charging function for single devices. High flexibility due to exchangeable adapter



Various holders for wall-mounting, installation on a shelf above the bench or inside biological safety cabinets



> Check requirements at:  
[www.eppendorf.com/visionize-pipette-manager](http://www.eppendorf.com/visionize-pipette-manager)



## epMotion® 96 and epMotion® 96xl

The Eppendorf epMotion 96 is a pipetting robot offering fast and precise, parallel 96-channel microplate processing with 96- and 384-well plates. The epMotion 96 is easy to use, and accessible for a wide range of applications like cell-based assays, ELISA, plate copying, 96-well plate handling and

magnetic bead-based clean-ups. Its ergonomic design and intuitive handling makes the epMotion 96 a great tool for anyone who needs accurate and reproducible liquid handling in 96-well format.

### Features

- > Large volume range of 0.5–300 µL (epMotion 96) or 5–1,000 µL (epMotion 96xl)
- > Use of different tip sizes without changing the pipetting head
- > Auto-detection of tip size
- > Intuitive and app-based software and convenient touch screen control
- > Intelligent, preset applications: aspiration, dilution, multi-dispense, pipette and mix, reverse pipetting and more
- > Individual speed settings to match different liquid types
- > 2-position slider for quick access to source and destination
- > Compact design to fit under the laminar flow hood
- > Reduced risk of repetitive strain injury (RSI)



> Watch our video for easy operation of epMotion 96 on our YouTube channel

## epMotion® 5070

The innovative epMotion 5070 is the most compact solution for accurate and reproducible automated pipetting in the epMotion family. With four worktable positions, the epMotion 5070 is a perfect match for routine applications, such as serial dilutions, reagent distribution, sample transfer from tubes to plates, sample normalization and automated immunoassays. Don't wait to achieve reproducible automated pipetting results.



### Features

- > 4 SBS/SLAS worktable and unlimited virtual positions
- > Maximum pipetting accuracy from 200 nL to 1,000 µL
- > Automatic exchange of two dispensing tools
- > Use of 1-channel and 8-channel dispensing tools
- > Optical sensor\*1 for detecting liquids, labware and tips
- > Completely contained housing including door safety mechanism
- > MultiCon PC controller by touch, mouse or keyboard, upgradable for barcode tracking and GLP software versions

\*1 Patent US 6,819,437 B2



epMotion 5070 is your ideal partner for easy and reliable liquid handling, such as PCR, normalizations and serial dilutions.

## epMotion® 5073

Why spend valuable time on challenging liquid handling procedures when you can achieve fast, accurate and reproducible NGS library prep, nucleic acid extraction and PCR setup with the epMotion 5073 automated liquid handler? Perfect for medium-throughput genomic applications and standard liquid handling tasks such as normalization, cherry picking, dilution series and reformatting.



### Features

- Same as 5070 plus
- > 6-position worktable
- > Automatic exchange of 3 dispensing tools
- > Option for gripper transport, 1 thermal module or Eppendorf ThermoMixer® module
- > CleanCap option for UV decontamination and HEPA air filter
- > MultiCon touch PC controller



## epMotion® 5075

The epMotion 5075 pipetting robot is a perfect match for high-throughput complex pipetting tasks. It offers the same precision and accuracy as the epMotion 5070 and 5073, making it the ideal tool for demanding applications such as the purification of nucleic acids with magnetic beads or silica, NGS library preparation or high-throughput routine applications such as PCR plate setup.

With 15 worktable positions, the option to automatically change pipetting tools and a useful plate gripper, the epMotion 5075 is one of the most flexible automated liquid handling systems available. The epMotion 5075 can be configured with CleanCap, up to 3 thermal modules, ThermoMixer and/or vacuum manifold.

### Features

- Same as 5073 plus
- > Up to 15 worktable positions
- > MultiCon PC controller with simulation, network and software upgrade options
- > Automatic exchange of 4 dispensing tools
- > Option for gripper and 1–3 thermal modules
- > System control by touch, mouse, keyboard or network
- > Available Eppendorf ThermoMixer® and/or Vacuum manifold
- > Available as CleanCap versions



> A set of customer testimonial videos can be found on our YouTube channel





# The Eppendorf PhysioCare Concept®

The mission of Eppendorf has always been to improve the living conditions of our customers. Nowadays, where people spend a lot of their time at work, the ergonomics of their tools and the whole work environment is becoming more important for your well-being. Thus the development of each Eppendorf pipette is based on three spheres that support the health of our customers.

Each of these spheres offers stringent ergonomic criteria which are directly involved in the users work process:



**The User:**  
The PhysioCare Concept guarantees an ergonomic design and an optimized product performance according to the needs of the individual.

**The Lab:**  
The PhysioCare Concept allows the uncomplicated integration of instruments in the lab as well as adhering to its specific requirements.

**The Laboratory Workflow:**  
The PhysioCare Concept ensures general support to enhance processes around the lab and improve the results of the whole organization.



## Supporting You – Eppendorf Services



Installation Service



Qualification Service



Preventive Maintenance



Calibration / Verification



Repair Service



Application Support



Training / Webinar

At Eppendorf, we are committed to providing reliable services to help you maintain premium performance, and maximum safety of your Eppendorf instruments. Our carefully designed service solutions are performed by our dedicated Application, Training and Technical Service teams worldwide.

Especially the precision and accuracy of the pipettes and the dispensing tools of semi-/automated liquid handling devices are important for the quality and reproducibility of all your work results. With the service portfolio from Eppendorf we offer you a range of quality maintenance and qualification services for different user requirements.

### Pipette Calibration Services

Pipettes are precision instruments with parts subject to normal wear and tear. This leads to imprecision over the time. Therefore, regular maintenance, calibration, and adjustment services by Eppendorf will help identify potential issues, and assure your pipettes and dispensers continue to generate reproducible results. Our new, globally available pipette service portfolio always follows the latest and strict international quality standards for calibration.

### epMotion® 96 Services

Maintaining and verifying your semi-automated pipette accuracy and precision is highly recommended to make sure your system still dispenses according to the manufacturer specifications. In the end you will receive assured results with your downstream applications and your valuable samples and reagents.

### Liquid Handling Training and Webinars

The operator's experience is also very important for achieving good pipetting results. In our most popular training you will learn about the principles of pipetting ergonomics, correct pipetting techniques, routine maintenance and pipette calibration.

### epMotion® Services

With our global epMotion® Service Agreements from cost-efficient to all-inclusive care packages and our Application Implementation Services we take the load off your shoulders by assuring consistent performance, continuous productivity and a long service life.





# Eppendorf Research® plus

**Eppendorf Research® plus**, single-channel, variable volume\*1

Volume range	Color code (for epT.I.P.S.®)	Volume	Systematic error*2		Random error*2		Order no.
			%	µL	%	µL	
0.1–2.5 µL	■ dark gray (for epT.I.P.S.® 10 µL)	0.1 µL	±48.0%	±0.048 µL	±12.0%	±0.012 µL	3123 000 012
		0.25 µL	±12.0%	±0.03 µL	±6.0%	±0.015 µL	
		1.25 µL	±2.5%	±0.031 µL	±1.5%	±0.019 µL	
		2.5 µL	±1.4%	±0.035 µL	±0.7%	±0.018 µL	
0.5–10 µL	■ medium gray (for epT.I.P.S.® 20 µL)	0.5 µL	±8.0%	±0.04 µL	±5.0%	±0.025 µL	3123 000 020
		1 µL	±2.5%	±0.025 µL	±1.8%	±0.018 µL	
		5 µL	±1.5%	±0.075 µL	±0.8%	±0.04 µL	
		10 µL	±1.0%	±0.1 µL	±0.4%	±0.04 µL	
2–20 µL	■ light gray (for epT.I.P.S.® 20 µL L)	2 µL	±5.0%	±0.1 µL	±1.5%	±0.03 µL	3123 000 098
		10 µL	±1.2%	±0.12 µL	±0.6%	±0.06 µL	
2–20 µL	■ yellow (for epT.I.P.S.® 200 µL)	2 µL	±5.0%	±0.1 µL	±1.5%	±0.03 µL	3123 000 039
		10 µL	±1.2%	±0.12 µL	±0.6%	±0.06 µL	
		20 µL	±1.0%	±0.2 µL	±0.3%	±0.06 µL	
		10 µL	±3.0%	±0.3 µL	±1.0%	±0.1 µL	
10–100 µL		50 µL	±1.0%	±0.5 µL	±0.3%	±0.15 µL	3123 000 047
		100 µL	±0.8%	±0.8 µL	±0.2%	±0.2 µL	
		20 µL	±2.5%	±0.5 µL	±0.7%	±0.14 µL	
20–200 µL		100 µL	±1.0%	±1.0 µL	±0.3%	±0.3 µL	3123 000 055
		200 µL	±0.6%	±1.2 µL	±0.2%	±0.4 µL	
		30 µL	±2.5%	±0.75 µL	±0.7%	±0.21 µL	
30–300 µL	■ orange (for epT.I.P.S.® 300 µL)	150 µL	±1.0%	±1.5 µL	±0.3%	±0.45 µL	3123 000 101
		300 µL	±0.6%	±1.8 µL	±0.2%	±0.6 µL	
		100 µL	±3.0%	±3.0 µL	±0.6%	±0.6 µL	
100–1,000 µL	■ blue (for epT.I.P.S.® 1,000 µL)	500 µL	±1.0%	±5.0 µL	±0.2%	±1.0 µL	3123 000 063
		1,000 µL	±0.6%	±6.0 µL	±0.2%	±2.0 µL	
		0.25 mL	±4.8%	±0.012 mL	±1.2%	±0.003 mL	
0.25–2.5 mL	■ red (for epT.I.P.S.® 2.5 mL)	1.25 mL	±0.8%	±0.01 mL	±0.2%	±0.0025 mL	3123 000 144
		2.5 mL	±0.6%	±0.015 mL	±0.2%	±0.005 mL	
0.5–5 mL	■ purple (for epT.I.P.S.® 5 mL)	0.5 mL	±2.4%	±0.012 mL	±0.6%	±0.003 mL	3123 000 071
		2.5 mL	±1.2%	±0.03 mL	±0.25%	±0.006 mL	
		5 mL	±0.6%	±0.03 mL	±0.15%	±0.008 mL	
1–10 mL	■ turquoise (for epT.I.P.S.® 10 mL)	1 mL	±3.0%	±0.03 mL	±0.6%	±0.006 mL	3123 000 080
		5 mL	±0.8%	±0.04 mL	±0.2%	±0.01 mL	
		10 mL	±0.6%	±0.06 mL	±0.15%	±0.015 mL	

\*1 Eppendorf Research® plus single-channel variable volume pipettes up to 1,000 µL include an epT.I.P.S.® box. The 5 mL and 10 mL versions include an epT.I.P.S.® sample bag.  
\*2 The error data, according to EN ISO 8655, only apply if original Eppendorf tips are used. Technical specifications are subject to change. Errors and omissions excepted.

# Eppendorf Research® plus

**Eppendorf Research® plus**, multi-channel, variable volume\*1

Volume range	Channels	Color code (for epT.I.P.S.®)	Volume	Systematic error*2		Random error*2		For 96-well plates		For 384-well plates		
				%	µL	%	µL	Order no. 8-channel	Order no. 12-channel	Order no. 16-channel	Order no. 24-channel	
0.5–10 µL		■ medium gray (for epT.I.P.S.® 20 µL)	0.5 µL	±12.0%	±0.06 µL	±8.0%	±0.04 µL	3125 000 010	3125 000 028	-	-	
			1 µL	±8.0%	±0.08 µL	±5.0%	±0.05 µL					
			5 µL	±4.0%	±0.2 µL	±2.0%	±0.1 µL					
			10 µL	±2.0%	±0.2 µL	±1.0%	±0.1 µL					
10–100 µL		■ yellow (for epT.I.P.S.® 200 µL)	10 µL	±3.0%	±0.3 µL	±2.0%	±0.2 µL	3125 000 036	3125 000 044	-	-	
			50 µL	±1.0%	±0.5 µL	±0.8%	±0.4 µL					
30–300 µL		■ orange (for epT.I.P.S.® 300 µL)	30 µL	±3.0%	±0.9 µL	±1.0%	±0.3 µL	3125 000 052	3125 000 060	-	-	
			150 µL	±1.0%	±1.5 µL	±0.5%	±0.75 µL					
			300 µL	±0.6%	±1.8 µL	±0.3%	±0.9 µL					
50–1,200 µL	8-channel	■ dark green	120 µL	±6.0%	±7.2 µL	±0.9%	±1.08 µL	3125 000 214	-	-	-	
			600 µL	±2.7%	±16.2 µL	±0.4%	±2.4 µL					
50–1,200 µL	12-channel	■ dark green	120 µL	±6.0%	±7.2 µL	±0.9%	±1.08 µL	-	3125 000 222	-	-	
			600 µL	±2.7%	±16.2 µL	±0.4%	±2.4 µL					
			1,200 µL	±1.2%	±14.4 µL	±0.3%	±3.6 µL					
1–100 µL	16-channel	■ light pink (for epT.I.P.S.® 384 20 µL)	1–20 µL	1 µL	±12%	±0.12 µL	±8%	±0.08 µL	-	-	3125 000 079	-
			2 µL	±8%	±0.16 µL	±5%	±0.1 µL					
			10 µL	±4%	±0.4 µL	±2%	±0.2 µL					
			20 µL	±2%	±0.4 µL	±1%	±0.2 µL					
			5 µL	±6%	±0.3 µL	±4%	±0.2 µL					
	24-channel	■ light pink (for epT.I.P.S.® 384 20 µL)	1–20 µL	1 µL	±12%	±0.12 µL	±8%	±0.08 µL	-	-	-	3125 000 087
			2 µL	±8%	±0.16 µL	±5%	±0.1 µL					
			10 µL	±4%	±0.4 µL	±2%	±0.2 µL					
			20 µL	±2%	±0.4 µL	±1%	±0.2 µL					
			5 µL	±6%	±0.3 µL	±4%	±0.2 µL					
5-100 µL		■ light yellow (for epT.I.P.S.® 384 100 µL)	5-100 µL	5 µL	±6%	±0.3 µL	±4%	±0.2 µL	-	-	-	3125 000 109
			10 µL	±3%	±0.3 µL	±2%	±0.2 µL					
			50 µL	±1.2%	±0.6 µL	±0.8%	±0.4 µL					
			100 µL	±1%	±1 µL	±0.6%	±0.6 µL					
			1 µL	±12%	±0.12 µL	±8%	±0.08 µL					

\*1 Eppendorf Research® plus multi-channel variable volume pipettes include an epT.I.P.S.® box.

## Eppendorf Research® plus

## Eppendorf Research® plus, single-channel, fixed volume

Volume	Color code	Systematic error*1		Random error*1		Order no.
10 µL	■ medium gray (for epT.I.P.S.® 20 µL)	±1.2%	±0.12 µL	±0.6%	±0.06 µL	3124 000 016
20 µL	■ light gray (for epT.I.P.S.® 20 µL L)	±0.8%	±0.16 µL	±0.3%	±0.06 µL	3124 000 032
10 µL	■ yellow (for epT.I.P.S.® 200 µL)	±1.2%	±0.12 µL	±0.6%	±0.06 µL	3124 000 024
20 µL		±1.0%	±0.2 µL	±0.3%	±0.06 µL	3124 000 040
25 µL		±1.0%	±0.25 µL	±0.3%	±0.08 µL	3124 000 059
50 µL		±0.7%	±0.35 µL	±0.3%	±0.15 µL	3124 000 067
100 µL		±0.6%	±0.6 µL	±0.2%	±0.2 µL	3124 000 075
200 µL		±0.6%	±1.2 µL	±0.2%	±0.4 µL	3124 000 083
200 µL	■ blue (for epT.I.P.S.® 1,000 µL)	±0.6%	±1.2 µL	±0.2%	±0.4 µL	3124 000 091
250 µL		±0.6%	±1.5 µL	±0.2%	±0.5 µL	3124 000 105
500 µL		±0.6%	±3.0 µL	±0.2%	±1.0 µL	3124 000 113
1 000 µL		±0.6%	±6.0 µL	±0.2%	±2.0 µL	3124 000 121

\*1 The error data, according to EN ISO 8655, only apply if original Eppendorf tips are used. Technical specifications are subject to change. Errors and omissions excepted.

Accessories	Order no.
<b>Tip-Tub reagent reservoir</b> , autoclavable reservoir for aspirating liquids with multi-channel pipettes, 1 set = 10 reservoirs and 10 lids	0030 058 607
<b>Eppendorf TrackIT</b>	–

Eppendorf Research® plus 3-pack including epT.I.P.S.® box and Eppendorf ballpoint pen	Order no.
<b>Option 1:</b> 0.5–10 µL, 10–100 µL, 100–1,000 µL	3123 000 900
<b>Option 2:</b> 2–20 µL yellow, 20–200 µL, 100–1,000 µL	3123 000 918
<b>Option 3:</b> 100–1,000 µL, 0.5–5 mL, 1–10 mL	3123 000 926

## Eppendorf Reference® 2

## Eppendorf Reference® 2, single-channel, variable volume\*1

Volume range	Color code	Volume	Systematic error*2		Random error*2		Order no.
0.1–2.5 µL	■ dark gray (for epT.I.P.S.® 10 µL)	0.1 µL	±48.0%	±0.048 µL	± 12.0%	±0.012 µL	4924 000 010
		0.25 µL	±12.0%	±0.03 µL	±6.0%	±0.015 µL	
		1.25 µL	±2.5%	±0.031 µL	±1.5%	±0.019 µL	
		2.5 µL	±1.4%	±0.035 µL	±0.7%	±0.018 µL	
0.5–10 µL	■ medium gray (for epT.I.P.S.® 20 µL)	0.5 µL	±8.0%	± 0.040 µL	±5.0%	±0.025 µL	4924 000 029
		1 µL	±2.5%	±0.025 µL	±1.8%	±0.018 µL	
		5 µL	±1.5%	±0.075 µL	±0.8%	±0.04 µL	
		10 µL	±1.0%	±0.10 µL	±0.4%	±0.04 µL	
2–20 µL	■ light gray (for epT.I.P.S.® 20 µL L)	2 µL	±3.0%	±0.06 µL	±1.5%	±0.03 µL	4924 000 037
		10 µL	±1.0%	±0.10 µL	±0.6%	±0.06 µL	
		20 µL	±0.8%	±0.16 µL	±0.3%	±0.06 µL	
		20 µL	±5.0%	±0.10 µL	±1.5%	±0.03 µL	
2–20 µL	■ yellow (for epT.I.P.S.® 200 µL)	10 µL	±1.2%	±0.12 µL	±0.6%	±0.06 µL	4924 000 045
		20 µL	±1.0%	±0.2 µL	±0.3%	±0.06 µL	
		10 µL	±3.0%	±0.3 µL	±0.7%	±0.07 µL	
		50 µL	±1.0%	±0.5 µL	±0.3%	±0.15 µL	
10–100 µL		100 µL	±0.8%	±0.8 µL	±0.20%	±0.20 µL	4924 000 053
		20 µL	±2.5%	±0.5 µL	±0.7%	±0.14 µL	
		100 µL	±1.0%	±1.0 µL	±0.3%	±0.3 µL	
		200 µL	±0.6%	±1.2 µL	±0.2%	±0.4 µL	
30–300 µL	■ orange (for epT.I.P.S.® 300 µL)	30 µL	±2.5%	±0.75 µL	±0.7%	±0.21 µL	4924 000 070
		150 µL	±1.0%	±1.5 µL	±0.3%	±0.45 µL	
		300 µL	±0.6%	±1.8 µL	±0.2%	±0.6 µL	
		100 µL	±3.0%	±3.0 µL	±0.6%	±0.6 µL	
100–1,000 µL	■ blue (for epT.I.P.S.® 1,000 µL)	500 µL	±1.0%	±5.0 µL	±0.2%	±1.0 µL	4924 000 088
		1,000 µL	±0.6%	±6.0 µL	±0.2%	±2.0 µL	
		0.25 mL	±4.8%	±0.012 mL	±1.2%	±0.003 mL	
		1.25 mL	±0.8%	±0.010 mL	±0.2%	±0.0025 mL	
0.5–5 mL	■ purple (for epT.I.P.S.® 5 mL)	2.5 mL	±0.6%	±0.015 mL	±0.2%	±0.005 mL	4924 000 100
		0.5 mL	±2.4%	±0.012 mL	±0.6%	±0.003 mL	
		2.5 mL	±1.2%	±0.030 mL	±0.25%	±0.006 mL	
		5.0 mL	±0.6%	±0.030 mL	±0.15%	±0.0075 mL	
1–10 mL	■ turquoise (for epT.I.P.S.® 10 mL)	1.0 mL	±3.0%	±0.030 mL	±0.6%	±0.006 mL	4924 000 118
		5.0 mL	±0.8%	±0.040 mL	±0.2%	±0.010 mL	
		10.0 mL	±0.6%	±0.060 mL	±0.15%	±0.015 mL	
		10.0 mL	±0.6%	±0.060 mL	±0.15%	±0.015 mL	

\*1 Eppendorf Reference® 2 single-channel variable volume pipettes up to 1,000 µL include an epT.I.P.S.® box. The 2.5 mL, 5 mL and 10 mL versions include an epT.I.P.S.® sample bag.  
\*2 The error data, according to EN ISO 8655, only apply if original Eppendorf tips are used. Technical specifications are subject to change. Errors and omissions excepted.

Accessories	Order no.
<b>Tip-Tub reagent reservoir</b> , autoclavable reservoir for aspirating liquids with multi-channel pipettes, 1 set = 10 reservoirs and 10 lids	0030 058 607

## Eppendorf Reference® 2

## Eppendorf Reference® 2, multi-channel, variable volume\*1

Volume range	Color code	Volume	Systematic error*2	Systematic error*2	For 96-well plates		
					Order no. 8-channel	Order no. 12-channel	
<b>Cone distance</b>							
9 mm							
0.5–10 µL	■ medium gray (for epT.I.P.S.® 20 µL)	0.5 µL	±12.0%	±0.06 µL	±8.0%	±0.04 µL	4926 000 018
		1 µL	±8.0%	±0.08 µL	±5.0%	±0.05 µL	
		5 µL	±4.0%	±0.2 µL	±2.0%	±0.1 µL	
		10 µL	±2.0%	±0.2 µL	±1.0%	±0.1 µL	
10–100 µL	■ yellow (for epT.I.P.S.® 200 µL)	10 µL	±3.0%	±0.3 µL	±2.0%	±0.2 µL	4926 000 034
		50 µL	±1.0%	±0.5 µL	±0.8%	±0.4 µL	
		100 µL	±0.8%	±0.8 µL	±0.3%	±0.3 µL	
		30 µL	±3.0%	±0.9 µL	±1.0%	±0.3 µL	
30–300 µL	■ orange (for epT.I.P.S.® 300 µL)	150 µL	±1.0%	±1.5 µL	±0.5%	±0.75 µL	4926 000 050
		300 µL	±0.6%	±1.8 µL	±0.3%	±0.9 µL	
		300 µL	±0.6%	±1.8 µL	±0.3%	±0.9 µL	

## Eppendorf Reference® 2, single-channel, fixed volume

Volume	Color code	Systematic error*2		Random error*2		Order no.
1 µL	■ dark gray (for epT.I.P.S.® 10 µL)	±2.5%	±0.025 µL	±1.8%	±0.018 µL	4925 000 014
2 µL		±2.0%	±0.04 µL	±1.2%	±0.024 µL	4925 000 022
5 µL	■ medium gray (for epT.I.P.S.® 20 µL)	±1.2%	±0.06 µL	±0.6%	±0.03 µL	4925 000 030
10 µL		±1.0%	±0.1 µL	±0.5%	±0.05 µL	4925 000 049
20 µL	■ light gray (for epT.I.P.S.® 20 µL L)	±0.8%	±0.16 µL	±0.3%	±0.06 µL	4925 000 065
10 µL	■ yellow (for epT.I.P.S.® 200 µL)	±1.2%	±0.12 µL	±0.6%	±0.06 µL	4925 000 057
20 µL		±1.0%	±0.2 µL	±0.3%	±0.06 µL	4925 000 073
25 µL		±1.0%	±0.25 µL	±0.3%	±0.075 µL	4925 000 081
50 µL		±0.7%	±0.35 µL	±0.3%	±0.15 µL	4925 000 090
100 µL		±0.6%	±0.6 µL	±0.2%	±0.2 µL	4925 000 103
200 µL		±0.6%	±1.2 µL	±0.2%	±0.4 µL	4925 000 111
200 µL	■ blue (for epT.I.P.S.® 1,000 µL)	±0.6%	±1.2 µL	±0.2%	±0.4 µL	4925 000 120
250 µL		±0.6%	±1.5 µL	±0.2%	±0.5 µL	4925 000 138
500 µL		±0.6%	±3.0 µL	±0.2%	±1.0 µL	4925 000 146
1,000 µL		±0.6%	±6.0 µL	±0.2%	±2.0 µL	4925 000 154
2 mL	■ red (for epT.I.P.S.® 2.5 mL)	±0.6%	±0.012 mL	±0.2%	±0.004 mL	4925 000 162
2.5 mL		±0.6%	±0.015 mL	±0.2%	±0.005 mL	4925 000 170

\*1 All Eppendorf Reference® 2 multichannel variable volume pipettes include an epT.I.P.S.® box.  
\*2 The error data, according to EN ISO 8655, only apply if original Eppendorf tips are used. Technical specifications are subject to change. Errors and omissions excepted.

Eppendorf Reference® 2, 3-Pack, incl. epT.I.P.S.® Box and Eppendorf ballpoint pen	Order no.
<b>Option 1:</b> 0.5–10 µL, 10–100 µL, 100–1,000 µL	4924 000 908
<b>Option 2:</b> 2–20 µL yellow, 20–200 µL, 100–1,000 µL	4924 000 916
<b>Option 3:</b> 100–1,000 µL, 0.5–5 mL, 1–10 mL	4924 000 924

# Eppendorf Xplorer®

## Eppendorf Xplorer®, single-channel, variable volume, incl. charger

Volume range	Color code	Volume	Systematic error*		Random error*		Order no.
			%	μL	%	μL	
0.5–10 μL	■ dark gray (for epT.I.P.S.® 20 μL)	1 μL	±2.5 %	±0.025 μL	±1.8 %	±0.018 μL	4861 000 015
		5 μL	±1.5 %	±0.075 μL	±0.8 %	±0.04 μL	
		10 μL	±1.0 %	±0.1 μL	±0.4 %	±0.04 μL	
1–20 μL	■ light gray (for epT.I.P.S.® 20 μL)	2 μL	±5.0 %	±0.1 μL	±1.5 %	±0.03 μL	4861 000 017
		10 μL	±1.2 %	±0.12 μL	±0.6 %	±0.06 μL	
		20 μL	±1.0 %	±0.2 μL	±0.3 %	±0.06 μL	
5–100 μL	■ yellow (for epT.I.P.S.® 200 μL)	10 μL	±2.0 %	±0.2 μL	±1.0 %	±0.1 μL	4861 000 023
		50 μL	±1.0 %	±0.5 μL	±0.3 %	±0.15 μL	
		100 μL	±0.8 %	±0.8 μL	±0.2 %	±0.2 μL	
10–200 μL	■ yellow (for epT.I.P.S.® 200 μL)	20 μL	±2.5 %	±0.5 μL	±0.7 %	±0.14 μL	4861 000 027
		100 μL	±1.0 %	±1.0 μL	±0.3 %	±0.3 μL	
		200 μL	±0.6 %	±1.2 μL	±0.2 %	±0.4 μL	
15–300 μL	■ orange (for epT.I.P.S.® 300 μL)	30 μL	±2.5 %	±0.75 μL	±0.7 %	±0.21 μL	4861 000 031
		150 μL	±1.0 %	±1.5 μL	±0.3 %	±0.45 μL	
		300 μL	±0.6 %	±1.8 μL	±0.2 %	±0.6 μL	
50–1,000 μL	■ blue (for epT.I.P.S.® 1,000 μL)	100 μL	±3.0 %	±3 μL	±0.6 %	±0.6 μL	4861 000 040
		500 μL	±1.0 %	±5 μL	±0.2 %	±1 μL	
		1,000 μL	±0.6 %	±6 μL	±0.2 %	±2 μL	
0.125–2.5 mL	■ red (for epT.I.P.S.® 2.5 mL)	250 μL	±4.8 %	±12 μL	±1.2 %	±3.0 μL	4861 000 044
		1,250 μL	±0.8 %	±10 μL	±0.2 %	±2.5 μL	
		2,500 μL	±0.6 %	±15 μL	±0.2 %	±5.0 μL	
0.25–5 mL	■ purple (for epT.I.P.S.® 5 mL)	500 μL	±3.0 %	±15 μL	±0.6 %	±3 μL	4861 000 058
		2,500 μL	±1.2 %	±30 μL	±0.3 %	±6.25 μL	
		5,000 μL	±0.6 %	±30 μL	±0.15 %	±7.5 μL	
0.5–10 mL	■ turquoise (for epT.I.P.S.® 10 mL)	1,000 μL	±3.0 %	±30 μL	±0.6 %	±6 μL	4861 000 066
		5,000 μL	±0.8 %	±40 μL	±0.2 %	±10 μL	
		10,000 μL	±0.6 %	±60 μL	±0.15 %	±15 μL	

## Eppendorf Xplorer®, multi-channel, variable volume, incl. charger

Volume range	Color code	Volume	Systematic error*		Random error*		For 96-well plates	
			%	μL	%	μL	Order no. 8-channel	Order no. 12-channel
0.5–10 μL	■ medium gray (for epT.I.P.S.® 20 μL)	1 μL	±5.0 %	±0.05 μL	±3.0 %	±0.03 μL	4861 000 104	4861 000 112
		5 μL	±3.0 %	±0.15 μL	±1.5 %	±0.075 μL		
		10 μL	±2.0 %	±0.2 μL	±0.8 %	±0.08 μL		
5–100 μL	■ yellow (for epT.I.P.S.® 200 μL)	10 μL	±2.0 %	±0.2 μL	±2.0 %	±0.2 μL	4861 000 120	4861 000 139
		50 μL	±1.0 %	±0.5 μL	±0.8 %	±0.4 μL		
		100 μL	±0.8 %	±0.8 μL	±0.25 %	±0.25 μL		
15–300 μL	■ orange (for epT.I.P.S.® 300 μL)	30 μL	±2.5 %	±0.75 μL	±1.0 %	±0.3 μL	4861 000 147	4861 000 155
		150 μL	±1.0 %	±1.5 μL	±0.5 %	±0.75 μL		
		300 μL	±0.6 %	±1.8 μL	±0.25 %	±0.75 μL		
50–1,200 μL	■ green (for epT.I.P.S.® 1,200 μL)	120 μL	±6.0 %	±7.2 μL	±0.9 %	±1.08 μL	4861 000 163	4861 000 171
		600 μL	±2.7 %	±16.2 μL	±0.4 %	±2.4 μL		
		1,200 μL	±1.2 %	±14.4 μL	±0.3 %	±3.6 μL		

\* The error data, according to EN ISO 8655, only apply if original Eppendorf tips are used. Technical specifications are subject to change. Errors and omissions excepted.



# Eppendorf Xplorer® plus

## Eppendorf Xplorer® plus, single-channel, variable volume, incl. charger

Volume range	Color code	Volume	Systematic error*	Random error*	Order no.
0.5–10 µL	■ medium gray (for epT.I.P.S.® 20 µL)	1 µL	±2.5 %	±0.025 µL	4861 000 708
		5 µL	±1.5 %	±0.075 µL	
		10 µL	±1.0 %	±0.1 µL	
1–20 µL	■ light gray (for epT.I.P.S.® 20 µL)	2 µL	±5.0 %	±0.1 µL	4861 000 710
		10 µL	±1.2 %	±0.12 µL	
		20 µL	±1.0 %	±0.2 µL	
5–100 µL	■ yellow (for epT.I.P.S.® 200 µL)	10 µL	±2.0 %	±0.2 µL	4861 000 716
		50 µL	±1.0 %	±0.5 µL	
		100 µL	±0.8 %	±0.8 µL	
10–200 µL	■ yellow (for epT.I.P.S.® 200 µL)	20 µL	±2.5 %	±0.5 µL	4861 000 720
		100 µL	±1.0 %	±1.0 µL	
		200 µL	±0.6 %	±1.2 µL	
15–300 µL	■ orange (for epT.I.P.S.® 300 µL)	30 µL	±2.5 %	±0.75 µL	4861 000 724
		150 µL	±1.0 %	±1.5 µL	
		300 µL	±0.6 %	±1.8 µL	
50–1,000 µL	■ blue (for epT.I.P.S.® 1,000 µL)	100 µL	±3.0 %	±3 µL	4861 000 732
		500 µL	±1.0 %	±5 µL	
		1,000 µL	±0.6 %	±6 µL	
0.125–2.5 mL	■ red (for epT.I.P.S.® 2.5 mL)	250 µL	±4.8 %	±12 µL	4861 000 736
		1,250 µL	±0.8 %	±10 µL	
		2,500 µL	±0.6 %	±15 µL	
0.25–5 mL	■ purple (for epT.I.P.S.® 5 mL)	500 µL	±3.0 %	±15 µL	4861 000 740
		2,500 µL	±1.2 %	±30 µL	
		5,000 µL	±0.6 %	±30 µL	
0.5–10 mL	■ turquoise (for epT.I.P.S.® 10 mL)	1,000 µL	±3.0 %	±30 µL	4861 000 759
		5,000 µL	±0.8 %	±40 µL	
		10,000 µL	±0.6 %	±60 µL	

## Eppendorf Xplorer® plus, 8/12-channel, variable volume, incl. charger

Volume range	Color code	Volume	Systematic error*	Random error*	Order no. 8-channel	Order no. 12-channel
Cone distance						
9 mm						
0.5–10 µL	■ medium gray (for epT.I.P.S.® 20 µL)	1 µL	±5.0 %	±0.05 µL	4861 000 767	4861 000 775
		5 µL	±3.0 %	±0.15 µL		
		10 µL	±2.0 %	±0.2 µL		
5–100 µL	■ yellow (for epT.I.P.S.® 200 µL)	10 µL	±2.0 %	±0.2 µL	4861 000 783	4861 000 791
		50 µL	±1.0 %	±0.5 µL		
		100 µL	±0.8 %	±0.8 µL		
15–300 µL	■ orange (for epT.I.P.S.® 300 µL)	30 µL	±2.5 %	±0.75 µL	4861 000 805	4861 000 813
		150 µL	±1.0 %	±1.5 µL		
		300 µL	±0.6 %	±1.8 µL		
50–1,200 µL	■ green (for epT.I.P.S.® 1,200 µL)	120 µL	±6.0 %	±7.2 µL	4861 000 821	4861 000 830
		600 µL	±2.7 %	±16.2 µL		
		1,200 µL	±1.2 %	±14.4 µL		

\* The error data, according to EN ISO 8655, only apply if original Eppendorf tips are used. Technical specifications are subject to change. Errors and omissions excepted.

## Eppendorf Xplorer® plus, 16-/24-channel, variable volume, incl. charger for 384-well plates

Volume range	Channels	Color code	Volume	Systematic error*	Random error*	Order no. 16-channel	Order no. 24-channel
Cone distance							
4.5 mm							
1–20 µL	16	■ light pink (for epT.I.P.S.® 384 20 µL)	2 µL	±8.0 %	±0.16 µL	4861 000 778	–
			10 µL	±4.0 %	±0.4 µL		
			20 µL	±2.0 %	±0.4 µL		
5–100 µL	16	■ light yellow (for epT.I.P.S.® 384 100 µL)	10 µL	±3.0 %	±0.3 µL	4861 000 792	–
			50 µL	±1.2 %	±0.6 µL		
			100 µL	±1.0 %	±1.0 µL		
1–20 µL	24	■ light pink (for epT.I.P.S.® 384 20 µL)	2 µL	±8.0 %	±0.16 µL	–	4861 000 779
			10 µL	±4.0 %	±0.4 µL		
			20 µL	±2.0 %	±0.4 µL		
5–100 µL	24	■ light yellow (for epT.I.P.S.® 384 100 µL)	10 µL	±3.0 %	±0.3 µL	–	4861 000 793
			50 µL	±1.2 %	±0.6 µL		
			100 µL	±1.0 %	±1.0 µL		

\* The error data, according to EN ISO 8655, only apply if original Eppendorf tips are used. Technical specifications are subject to change. Errors and omissions excepted.

# VisioNize® pipette manager

Description	Order no.
<b>VisioNize® pipette manager</b> , an external touch server enabling communication with connected electronic pipettes	1004 000 001
<b>Eppendorf Xplorer® connect</b> , WiFi module incl. battery for Eppendorf Xplorer	4861 000 970

Note: The VisioNize pipette manager is not available worldwide. Please contact your Eppendorf Sales Representative for more information.

# Move It® Adjustable Tip Spacing Pipettes

**Eppendorf Research® plus Move It®**, mechanical, multi-channel, variable volume

No. of channels	Volume	Color code	Order no.
4-channel	30–300 µL	orange	3125 000 150
	120–1,200 µL	dark green	3125 000 184
6-channel	30–300 µL	orange	3125 000 168
	120–1,200 µL	dark green	3125 000 192
8-channel	1–20 µL	light pink	3125 000 117
	5–100 µL	light yellow	3125 000 133
	30–300 µL	orange	3125 000 176
	120–1,200 µL	dark green	3125 000 206
12-channel	1–20 µL	light pink	3125 000 125
	5–100 µL	light yellow	3125 000 141

**Eppendorf Xplorer® plus Move It®**, electronic, multi-channel, variable volume, incl. charger

No. of channels	Volume	Color code	Order no.
4-channel	15–300 µL	orange	4861 000 816
	50–1,200 µL	green	4861 000 833
6-channel	15–300 µL	orange	4861 000 817
	50–1,200 µL	green	4861 000 834
8-channel	1–20 µL	light pink	4861 000 781
	5–100 µL	light yellow	4861 000 794
	15–300 µL	orange	4861 000 818
	50–1,200 µL	green	4861 000 835
12-channel	1–20 µL	light pink	4861 000 782
	5–100 µL	light yellow	4861 000 795

All models available as electronic Xplorer plus or mechanical Research plus variant.



Vessel Format	Type of tips Pipette Electronic Mechanical	epT.I.P.S.®			epT.I.P.S.® 384	
		Xplorer® plus, Eppendorf Research® plus			Xplorer® plus, Eppendorf Research® plus	
No. of channels		4	6	8	8	12
Volume (µL)		300 / 1,200	300 / 1,200	300 / 1,200	20 / 100	20 / 100
Tip distance (mm)		9–33	9–20	9–14	4.5–14	4.5–9
384 Wells (Tip distance 4.5 mm)		-	-	-	■	■
96 Wells (Tip distance 9 mm)		■	■	■	■	■
48 Wells (Tip distance 13 mm)		■	■	■	■	-
24 Wells (Tip distance 19 mm)		■	■	-	-	-
12 Wells (Tip distance 26 mm)		■	-	-	-	-
1.5 / 2.0 / 5.0 mL Tube (Tip distance min. – max.: 9 mm – 33 mm)		■	-	-	-	-
1.5 / 2.0 / 5.0 mL Tube (Tip distance min. – max.: 9 mm – 20 mm)		-	■	-	-	-
1.5 / 2.0 / 5.0 mL Tube (Tip distance min. – max.: 9 mm – 14 mm 4.5 mm – 14 mm)		-	-	■	■	-
Agarose gel		■	■	■	■	■

\* Limited suitability due to volume and size of tips

## Easypet® 3

Description	Order no.
<b>Easypet® 3</b> , incl. power supply and Lithium-polymer rechargeable battery, wall mount, shelf stand, and two membrane filters (unsterile) 0.45 µm	4430 000 018
<b>Membrane filter</b> , sterile, 0.45 µm, set of 5	4421 601 009
<b>Membrane filter</b> , sterile, 0.2 µm, pack of 5	4430 606 005
<b>Lithium-polymer rechargeable battery</b> for Easypet® 3	4430 605 009
<b>Pipette Holder</b> , for one Eppendorf Easypet® 3, for wall mounting, sticky tape included	4430 604 002

## Eppendorf Pipette Holder System

Description	Order No.
<b>Pipette Carousel 2</b> , for 6 Eppendorf Research®, Eppendorf Research® plus, Eppendorf Reference®, Eppendorf Reference® 2 or Biomaster®, additional pipette holders are optionally available	3116 000 015
<b>Charger Carousel 2</b> , for 6 Eppendorf Xplorer® or Eppendorf Xplorer® plus, mains/power adapter included, additional charger shells and pipette holders are optionally available	3116 000 023
<b>Charger Stand 2</b> , for one Eppendorf Xplorer® or Eppendorf Xplorer® plus, operated with mains/power adapter supplied with Eppendorf Xplorer® or Eppendorf Xplorer® plus	3116 000 031
<b>Charger Stand 2</b> , for one Multipette® E3/E3x or Multipette® stream/Xstream, operated with mains/power adapter supplied with Multipette® E3/E3x or Multipette® stream/Xstream	3116 000 040
<b>Pipette Stand 2</b> , for one Multipette® M4, without charging functionality, additional pipette holders are optionally available	3116 000 058
<b>Pipette Holder 2</b> , for one Eppendorf Research®, Eppendorf Research® plus, Eppendorf Reference®, Eppendorf Reference® 2 or Biomaster®, for Pipette Carousel 2 and Charger Carousel 2 or wall mounting, sticky tape included	3116 000 112
<b>Pipette Holder 2</b> , for one Eppendorf Xplorer® or Eppendorf Xplorer® plus, for Pipette Carousel 2 or wall mounting, sticky tape included, without charging functionality	3116 000 120
<b>Pipette Holder 2</b> , for one Multipette® E3/E3x or Multipette® stream/Xstream, for Pipette Carousel 2 or wall mounting, sticky tape included, without charging functionality	3116 000 139
<b>Pipette Holder 2</b> , for one Multipette® M4, for Pipette Carousel 2 and Charger Carousel 2 or wall mounting, sticky tape included, without charging functionality	3116 000 147
<b>Charger Shell 2</b> , for one Eppendorf Xplorer® or Eppendorf Xplorer® plus, for Charger Carousel 2, with charging functionality	3116 602 007
<b>Charger Shell 2</b> , for one Multipette® E3/E3x or Multipette® stream/Xstream, for Charger Carousel 2, with charging functionality	3116 603 003

## Pipet Helper®

Description	Order no.
<b>Pipet Helper®</b> , 0.1–100 mL	4423 000 010
<b>Membrane filter</b> , for Pipet Helper®, 3 µm, not sterile, (pack of 10)	4423 601 014

## Multipette® M4

Description	Order no.
<b>Multipette® M4</b> , incl. 1x Combitips® advanced 2.5 mL tip and holder for wall mounting or pipette carousel, 1 µL – 10 mL	4982 000 012
<b>Multipette® M4 Starter Kit</b> , incl. Combitips® advanced Rack, Combitips® advanced assortment pack (1 tip of each size) and holder, 1 µL – 10 mL	4982 000 314

## Multipette® E3/E3x

Description	Order no.
<b>Multipette® E3</b> , incl. charging cable and Combitips® advanced assortment pack (1 tip of each size), 1 µL – 50 mL	4987 000 010
<b>Multipette® E3 bundle with charger stand</b> , incl. charging cable, Charger Stand 2 and Combitips® advanced assortment pack, 1 µL – 50 mL	4987 000 371
<b>Multipette® E3x</b> , incl. charging cable and Combitips® advanced assortment pack (1 tip of each size), 1 µL – 50 mL	4987 000 029
<b>Multipette® E3x bundle with charger stand</b> , incl. charging cable, Charger Stand 2 and Combitips® advanced assortment pack, 1 µL – 50 mL	4987 000 380



## Combitips® advanced

Volume	Color code	Order no. Eppendorf Quality box of 100 pcs. (4 bags x 25 pcs.)	Order no. PCR clean*1 box of 100 pcs., 4 bags (zip-lock) x 25 pcs.	Order no. Eppendorf Biopur**2 box of 100 pcs. (individually wrapped)	Order no. Forensic DNA Grade box of 100 pcs. (individually wrapped)
0.1 mL	☐ White	0030 089 405	0030 089 766	0030 089 618	–
0.2 mL	■ Light blue	0030 089 413	0030 089 774	0030 089 626	–
0.5 mL	■ Purple	0030 089 421	0030 089 782	0030 089 634	–
1 mL	■ Yellow	0030 089 430	0030 089 790	0030 089 642	0030 089 855
2.5 mL	■ Green	0030 089 448	0030 089 804	0030 089 650	0030 089 863
5 mL	■ Blue	0030 089 456	0030 089 812	0030 089 669	0030 089 871
10 mL	■ Orange	0030 089 464	0030 089 820	0030 089 677	–
25 mL*3	■ Red	0030 089 472	0030 089 839	0030 089 685	–
50 mL*3	■ Light gray	0030 089 480	0030 089 847	0030 089 693	–
<b>ViscoTip®</b>					
10 mL	■ Orange	0030 089 936	–	–	–
<b>Accessories</b>					
25 mL adapter (1 pc.)	■ Red	0030 089 715			
25 mL adapter (7 pcs.)	■ Red			0030 089 731	
50 mL adapter (1 pc.)	■ Light gray	0030 089 723			
50 mL adapter (7 pcs.)	■ Light gray			0030 089 740	
Combitips® advanced Rack (for 8 Combitips® advanced, 0.1 mL–10 mL)		0030 089 758			
Combitips® advanced assortment pack (1 Combitip of each size, incl. adapters)		0030 089 936			

\*1 PCR clean: batch tested and certified to be free of: human DNA, DNase, RNase, PCR inhibitors

\*\* Eppendorf Biopur®: batch tested and certified to be sterile and free of: human and bacterial DNA, DNase, RNase, PCR inhibitors, ATP, pyrogen

\*3 4 boxes of 25 pcs. each. Each box contains an adapter.

## Varipette® 4720

Description	Order no.
<b>Varipette® 4720</b> , with continuous volume selection in the 1–10 mL range	4720 000 011
<b>Varitips® S Starter Kit</b> , consisting of 100 Maxitips, 10 dispensing parts, 10 valves	0030 050 525
<b>Varitips® P</b> , to remove liquid from smaller vessels, 100 pieces	0030 048 130
<b>Varitips® S dispensing part</b> , 30 pieces	0030 050 533
<b>Varitips® S</b> , graduated, 200 pieces	0030 050 568
<b>Varitips® S valve</b> , 100 pieces	0030 050 541

## Varispenser® 2/2x

Volume	Thread	Thread adapter incl.	Order no.
<b>Varispenser® 2</b>			
0.2–2 mL	GL 45	GL 25, GL 28/ S 28, GL 32, GL 38, S 40	4966 000 010
0.5–5 mL	GL 45	GL 25, GL 28/ S 28, GL 32, GL 38, S 40	4966 000 029
1–10 mL	GL 45	GL 25, GL 28/ S 28, GL 32, GL 38, S 40	4966 000 037
2.5–25 mL	GL 45	GL 32, GL 38, S 40	4966 000 045
5–50 mL	GL 45	GL 32, GL 38, S 40	4966 000 053
10–100 mL	GL 45	GL 32, GL 38, S 40	4966 000 061
<b>Varispenser® 2x</b>			
0.2–2 mL	GL 45	GL 25, GL 28/ S 28, GL 32, GL 38, S 40	4967 000 014
0.5–5 mL	GL 45	GL 25, GL 28/ S 28, GL 32, GL 38, S 40	4967 000 022
1–10 mL	GL 45	GL 25, GL 28/ S 28, GL 32, GL 38, S 40	4967 000 030
2.5–25 mL	GL 45	GL 32, GL 38, S 40	4967 000 049
5–50 mL	GL 45	GL 32, GL 38, S 40	4967 000 057
10–100 mL	GL 45	GL 32, GL 38, S 40	4967 000 065

## Eppendorf Top Buret™

Description	Volume	With three adapters for outer diameter (mm)	Order no.
<b>Eppendorf Top Buret™ M</b>	2.5 mL per rotation	32, 38, 40	4965 000 017
<b>Eppendorf Top Buret™ H</b>	5.0 mL per rotation	32, 38, 40	4965 000 025
<b>Dry tube</b>			4960 851 000

# epMotion®

Description	Order no.
<b>epMotion® 96</b> , semi-automated electronic pipette for parallel 96 channel microplate processing (without iPod® controller), 100–240 V ±10 %/50–60 Hz ±5 %, 0.5–300 µL	5069 000 012
<b>epMotion® 96, with 2-position slider</b> , semi-automated electronic pipette for parallel 96 channel microplate processing (without iPod® controller), 100–240 V ±10 %/50–60 Hz ±5 %, 0.5–300 µL	5069 000 110
<b>epMotion® 96xl</b> , semi-automated electronic pipette for parallel 96 channel microplate processing (without iPod® controller), 5–1,000 µL	5069 000 217
<b>epMotion® 96xl, with 2-position slider</b> , semi-automated electronic pipette for parallel 96 channel microplate processing (without iPod® controller), 5–1,000 µL	5069 000 314
<b>epMotion® 5070 MultiCon</b> , completely contained housing, system incl. Eppendorf MultiCon, epBlue™ software and LH assistant, keyboard, mouse, waste box, 100–240 V ±10 %/50–60 Hz ±5 %, 0.2 µL–1 mL	5070 000 282
<b>epMotion® 5070 MultiCon PCR Solution</b> , includes MultiCon PC, dispensing tool (TS 50), PCR specific accessories, 100–240 V ±10 %/50–60 Hz ±5 % (EU), 0.2 µL–1 mL	5070 000 948
<b>epMotion® 5073l MultiCon</b> , completely contained housing system incl. Eppendorf MultiCon, epBlue™ software and LH assistant, keyboard, mouse, waste box, 100–240 V ±10 %/50–60 Hz ±5 %, 0.2 µL–1 mL	5073 000 590
<b>epMotion® 5073t MultiCon</b> , completely contained housing, system incl. Eppendorf MultiCon, Eppendorf ThermoMixer®, epBlue™ software and Prep assistant, keyboard, mouse, waste box, 100–240 V ±10 %/50–60 Hz ±5 %, 0.2 µL–1 mL	5073 000 345
<b>epMotion® 5073t NGS solution</b> , MultiCon PC, 3 tools, gripper, plus NGS specific accessories and consumables, waste bags and holder, 100–240 V ±10 %/50–60 Hz ±5 %, 0.2 µL–1 mL	5073 000 978
<b>epMotion® 5075l</b> , basic device incl. epBlue™ software, mouse, waste box, 100–240 V ±10 %/50–60 Hz ±5 %, 0.2 µL–1 mL	5075 000 301
<b>epMotion® 5075v</b> , basic device incl. vacuum system, gripper, vac frame 2, vac frame holder, epBlue™ software, mouse, waste box, 100–240 V ±10 %/50–60 Hz ±5 %, 0.2 µL–1 mL	5075 000 303
<b>epMotion® 5075t</b> , basic device incl. Eppendorf ThermoMixer®, epBlue™ software, mouse, waste box, 100–240 V ±10 %/50–60 Hz ±5 %, 0.2 µL–1 mL	5075 000 302
<b>epMotion® 5075t NGS solution</b> , package with completely contained housing, MultiCon PC, Enhanced feature set 1, C2 thermal module, dispensing tools, plus NGS specific accessories, plus NGS specific consumables to start automated library preparation, 100–240 V ±10 %/50–60 Hz ±5 %	5075 000 962
<b>epMotion® 5075tc NGS solution</b> , package with CleanCap, MultiCon PC, Enhanced feature set 1, C2 thermal module, dispensing tools, plus NGS specific accessories, plus NGS specific consumables to start automated library preparation, 100–240 V ±10 %/50–60 Hz ±5 %	5075 000 963
<b>epMotion® 5075vt</b> , basic device incl. vacuum system, gripper, vac frame 2, vac frame holder, Eppendorf ThermoMixer®, epBlue™ software, mouse, waste box, 100–240 V ±10 %/50–60 Hz ±5 %, 0.2 µL–1 mL	5075 000 304

# Eppendorf Handling Solutions

**Increase your knowledge and become a liquid handling professional!**

Are you working with the following liquids?

- > Viscous
- > Foaming
- > High vapor pressure
- > High density
- > Infectious



epMotion® – holder: Eppendorf AG,  
 twin.tec® – holder: Eppendorf AG,  
 Mastercycler® – holder: Eppendorf AG  
 Red Dot Logo – holder: Red Dot GmbH & Co. KG, Germany

epMotion® M5073/M5073c/5075m: This product and its use may be covered by one or more patents owned by Gen-Probe Incorporated. The purchase price for this product includes only limited, nontransferable rights under certain claims of certain patents owned by Gen-Probe Incorporated to use this product for research purposes only. No other rights are conveyed. Purchaser is not granted any rights under patents of Gen-Probe Incorporated to use this product for any commercial use. Further information regarding purchasing a license under patents of Gen-Probe Incorporated to use this product for any other purposes, including, without limitation, for commercial use, may be obtained by contacting Gen-Probe Incorporated, Attn: Business Development Department, 10210 Genetic Center Drive, San Diego, California 92121-4362, U.S.A.

Eppendorf®, the Eppendorf Brand Design, epServices® logo, epServices for Premium Performance®, Eppendorf Reference®, Pipet Helper®, Biomaster®, Biopur®, Multipette®, Eppendorf Research®, Xplorer®, Move It®, PhysioCare Concept®, ep.T.I.P.S.®, Combitips advanced®, Varispenser®, Easypet®, ep Dualfilter T.I.P.S.®, Varipette®, Varitips®, Mastertip®, ViscoTip®, epMotion®, Eppendorf ThermoMixer® and VisioNize® are registered trademarks of Eppendorf AG, Germany. Eppendorf TopBuret™, epBlue™, Eppendorf Quality™ and Eppendorf MagSep™ are trademarks of Eppendorf AG, Germany. U.S. Design Patents are listed on www.eppendorf.com/ip. All rights reserved, including graphics and pictures.  
 Order No. APIP F12 020/GB6/0T/0921/SSO/STEF · Copyright © 2021 by Eppendorf AG.