

EasyPlus™ Refractometry

Easy R40 / Easy Brix

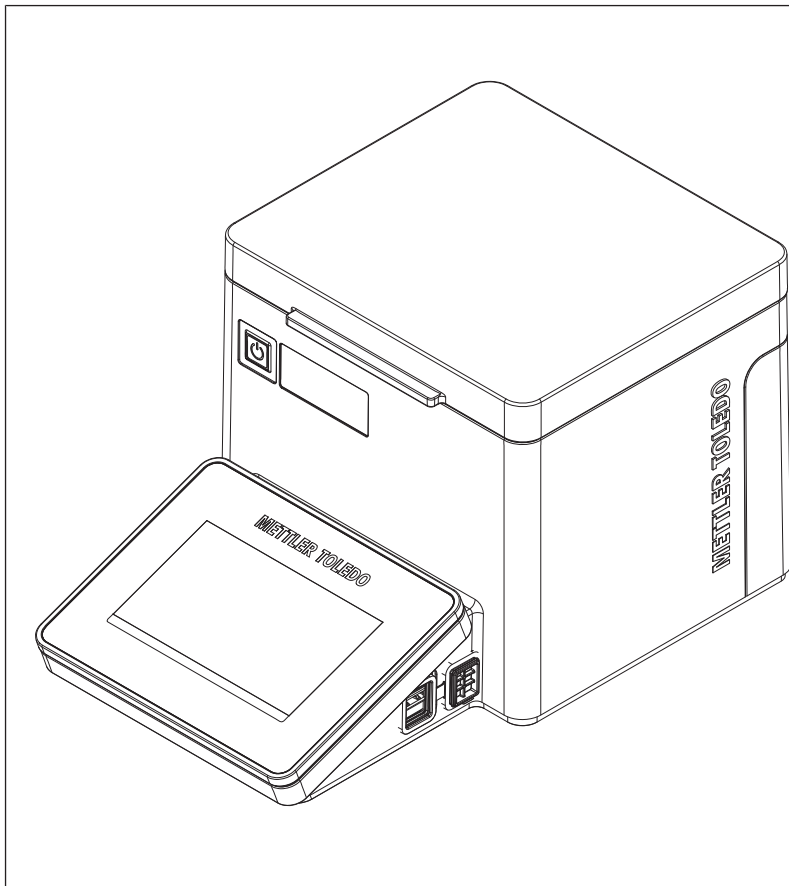

METTLER TOLEDO

Table of Contents

1	Introduction	3
2	Safety information	3
2.1	Definitions of signal words and warning symbols	4
2.2	Product specific safety notes	4
3	Design and function	6
3.1	Overview refractometer	6
3.2	Rear panel	7
3.3	Overview of functions	7
3.4	Menu structure	8
4	Installation and commissioning	8
4.1	Scope of delivery	8
4.2	Download the Reference Manual	9
4.3	Unpack the refractometer	9
4.4	Position the refractometer	10
4.5	Connect the refractometer to the power supply	10
4.6	Disconnect the refractometer from the power supply	11
4.7	Change the language	11
4.8	Configure the refractometer	11
5	Operation	11
5.1	Start up the refractometer	11
5.2	Shut down the refractometer	12
5.3	View parameter descriptions	12
5.4	Typical phases of a refractive-index determination	12
5.4.1	Fill the measuring cell and measure the refractive index	12
5.4.2	Rinse the measuring cell	13
5.4.3	Dry the measuring cell	13
5.5	Example: Brix determination of apple juice	13
5.5.1	Configure the Measure method	14
5.5.2	Fill the measuring cell and measure the refractive index	14
5.5.3	Clean the measuring cell	16
6	Maintenance	17
6.1	Maintenance schedule	17
6.2	Clean the measuring cell	18
6.2.1	Typical phases of cleaning the measuring cell	18
6.2.2	Example: clean using deionized water	18
6.3	Check the measurement accuracy	19
6.3.1	Typical phases of checking the measurement accuracy	19
6.3.2	Example: test with a SimpleCheck™ water-standard	19
6.3.2.1	Configure the Test method	19
6.3.2.2	Fill the measuring cell and measure the refractive index	20
6.3.2.3	Clean the measuring cell	21
6.3.3	Measures if the test fails	22
6.4	Clean the refractometer	22
6.4.1	Clean the housing and the magnetic lid	22
6.5	Replace the magnetic lid	23
6.5.1	Remove the magnetic lid	23
6.5.2	Install the magnetic lid	23
6.6	Replace the O-ring of the measuring-cell cover	23
6.6.1	Remove the O-ring	23

6.6.2	Install the O-ring	24
6.7	View the firmware version and other system information.....	25
6.8	Prepare the refractometer for storage.....	25
6.9	Transport the refractometer.....	25
6.10	Dispose of the refractometer.....	25
<hr/>		
7	Technical data	25
7.1	Refractometer	26
7.2	Measurement	26
7.3	Compliance information	26

1 Introduction

Thank you for choosing a METTLER TOLEDO refractometer. The refractometers Easy R40 and Easy Brix are easy-to-operate instruments for measuring refractive indexes and related values.

About this document

This document provides you with the information you need to get started with your METTLER TOLEDO refractometer.

The instructions in this document refer to the refractometers Easy R40 and Easy Brix running firmware version 2.0 or higher. The screenshots show the user interface of an Easy R40 refractometer.



For a full description of the refractometer and its functions, refer to the Reference Manual supplied online.

The firmware license is subject to the End User License Agreement EULA version 3.0. See the following link for the license text:

For third party licenses and open source attribution files, see the following link:

If you have any additional questions, contact your authorized METTLER TOLEDO service representative or dealer.

Conventions and symbols



Refers to an external document.

Elements of instructions

- Prerequisites
- 1 Steps
- 2 Steps
 - ⇒ Intermediate results
- 3 Steps
 - ⇒ Results

See also

-  View the firmware version and other system information ► Page 25

2 Safety information

Two documents named "User Manual" and "Reference Manual" are available for this instrument.

- The User Manual is printed and delivered with the instrument.
- The electronic Reference Manual contains a full description of the instrument and its use.
- Keep both documents for future reference.
- Include both documents if you transfer the instrument to other parties.

Only use the instrument according to the User Manual and the Reference Manual. If you do not use the instrument according to these documents or if the instrument is modified, the safety of the instrument may be impaired and Mettler-Toledo GmbH assumes no liability.



User Manual and Reference Manual are available online.

See also

 Download the Reference Manual ▶ Page 9

2.1 Definitions of signal words and warning symbols

Safety notes contain important information on safety issues. Ignoring the safety notes may lead to personal injury, damage to the instrument, malfunctions and false results. Safety notes are marked with the following signal words and warning symbols:

Signal words

WARNING A hazardous situation with medium risk, possibly resulting in death or severe injury if not avoided.

CAUTION A hazardous situation with low risk, resulting in minor or moderate injury if not avoided.

NOTICE A hazardous situation with low risk, resulting in damage to the instrument, other material damage, malfunctions and erroneous results, or loss of data.

Warning symbols



General hazard: read the User Manual or the Reference Manual for information about the hazards and the resulting measures.



Hot surface



Notice

2.2 Product specific safety notes

Intended use

The refractometers Easy R40 and Easy Brix are designed to be used by trained staff. The refractometers are intended for measuring the refractive index and related values of liquid samples that are compatible with the materials with which they come into contact.

Any other type of use and operation beyond the limits of use stated by Mettler-Toledo GmbH without consent from Mettler-Toledo GmbH is considered as not intended.

Responsibilities of the instrument owner

The instrument owner is the person holding the legal title to the instrument and who uses the instrument or authorizes any person to use it, or the person who is deemed by law to be the operator of the instrument. The instrument owner is responsible for the safety of all users of the instrument and third parties.

METTLER TOLEDO assumes that the instrument owner trains users to safely use the instrument in their workplace and deal with potential hazards. METTLER TOLEDO assumes that the instrument owner provides the necessary protective gear.

Protective clothing



Gloves that protect your hands from contact with hot or cold surfaces.

Safety notes



WARNING

Death or serious injury due to electric shock

Contact with parts that carry a live current can lead to death or injury.

- 1 Only use the METTLER TOLEDO power supply cable and AC adapter designed for your instrument.
- 2 Connect the power cable to a grounded power outlet.
- 3 Keep all electrical cables and connections away from liquids and moisture.
- 4 Check the cables and the power plug for damage and replace damaged cables and power plugs.



CAUTION

Slight burns due to hot surface

The measuring cell can become hot enough to cause slight burns.

- 1 Do not touch the measuring cell without gloves before the measuring cell has cooled down.
- 2 Wear gloves that protect from contact heat if you need to touch the hot measuring cell.



NOTICE

Damage to the instrument due to the use of unsuitable parts

Using unsuitable parts with the instrument can damage the instrument or cause it to malfunction.

- Only use parts from METTLER TOLEDO that are intended to be used with your instrument.

See also

-  Technical data ▶ Page 25
-  Compliance information ▶ Page 26

3 Design and function

3.1 Overview refractometer

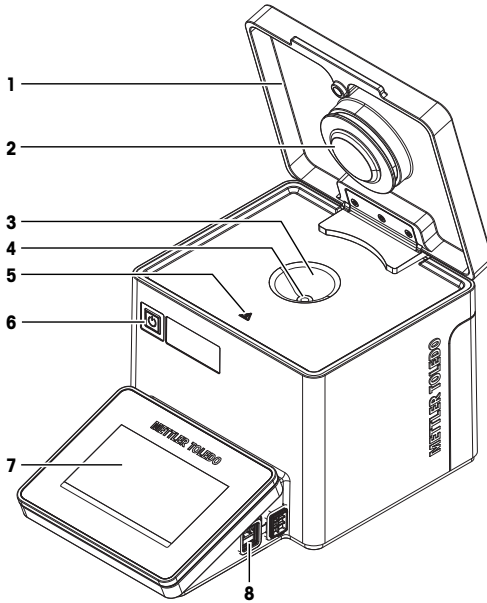

No.	Name	Function
1	Magnetic lid	Protects the measuring cell
2	Measuring-cell cover	Closes off the measuring cell and permits the formation of a stable vapor-liquid equilibrium
3	Measuring cell	Holds the sample
4	Prism	Refracts the light at its surface
5	Safety label	Warns that the measuring cell can be hot and cause slight burns if you touch it without protective gloves
6	Power button	The power button has the following functions: <ul style="list-style-type: none">• Start up the refractometer.• Shut down the refractometer.
7	Touch screen	Displays information and is used to enter information
8	USB-A socket	The USB-A socket has the following functions: <ul style="list-style-type: none">• Connection for USB devices, for example printers or barcode readers• Transfer of data to and from a USB flash drive

3.2 Rear panel

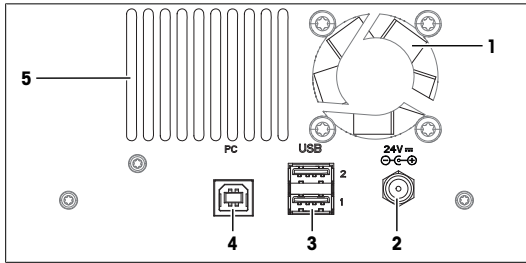

No.	Name	Function
1	Fan	Moves air over the heat sink of the Peltier element
2	24V	DC Socket to connect the AC adapter
3	USB1/USB2	USB-A socket <ul style="list-style-type: none"> • Connection for USB devices, for example printers or barcode readers • Transfer of data to and from a USB flash drive
4	PC	USB-B socket to connect a computer
5	Ventilation openings	Intake of air to cool the heat sink of the Peltier element

See also

Technical data ▶ Page 25

3.3 Overview of functions

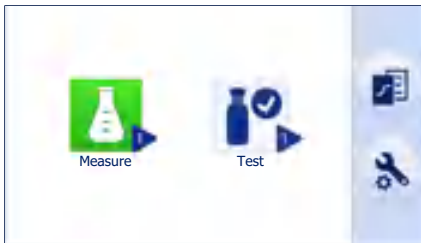

Icon	Name	Description
	Measure	Configure and start a Measure method to measure the refractive index or related values of a sample. <ul style="list-style-type: none"> • Easy Brix: one Measure method is available. • Easy R40: six Measure methods are available.
	Test	Configure and start a Test method to check the measurement accuracy with a standard substance. <ul style="list-style-type: none"> • Easy Brix: one Test method is available. • Easy R40: two Test methods are available.
	Results	Access and manage the results of the last 20 measurements, tests and adjustments.

Icon	Name	Description
	Setup & Tools	<p>Access the following functions:</p> <ul style="list-style-type: none"> • Settings: change instrument settings. • Language: change the language of the user interface. • Adjustment: configure and start an Adjustment method to adjust the measurement accuracy. • Diagnostics: run diagnostics. • Toolbox: Update the firmware, restore factory settings and factory adjustment and access service information.
–	LongClick™	<p>Tap and hold the icon of one of the following apps to start it directly from the home screen. ▶ shows which method is started.</p> <ul style="list-style-type: none"> • Measure • Test

3.4 Menu structure



Measure



Test



Results



Setup & Tools



Settings



Language



Adjustment



Diagnostics



Peripheral check



Printer check



Toolbox



Factory reset



FW Update



Adj. reset



MT-Service



Service history







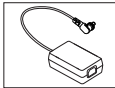

Settings

4 Installation and commissioning

4.1 Scope of delivery



Part	Order number	Easy R40	Easy Brix
 Refractometer	–	•	•

Part	Order number	Easy R40	Easy Brix
 AC adapter with power cable	30472916	•	•
 SimpleCheck nD Water Standard 1.333	30467245	•	•
 Plastic pipettes (3 pcs) 2 mL, PP (polypropylene)	–	•	•
 User Manual	–	•	•
 Test report	–	•	•
 Declaration of conformity	–	•	•
 Declaration of compliance with Chinese directive of restriction of hazardous substances	–	•	•

4.2 Download the Reference Manual

- 1 Go to the website
- 2 Select the **Technical Documentation** tab.
- 3 Enter the product type in the search field and start the search.
- 4 Select the Reference Manual from the result list.
- 5 Select the link.
⇒ The Reference Manual is either opened or downloaded depending on the browser settings.
- 6 Check which firmware version is installed on your refractometer.
- 7 If the Reference Manual is not written for the installed firmware version, contact your authorized METTLER TOLEDO service representative or dealer.

See also

-  Introduction ► Page 3
-  View the firmware version and other system information ► Page 25

4.3 Unpack the refractometer

- 1 Remove the refractometer from the protective packaging.
- 2 Store the packing material for later transport over long distances.
- 3 Check if you received all parts listed in the scope of delivery.
- 4 Inspect the parts visually for flaws or damage.

- 5 If parts are missing or damaged, report it to your authorized METTLER TOLEDO service representative or dealer.

4.4 Position the refractometer

The refractometer has been developed for indoor operation in a room with stable temperature and ventilation as needed by the chemicals that are used.

The following site requirements apply:

- Dew point below the measurement temperature
- Ambient conditions within the limits specified in the technical data
- No powerful vibrations
- No direct sunlight
- No corrosive gas atmosphere
- No explosive atmosphere
- No powerful electric or magnetic fields

Procedure

- 1 Place the refractometer on a level surface.
- 2 Make sure that there are at least 15 cm clearance behind the refractometer.
- 3 Make sure that nothing blocks the ventilation openings at the back of the refractometer.

See also

 Technical data ▶ Page 25

4.5 Connect the refractometer to the power supply

The AC adapter is suitable for all supply line voltages ranging from 100...240 V AC and 50/60 Hz.



WARNING

Death or serious injury due to electric shock

Contact with parts that carry a live current can lead to death or injury.

- 1 Only use the METTLER TOLEDO power supply cable and AC adapter designed for your instrument.
- 2 Connect the power cable to a grounded power outlet.
- 3 Keep all electrical cables and connections away from liquids and moisture.
- 4 Check the cables and the power plug for damage and replace damaged cables and power plugs.



NOTICE

Damage to the AC adapter due to overheating

If the AC adapter is covered or in a container, it is not sufficiently cooled and overheats.

- 1 Do not cover the AC adapter.
- 2 Do not put the AC adapter in a container.

Procedure

- 1 Install the cables in such a way that they cannot be damaged or interfere with operation.
- 2 Insert the plug of the power cable in the socket of the AC adapter.

- 3 Insert the plug of the AC adapter into the **24V** (1) socket on the rear panel.
- 4 Tighten the knurled nut to secure the plug.
- 5 Insert the plug of the power cable into a grounded power outlet that is easily accessible.

See also

- Start up the refractometer ▶ Page 11

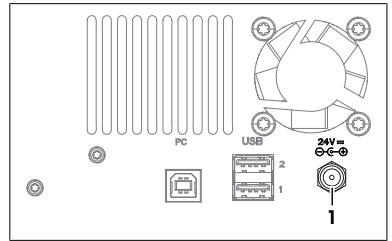

4.6 Disconnect the refractometer from the power supply

- The refractometer is shut down.
- 1 Pull the plug of the power cable out of the power outlet.
 - 2 Unscrew the knurled nut from the **24V** socket on the rear panel.
 - 3 Pull the plug of the AC adapter out of the **24V** socket on the rear panel.

See also

- Shut down the refractometer ▶ Page 12

4.7 Change the language

- 1 Go to > > .
- 2 Tap **Language** and select the language from the list.
 - ⇒ The selected language is used on the touch screen and printouts.
- 3 To return to **Setup & Tools**, tap .

4.8 Configure the refractometer

This chapter shows you how to access and change the following settings:

- Date and time
- Temperature unit
- Audio signal

Procedure

- 1 Go to > > > **Settings** (1).
- 2 Change the parameters as needed.
- 3 To view parameter descriptions, tap (2).
- 4 To return to **Setup & Tools**, tap (3).

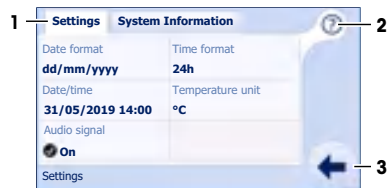

See also

- View parameter descriptions ▶ Page 12

5 Operation

5.1 Start up the refractometer

- The refractometer is connected to the power supply.
- 1 Press the power button (1) until the refractometer plays a beep.
 - ⇒ The welcome screen opens.
 - ⇒ The refractometer plays a beep and the home screen opens.

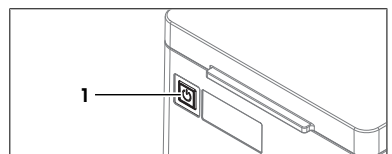

- Wait 15 minutes before you perform a measurement, if the instrument was stored or transported at temperatures that are significantly different from the ambient temperature at the place of installation.

5.2 Shut down the refractometer

Because the Peltier element is designed to keep the temperature of the measuring cell stable, the measuring cell takes time to adapt to a new temperature. METTLER TOLEDO recommends to only shut down the refractometer if it is not used for several days.

- No task is running.
 - The measuring cell is clean and dry.
- Press the power button (1).
 - ⇒ The refractometer shows the good-bye screen and ends running tasks.
 - ⇒ The refractometer plays three beeps and shuts down.
 - ⇒ The control circuit for the power button is energized. The rest of the refractometer is no longer energized.

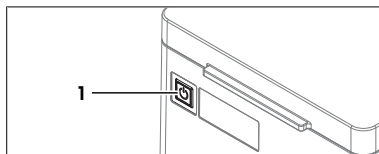

Shut down the refractometer in emergency situations

- Pull the plug of the power cable out of the power outlet.

5.3 View parameter descriptions

- A window with parameters is open.

- Tap  (1).



- Tap the parameter (2) that interests you.
 - ⇒ A window with the parameter description opens.
- Close the window.
- Tap  (1) to close the help.



5.4 Typical phases of a refractive-index determination

Refractive-index determinations usually include three phases.

- Fill the measuring cell and measure the refractive index.
- Rinse the measuring cell to remove residue of the sample.
- Dry the measuring cell.

5.4.1 Fill the measuring cell and measure the refractive index

METTLER TOLEDO recommends to use small sample volumes. For small volumes, the temperatures of the sample and the measuring cell equalize faster. Therefore the analysis takes less time.

- Aqueous samples: 0.5 mL
- Organic solvents: 1 mL

If you have samples that contain particles, it is important, that you always use the same sample volume.

The magnetic lid closes off the measuring cell. A closed measuring cell improves the results for the following reasons:

- The temperature of the sample and the temperature of the measuring cell equalize faster.
- A stable vapor-liquid equilibrium can form.

- The concentration of solutions remains constant, even if one component evaporates easily.

5.4.2 Rinse the measuring cell

At the end of this phase, the residue in the measuring cell must have the following properties.

- Evaporate without leaving incrustations.
- Evaporate easily.

To clean the measuring cell, it has to be rinsed with one or two different cleaning solutions.

- Purpose of the cleaning solution 1: Dissolve and remove the sample, so that the residue in the measuring cell is pure cleaning solution 1. If the cleaning solution 1 does not easily evaporate, a second cleaning solution must be used.
- Purpose of the cleaning solution 2: Dissolves the cleaning solution 1 and evaporates easily without leaving any residue.

METTLER TOLEDO recommends the cleaning solutions listed in the following table.

Sample	Cleaning solution 1	Cleaning solution 2
Water, water based	Deionized water	Measuring temperature <20 °C: acetone, ethanol (100 %) Measuring temperature ≥20 °C: none
Acids (concentrated)	Water (flush the measuring cell with plenty of water to remove the heat from the reaction of water and acid)	Measuring temperature <20 °C: acetone, ethanol (100 %) Measuring temperature ≥20 °C: none
Alkaline solutions (concentrated)	0.3...0.5 % deconex solution	Measuring temperature <20 °C: acetone, ethanol (100 %) Measuring temperature ≥20 °C: water
Samples with fats or oily components	0.3...0.5 % deconex solution	Measuring temperature <20 °C: acetone, ethanol (100 %) Measuring temperature ≥20 °C: water
Petrochemical samples, edible oils and fats	Toluene, xylene or petrol ether mixtures	Room temperature: low-boiling petrol ether mixture or acetone Temperature >30 °C: hexane or similar organic solvents

5.4.3 Dry the measuring cell

At the end of this phase, the measuring cell contains no residue and is ready for a new analysis or storage.

5.5 Example: Brix determination of apple juice



The following chapters show you how to configure a **Measure** method and determine the Brix value of apple juice at 20 °C.



You can find more information about the configuration of methods in the Reference Manual. **See** [Download the Reference Manual ▶ Page 9].

You can find parameter descriptions in the help embedded on the instrument. **See** [View parameter descriptions ▶ Page 12].

5.5.1 Configure the Measure method

- Go to  > .
 - ⇒ Easy R40: The parameter window of the last used **Measure** method (1) opens.
 - ⇒ Easy Brix: The parameter window of the **Measure** method opens.
- Change the parameter settings to the values shown in the following table.
- Use the arrows (2) to move between windows.



Parameter	Setting	Explanation
Temperature control	Yes	The refractometer keeps the temperature of the measuring cell at the temperature defined in Meas. temperature .
Meas. temperature	20.00 °C	The refractometer keeps the temperature of the measuring cell at 20 °C.
FastStart	Off	Users have to start the method manually.
Wait time	0 s	The refractometer starts to evaluate the stability of the measured value as soon as users press  .
Calculation category (Easy R40 only)	Sugar	A sugar concentration is calculated.
Calculation	Brix comp. 20 °C	A Brix value [% w/w] that is compensated to 20 °C is calculated.
Result limits	Yes	The refractometer evaluates if the result is within a defined range. <ul style="list-style-type: none"> • Results within limits: green writing • Results outside limits: red writing
Lower limit	11.3	The lower limit of the range is set to 11.3 % w/w.
Upper limit	11.7	The upper limit of the range is set to 11.7 % w/w.
Prompt for sample	Yes	The refractometer prompts users to add the sample.
Sample ID	Variable	The refractometer prompts users to enter the sample ID as soon as they have added the sample.
Clean	Yes	The refractometer prompts users to clean the measuring cell.
Printout	None	The result is not printed.
Export to USB (Easy R40 only)	No	The result is not exported.

5.5.2 Fill the measuring cell and measure the refractive index

Material

- Apple juice

- Plastic pipettes

Procedure

- The measuring cell is clean and dry.

1 Tap  (1).



⇒ You are prompted to add the sample (1).

- 2 Fill a clean plastic pipette with 0.5 mL of apple juice.
- 3 Open the magnetic lid.

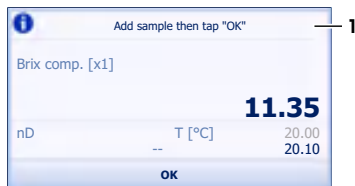

- 4 Place the pipette tip on the prism (1) and move it in circles over the prism while you empty it into the measuring cell.
- 5 Close the magnetic lid.

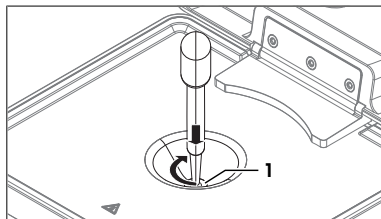

6 Tap **OK** (1).

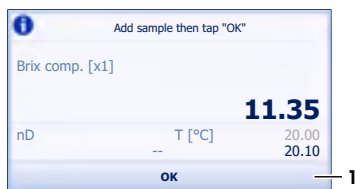

7 Enter the sample identification, using the **abc** key (1) to cycle between capital letters, small letters and numbers.

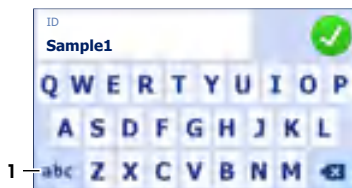

- 8 Tap .
- ⇒ The revolving circle (1) shows that the measurement is in process.
 - ⇒ The temperature of the measuring cell (4) is brought to the temperature defined in the method (3).
 - ⇒ The calculated Brix value (2) is displayed.



- ⇒ The result is saved and you are prompted to clean the measuring cell (1).



5.5.3 Clean the measuring cell

Material

- Deionized water
- Plastic pipettes
- Waste container
- Lint-free tissues

Drain the measuring cell

- 1 Open the magnetic lid.
- 2 Place the pipette tip on the prism (1) and aspirate the content of the measuring cell.
- 3 Empty the pipette into a suitable waste container.

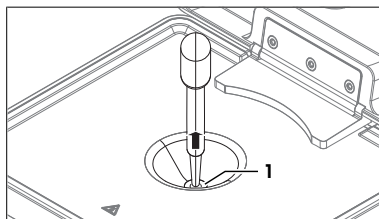

Rinse the measuring cell with deionized water

- 1 Fill a clean plastic pipette with deionized water.
- 2 Place the pipette tip on the prism (1) and move it in circles over the prism while you empty it into the measuring cell.

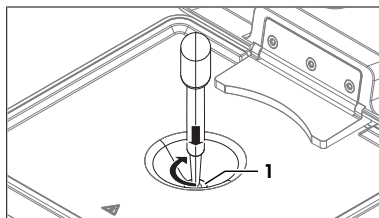

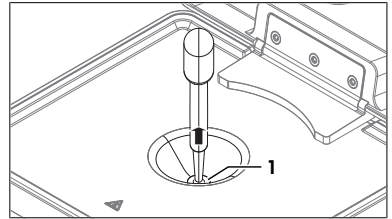

- 3 Place the pipette tip on the prism (1) and aspirate the content of the measuring cell.
- 4 Empty the pipette into a suitable waste container.
- 5 Repeat the previous steps two or three times.



Dry the measuring cell

- 1 Wipe the measuring cell with a dry, clean and lint-free tissue.
- 2 Wait a few seconds until any remaining residue of the deionized water has evaporated.
- 3 Close the magnetic lid.
- 4 Tap **OK** (1).



- 5 To restart the method, tap  (1).
- 6 To open the home screen, tap  (2).



6 Maintenance

In this chapter you find descriptions of the maintenance tasks you should perform on your refractometer. Any other maintenance tasks need to be performed by a service technician that has been qualified by METTLER TOLEDO.

If you experience problems with your refractometer, contact your authorized METTLER TOLEDO service representative or dealer.

METTLER TOLEDO recommends that your authorized METTLER TOLEDO service representative or dealer performs a preventive maintenance and calibration certification at least once a year.

► www.mt.com/contact

6.1 Maintenance schedule

If the standard operating procedures of your company require other maintenance intervals, use the intervals listed in the standard operating procedures.

Frequency	Task	Link
Daily	Clean the measuring cell at the end of the work day.	[Clean the measuring cell ► Page 18]
	Perform a Test method with a standard substance.	[Check the measurement accuracy ► Page 19]

6.2 Clean the measuring cell

6.2.1 Typical phases of cleaning the measuring cell

Cleaning the measuring cell usually includes two phases:

- Rinse the measuring cell to remove residue of the sample.
- Dry the measuring cell.

See also

- 📖 Rinse the measuring cell ▶ Page 13
- 📖 Dry the measuring cell ▶ Page 13

6.2.2 Example: clean using deionized water

Material

- Deionized water
- Plastic pipettes
- Waste container
- Lint-free tissues

Rinse the measuring cell with deionized water

- The measuring cell is drained.
- 1 Fill a clean plastic pipette with deionized water.
 - 2 Open the magnetic lid.
 - 3 Place the pipette tip on the prism (1) and move it in circles over the prism while you empty it into the measuring cell.
-
- 4 Place the pipette tip on the prism (1) and aspirate the content of the measuring cell.
 - 5 Empty the pipette into a suitable waste container.
 - 6 Repeat the previous steps two or three times.
 - 7 Dispose of the waste as required by the safety data sheet of the samples you use and the rules of your workplace.

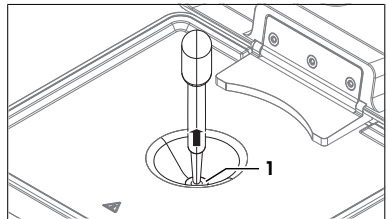
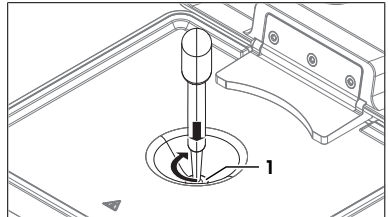

Dry the measuring cell



CAUTION

Slight burns due to hot surface

The measuring cell can become hot enough to cause slight burns.

- 1 Do not touch the measuring cell without gloves before the measuring cell has cooled down.
- 2 Wear gloves that protect from contact heat if you need to touch the hot measuring cell.

- 1 Wipe the measuring cell with a dry, clean and lint-free tissue.
- 2 Wait a few seconds until any remaining residue of the deionized water has evaporated.
- 3 Close the magnetic lid.

6.3 Check the measurement accuracy

6.3.1 Typical phases of checking the measurement accuracy

Checking the measurement accuracy usually includes three phases:

- Fill the measuring cell and measure the refractive index.
- Rinse the measuring cell to remove residue of the sample.
- Dry the measuring cell.

See also

- 📖 Fill the measuring cell and measure the refractive index ▶ Page 12
- 📖 Rinse the measuring cell ▶ Page 13
- 📖 Dry the measuring cell ▶ Page 13

6.3.2 Example: test with a SimpleCheck™ water-standard

The following chapters show you how to configure a **Test** method and determine the refractive index of a SimpleCheck water-standard at 20 °C.



You can find more information about the configuration of methods in the Reference Manual. **See** [Download the Reference Manual ▶ Page 9].

You can find parameter descriptions in the help embedded on the instrument. **See** [View parameter descriptions ▶ Page 12].

6.3.2.1 Configure the Test method

- Go to > .
 - ⇒ Easy R40: The parameter window for the last used **Test** method (1) opens.
 - ⇒ Easy Brix: The parameter window for the **Test** method opens.
- Change the parameter settings to the values shown in the following table.
- Use the arrows (2) to move between windows.

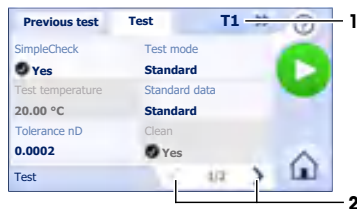

Parameter	Setting	Explanation
SimpleCheck	Yes	The workflow for self verification with SimpleCheck™ standard-substances is used.
Test mode	Standard	The refractometer determines a refractive index.
Test temperature	20.00 °C (read only)	The refractometer keeps the temperature of the measuring cell at 20 °C.
Standard data	–	Opens a window to enter standard data. Users are prompted to enter or scan the standard data when they start the test method.
Tolerance nD	0.0002	The result is marked as passed if it falls within the following range: nD nominal ± 0.0002
Clean	Yes (read only)	The refractometer prompts users to clean the measuring cell.
Printout	None	The result is not printed.

6.3.2.2 Fill the measuring cell and measure the refractive index

Material

- SimpleCheck water-standard
- Plastic pipettes

Start the method and configure the standard data

- The measuring cell is clean and dry.

1 Tap  (1).

⇒ The message **Make sure the cell is clean and dry. Do you want to continue?** opens.

2 Tap **Yes**.

⇒ The window with the standard data opens.

3 Enter the values declared on the certificate of the SimpleCheck water-standard manually or scan them with a barcode reader.

4 Tap .

⇒ You are prompted to add the SimpleCheck water-standard (1).

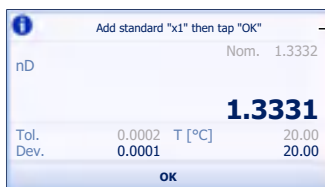
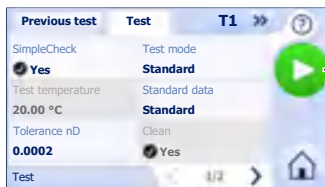

Fill the measuring cell and measure the refractive index

1 Open the magnetic lid.

2 Open the bottle with the SimpleCheck water-standard.

3 Discharge 4...5 drops of the SimpleCheck water-standard into a waste container to clear the nozzle.

4 Add 10...20 drops of the SimpleCheck water-standard to the measuring cell.

5 Close the bottle.

6 Close the magnetic lid.

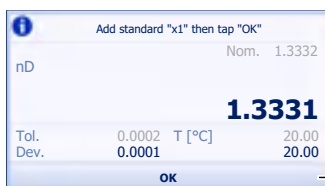
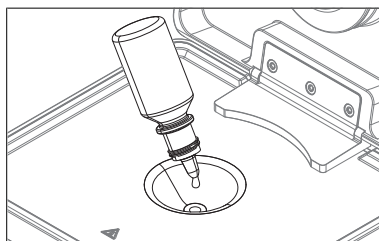

- 7 Tap **OK** (1).
 - ⇒ The revolving circle (1) shows that the measurement is in process.
 - ⇒ The temperature of the measuring cell (4) is brought to the temperature defined in the method (3).
 - ⇒ The refractive index (2) is displayed.

- ⇒ The result is saved and you are prompted to clean the measuring cell (1).



6.3.2.3 Clean the measuring cell

Material

- Plastic pipettes
- Waste container
- Lint-free tissues

Drain the measuring cell

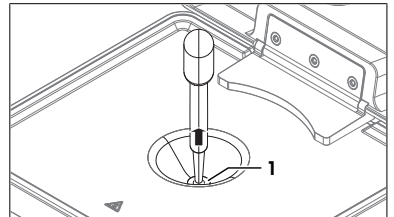

- 1 Open the magnetic lid.
- 2 Place the pipette tip on the prism (1) and aspirate the content of the measuring cell.
- 3 Empty the pipette into a suitable waste container.



Dry the measuring cell

- 1 Wipe the measuring cell with a dry, clean and lint-free tissue.
- 2 Wait a few seconds until any remaining residue of the deionized water has evaporated.
- 3 Close the magnetic lid.
- 4 Tap **OK** (1).



- 5 To restart the method, tap  (1).
- 6 To toggle between the result and the window with the measured value, tap (2).
- 7 To open the home screen, tap  (3).



6.3.3 Measures if the test fails

- 1 Check that you have used the correct standard substance, and if needed repeat the test with the correct standard substance.
- 2 If the test continues to fail, clean the measuring cell with a cleaning solution that dissolves your samples and dissolves in the standard substance.
- 3 Repeat the test.
- 4 If the test continues to fail, repeat the test twice and compare all three results.
- 5 If the results are not the same, clean the measuring cell and perform tests until the test passes or the results of three consecutive tests are the same.
- 6 If the test continues to fail and the results of three consecutive tests are the same, restore the factory adjustment data and repeat the test.
- 7 If the test continues to fail, perform an adjustment.

6.4 Clean the refractometer



NOTICE

Damage to the refractometer due to inappropriate cleaning methods

Inappropriate cleaning agents can damage the housing or other parts of the refractometer. If liquids enter the housing they can damage the refractometer.

- 1 Make sure the cleaning agent is compatible with the material of the part you want to clean.
- 2 Make sure that no liquid enters the interior of the refractometer.

If you have questions about the compatibility of cleaning agents, contact your authorized METTLER TOLEDO service representative or dealer.

See also

 Technical data ► Page 25

6.4.1 Clean the housing and the magnetic lid

METTLER TOLEDO recommends the following cleaning agents:

- Water
- Water with a mild detergent
- Ethanol

Procedure

- The refractometer is shut down and is disconnected from the power supply.
 - The measuring cell has cooled down to room temperature.
- 1 Open the magnetic lid.
 - 2 Wipe the housing with a cloth moistened with the cleaning agent.
 - 3 Wipe the inside and the outside of the magnetic lid with a cloth moistened with the cleaning agent.
 - 4 Wait until the magnetic lid and the space between the magnetic lid and the measuring-cell cover are dry.
 - 5 Close the magnetic lid.

6.5 Replace the magnetic lid

6.5.1 Remove the magnetic lid

- The refractometer is shut down and is disconnected from the power supply.
 - The measuring cell has cooled down to room temperature.
- 1 Open the magnetic lid.
 - 2 Hold the magnetic lid on both sides (1).

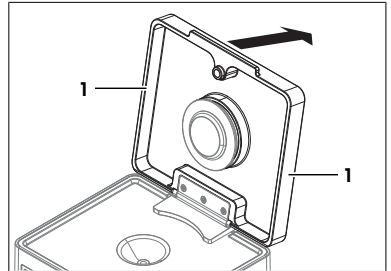

- 3 Push the magnetic lid (1) back with both hands until the magnets of the holding plate (2) detach from the protective plate (3).
- 4 Remove the magnetic lid.

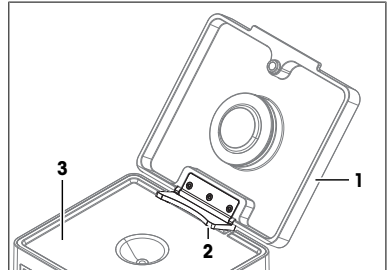

6.5.2 Install the magnetic lid

- 1 Align the rectangular opening (1) on the holding plate with the ridge (2).
- 2 Tilt the magnetic lid upward until the holding plate is attached to the protective plate.
- 3 Close the magnetic lid.

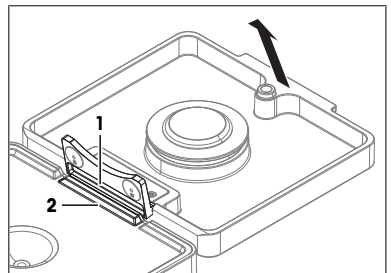

6.6 Replace the O-ring of the measuring-cell cover

6.6.1 Remove the O-ring

- 1 Remove the magnetic lid.

- 2 Insert the tip of a flat screwdriver (3) in the slit between the O-ring (2) and the measuring-cell cover (1).

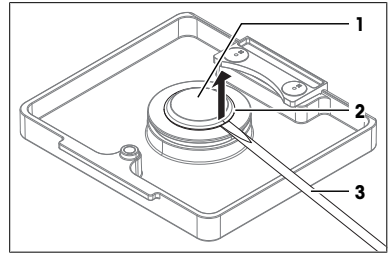

- 3 Use the screwdriver to lift the O-ring (1) over the rim of the groove.

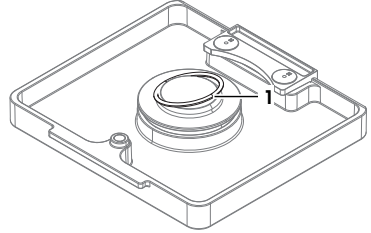

- 4 Lift the O-ring (1) completely out of the groove (2).

See also

- Remove the magnetic lid ▶ Page 23

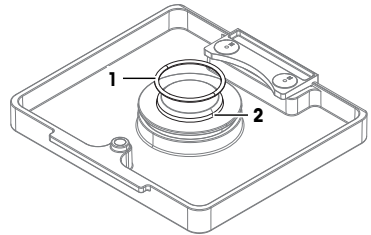

6.6.2 Install the O-ring

- 1 Place one side of the O-ring (1) in the groove (2) on the measuring-cell cover.

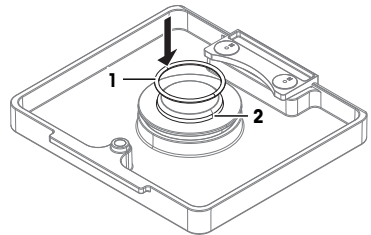

- 2 Push the other side of the O-ring (1) over the rim into the groove.

- 3 Install the magnetic lid.

See also

- Install the magnetic lid ▶ Page 23

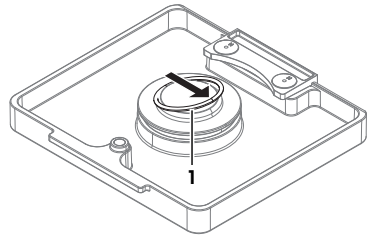

6.7 View the firmware version and other system information

- 1 Go to > > > **System Information** (1).
- 2 To view parameter descriptions, tap (2).
- 3 To move between windows, use the arrows (4).
- 4 To return to **Setup & Tools**, tap (3).

See also

- View parameter descriptions ▶ Page 12

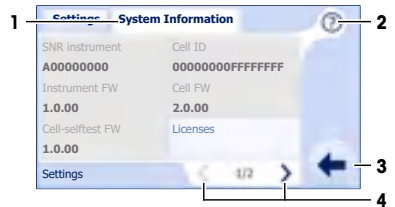

6.8 Prepare the refractometer for storage

- 1 Clean and dry the measuring cell.
- 2 Shut down the refractometer.
- 3 Disconnect the refractometer from the power supply.
- 4 Clean the refractometer.
- 5 Protect the refractometer from dust.
- 6 Store the refractometer in a dry and clean place.

See also

- Technical data ▶ Page 25

6.9 Transport the refractometer

If you have questions about transporting your refractometer, contact your authorized METTLER TOLEDO service representative or dealer.

- 1 Clean and dry the measuring cell.
- 2 Shut down the refractometer.
- 3 Disconnect the refractometer from the power supply.
- 4 Clean the refractometer.
- 5 If you transport the refractometer over long distances, use the packaging designed for the refractometer.
- 6 Move the refractometer to the new location.

6.10 Dispose of the refractometer

In conformance with the European Directive 2012/19/EU on Waste Electrical and Electronic Equipment (WEEE) this device may not be disposed of in domestic waste. This also applies to countries outside the EU, per their specific requirements.

Please dispose of this product in accordance with local regulations at the collecting point specified for electrical and electronic equipment. If you have any questions, please contact the responsible authority or the distributor from which you purchased this device. Should this device be passed on to other parties, the content of this regulation must also be related.



7 Technical data



Additional technical data are listed in the Reference Manual.

7.1 Refractometer

Characteristic	Value	
Power rating instrument	Input values	24 V DC, 2.5 A
	Socket	DC-Jack, 2.5 mm
Power rating AC adapter	Input voltage	100...240 V AC $\pm 10\%$, 1.5 A
	Input frequency	50/60 Hz
	Output values	24 V DC, 2.5 A
Dimensions	Width	200 mm
	Depth	280 mm
	Height	155 mm
	Weight	3.8 kg
Materials	Housing	Baydur (polyurethane)
	Touch screen	Gorillaz Glass 3
	Measuring cell	Sapphire prism, stainless steel (X2CrNiMo17-12-2 / 1.4404), PTFE (polytetrafluoroethylene)
Ambient conditions	Ambient temperature	+5 °C...+40 °C
	Relative humidity	20...80 % (not condensing)
	Altitude	≤ 5000 m above sea level
	Pressure	Atmospheric pressure
	Use	In interior spaces
	Overvoltage category	II
	Pollution degree	2
Storage conditions	Temperature	-20 °C...+70 °C
	Relative humidity	10...90 %

7.2 Measurement

Characteristic		Easy R40	Easy Brix
Refractive index	Measuring range	1.30...1.72	1.32...1.58
	Accuracy	± 0.0001	± 0.0001
	Repeatability	0.00005	0.00005
	Resolution	0.0001	0.0001
	Wavelength	589 nm	589 nm
Measuring temperature	Range ¹⁾	10...65 °C	15...25 °C
	Accuracy	± 0.1 °C	± 0.1 °C
	Resolution	0.01 °C	0.01 °C
Min. sample volume		0.2 mL	0.2 mL

¹⁾ Not more than 20 °C below ambient temperature

7.3 Compliance information

Application-relevant standards and norms are listed on the internet.

European Union

The instrument complies with the directives and standards listed on the EU Declaration of Conformity. SVHC candidate substances according to REACH (Article 33)

Material	CAS No.
1,2-dimethoxyethane	110-71-4

United States of America

This equipment has been tested and found to comply with the limits for a **Class A** digital device, pursuant to part 15 of the FCC Rules. These limits are designed to provide reasonable protection against harmful interference when the equipment is operated in a commercial environment. This equipment generates, uses, and can radiate radio frequency energy and, if not installed and used in accordance with the instruction manual, may cause harmful interference to radio communications. Operation of this equipment in a residential area is likely to cause harmful interference in which case the user will be required to correct the interference at his own expense.

Changes or modifications not expressly approved by the party responsible for compliance could void the user's authority to operate the equipment.

To protect your product's future:

METTLER TOLEDO Service assures the quality, measuring accuracy and preservation of value of this product for years to come.

Please request full details about our attractive terms of service.

Mettler-Toledo GmbH
Im Langacher 44
8606 Greifensee, Switzerland



30472430