



IncuSafe CO₂ & MULTIGAS INCUBATOR SERIES

Model Ranges:

MCO-50AIC Compact CO₂ Incubators
MCO-170AC CO₂ Incubators
MCO-170AIC CO₂ Incubators
MCO-230AIC CO₂ Incubators
MCO-80IC Reach In Incubator
MCO-50M Multigas Incubators
MCO-170M Multigas Incubators

Optimising cell culture outcomes and reproducibility. *IncuSafe* Incubators offer a precise and regulated environment. During cell culturing, the inCu-saFe germicidal interior and SafeCell UV lamp, work continuously to prevent contamination.



The complete line of PHC Europe B.V. products includes an array of laboratory equipment with the most advanced technology, controls, construction and performance attributes in the industry. Today we apply the most sophisticated refrigeration compressor design and state-of-the-art electronics to ultra-low and cryogenic freezers marketed to life science, pharmaceutical, biotechnology, healthcare and industrial laboratory markets.

PHCbi core technologies, patents, and intellectual properties are represented in every product line. Core technologies apply to critical components and processes such as compressors, microprocessor electronics, and patented VIP vacuum insulation panels. These are engineered to exact specifications for important applications in life science, pharmaceutical, biotechnology, clinical, and industrial laboratories. As a result, PHCbi products operate with dependability, safety, energy efficiency, and ergonomic sensitivity.

Your innovative partner for CO₂ and MULTIGAS INCUBATORS

Table of contents

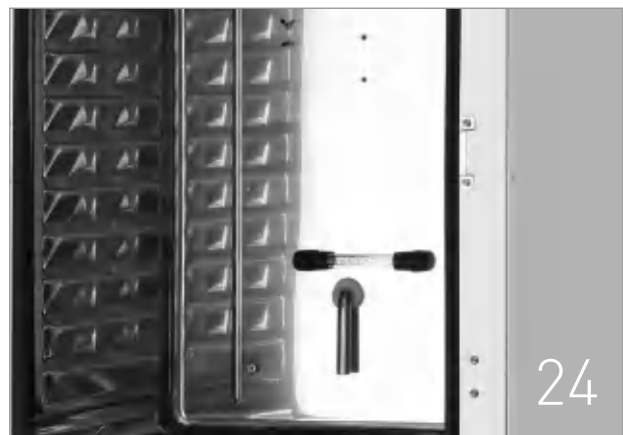

Commitment to quality	4
Incubator design by PHC	6
The IncuSafe advantage	7
IncuSafe CO ₂ incubators	12
IncuSafe Multigas incubators	18
Optional accessoires	19
Important points for installation	22
Basic care of cell culture incubators	24
Dimensions and Performance data	28
PrimeSurface cell culture plates	31

Committed to Quality

We at PHC Europe B.V. are committed to providing our customers with first class biomedical and pharmacy automation products and supporting services. Our goal is to maintain our market-leading reputation for excellent standards and for consistently living up to our customers' expectations.

Therefore, we are very proud to that PHC Europe B.V's quality management system is certified (by TÜV Nederland) to **ISO9001:2015**

We hold the certification that covers the sales, distribution, service and validation of biomedical and pharmacy-automation equipment covering our sites in Etten-Leur (Netherlands), Avon (France) and Loughborough (UK).



**Life Science
Innovator
Since 1966**

Quality - It's a word that all are familiar with and one which many manufacturers claim to have or strive for. In the view of PHC, quality is a term that is ultimately defined by the customer. When quality becomes a customer-driven concept, quality includes meeting or exceeding our customers' needs or expectations. We focus on total quality which includes advanced processes and the culture of our organization. The result of our total quality initiatives involve many steps to provide our customers with superior value.

10 steps to guarantee superior value

Understanding Customer Demands

Our vision of total quality involves many face-to-face visits to customers to directly hear what they have to say about using the equipment we have supplied.

Creating a New Product Concept

Developing a concept for a new product is very similar to the "basic research" processes in life sciences. Technical staff and engineers develop various basic and innovative technologies to realize the concept for a new product.

Creating a New Product Designs

As soon as engineering personnel begin developing a technological element, the design staff sets out to work on images.

Checking Local Legislation

We manufacture products for use in approximately 110 countries and regions around the world. Obviously, different laws and regulations apply, so we are always working to ensure our products conform to the laws and regulations of the individual locations

Design Review

Beyond determining specifications, evaluation criteria and achievement levels affecting product quality such as reliability, durability and safety standards must be achieved in mass-production models.

Founded in 1990 as subsidiary of the PHC Holdings Corporation, it is our mission to become a leading, trusted brand for sustainable healthcare and biomedical product solutions, which support the work of our customers to improve the health and well-being of people around the world.

For more than 30 years now, we respond to the needs of our pharmaceutical, biotechnology, hospital/clinical and industrial customers, offering an unique perspective on scientific research in general. As a result we play a critical role in product development for worldwide applications and have established a reputation as a manufacturer of high-quality and innovative medical and laboratory equipment.

Long lasting relationships have been built with leading pharmaceutical, healthcare and biotechnology companies as well as with major academic and research institutes in Europe. PHC Europe B.V. has set

the standard in many aspects. V.I.P. panels, Cool Safe compressors, Active Background Contamination Control and the world's first -152°C ULT freezer. Where PHC Europe B.V. took the initiative, the others followed. This made us a very important player in both the ultra-low temperature and the CO₂ market.

PHC Europe BV, part of the PHC Corporation, Biomedical Division, manages sales, marketing, logistics and technical service of PHCbi laboratory products throughout Europe (including Russia, Turkey, Middle East and Africa). Headquartered in the Netherlands with sales and service organizations in the UK, France and the Netherlands.

In the Dutch warehouse, about 1.000 units are waiting to be delivered directly from stock. Within a couple of days, spare parts can be delivered in every part of Europe. That's one of the strengths of PHC's European sales organization.



Quality Assurance

Under PHC standards, quality actions required in new product development must clear three hurdles: AQ-0 approval for design completion, AQ-1 decision for shifting to mass production and AQ-2 decision for shipping mass-produced units.

Mass Production

The Gunma factory was established in 1959 as the Tokyo manufacturing site for Sanyo Electric Co., Ltd. It is a core facility housing the Product Technology Development & Design Department, Quality Assurance Department and Production Department.

Transportation packaging design

Our product packaging is designed to fulfill various distribution challenges around the world. Using past accumulated lessons learned we focus on reducing and recycling materials to support environmental initiatives.

Installation

Product installations are often performed carefully by regional suppliers who are trained specialists. The path from facility entrance to the laboratory is measured and examined in advance to ensure precise, efficient installation. In some regions 'white glove' service is also available to aid in installation and set-up.

Sales and After-Sales Service

We always strive to learn more about our products. Before new products go into mass production at the factory, our sales personnel receives extensive knowledge about the products through intensive sales training

Incubator design by PHC

Providing a precisely controlled environment for sensitive cell cultures and delivering long-term performance, optimal cell viability and successful experiments, each PHCbi incubator provides precise control of CO₂ concentration and temperature, while remaining easy to operate and maintain. IncuSafe CO₂ Incubators support a reliable, stable cell culture environment across all shelf positions, meaning each and every cell is safely maintained under ideal conditions.

"Outstanding quality and performance for successful cell growth, optimal results and reproducibility. Perfect fit for the strictest and most sensitive protocols."

We have designed our incubators with ease of use and efficiency in mind. By delivering a user friendly cell culture incubator with rapid systems and processes, PHC can help make your work as simple as possible.



inCu-saFe germicidal interior
inCu-saFe germicidal interior prevents contamination.



SafeCell UV Lamp
The SafeCell UV lamp prevents contamination.



Dual IR CO₂ Sensor
The single beam, dual detector IR CO₂ Sensor offers continuous calibration for excellent control, accuracy and stability.



Direct Heat System
This system regulates temperature through three independent heating zones under microprocessor control.



Zirconia O₂ Sensor
The unique, solid state Zirconia O₂ sensor delivers precise oxygen control.



OLED alphanumeric Keypad
An OLED alphanumeric Keypad allows convenient but secure user control and display internal conditions.



Integrated Tray Catches
Significantly minimize cleaning time and improves productivity.



A full-color LCD Touch Panel
Various functions such as logging the temperature history, setting up passwords and alarms can be managed on the screen.



H₂O₂ Decontamination
The unique H₂O₂ decontamination system delivers fast and validatable decontamination.



Dual Heat Sterilisation
Dual heat sterilisation utilises the incubator's two heaters during the 180°C sterilisation process, which takes 11 hours. There is no effect on temperature inside stacked incubators due to low heat dissipation, cell culturing can continue uninterrupted.



Medical Device Directive
PHC has become one of the first companies in our industry to introduce Medical Device certification to underline our strong commitment to product design, quality and safety.

The **IncuSafe** Advantage

Optimising cell culture outcomes and reproducibility

Combining advanced technology, unique design features and high-quality engineering, IncuSafe Incubators offer the most precise and regulated environment for cell culture. Providing outstanding performance and flexibility, this innovative range of incubators enables you to optimise results and reproducibility. The IncuSafe Advantage is delivered through three important benefits:

A PRECISE & REGULATED ENVIRONMENT

IncuSafe Incubators offer accurate, uniform and highly responsive control of conditions within the chamber. Temperature is regulated through three independent heating zones under microprocessor P.I.D. control. High quality sensors within the incubators ensure excellent control of CO₂ and O₂.

STERILISATION TO MEET EVERY NEED

When additional sterilisation is required to complement background decontamination within the **IncuSafe** Incubators, PHC offers two sterilisation methods. For a fast turnaround, H₂O₂ decontamination safely cleans the chamber in less than three hours. Dual Heat Sterilisation (available in the MCO-170AICD-PE CO₂ Incubator) provides an 11-hour, 180°C sterilisation process. With extremely low heat dissipation during sterilisation, cell culturing can continue uninterrupted in stacked **IncuSafe** Incubators as the procedure is carried out.

ACTIVE BACKGROUND DECONTAMINATION

IncuSafe Incubators are designed to actively prevent contamination during cell culture. The unique, copper-enriched stainless steel alloy interior eliminates contamination and mitigates the effect of airborne contaminants that can be introduced through normal use. An optional, isolated, UV lamp decontaminates circulating air and water in the humidifying pan, without harming cultured cells.

Medical Device Directive



The MCO-170AIC-PE, MCO-170AICD-PE, MCO-230AIC-PE, MCO-170AC-PE, MCO-50M-PE and MCO-170M-PE are certified as a Class IIa Medical Device (93/42/EEC and 2007/47/EC).

Applicable countries: Austria, Belgium, Cyprus, Denmark, Finland, France, Germany, Ireland, Italy, Liechtenstein, Luxembourg, Malta, the Netherlands, Spain, Switzerland and the United Kingdom only

For laboratory use
Applicable countries: EEA countries, Switzerland and Turkey



IncuSafe CO₂ Incubators

IncuSafe CO₂ Incubators provide precise control of CO₂ concentration and accurate, uniform, and highly responsive temperature control within the chamber. During cell culturing, the inCu-saFe germicidal interior and SafeCell UV lamp, work continuously to prevent contamination. PHCbi offers two alternative sterilisation methods for the CO₂ Incubators to meet every need.

TEMPERATURE CONTROL

Direct Heat system



The Direct Heat system regulates temperature through three independent heating zones under microprocessor P.I.D* control. The system anticipates the amount of energy needed to recover chamber temperature for fast recovery times.

*Proportional Integral Derivative

Internal conditions

- To avoid cell culture desiccation, IncuSafe CO₂ and Multigas Incubators maintain 95% RH at 37°C.
- Humidification is achieved by reliable natural evaporation and gentle air circulation.



Heat zones

- Side, top and rear walls form the dominant radiant heat source.
- The bottom heater elevates the humidity reservoir water temperature to achieve 95% RH at 37°C.
- The outer door heater warms the inner glass door to prevent condensation on the glass and to assure interior temperature

PRECISE & REGULATED ENVIRONMENT: INSULATION

AIR JACKET SYSTEM

Precise and uniform temperature control is ensured by the Air Jacket system. The jacket itself is surrounded by high-density foam insulation to protect against ambient temperature fluctuations, eliminating 'cold-spots' and preventing condensation. Uniform temperatures are further ensured by gentle fan circulation within the chamber.*

* In MCO-170AIC, MCO-230AIC & MCO-170M series

MELAMINE FOAM

The MCO-170AICD-PE has melamine foam insulation, which provides high thermal insulation and excellent heat endurance. Melamine foam insulation limits heat dissipation during dry heat sterilisation. This means that cell culture can continue uninterrupted in incubators stacked with those actively running sterilisation.

CO₂ CONTROL

Dual IR CO₂ Sensor



The incubator's Dual IR sensor and P.I.D control enables ultra-fast CO₂ recovery without overshoot, even following multiple door-openings. The single beam, dual detector IR CO₂

Sensor offers continuous calibration for excellent control, accuracy and stability.

The sensor simultaneously measures sample and reference wavelengths for continuous auto-zero calibration. The ceramic-based sensor is unaffected by moderate changes in temperature and relative humidity and is linked to the P.I.D. controller for fast recovery times.

The IR sensor measures the absorbance of light from an infrared lamp of a specific wavelength over a fixed distance. As only CO₂ absorbs light at the selected wavelength, the sensor functions independently of both temperature and humidity.

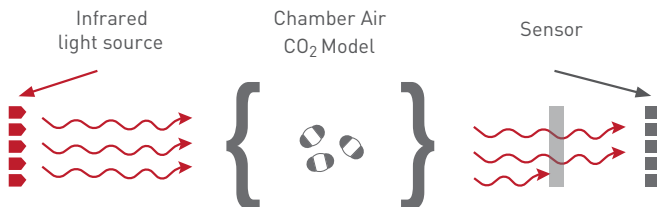

If CO₂ levels are low, a high number of IR rays pass through.

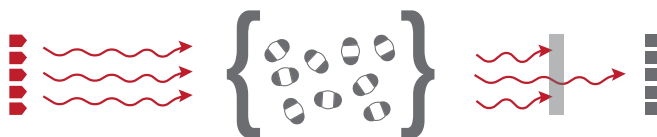

If CO₂ levels are high, a lower number of IR rays pass through.

CONDENSATION MANAGEMENT

The unique condensation management "dew stick" controlled by Peltier technology condenses water vapour on its surface, which then drips into the humidifying pan, preventing unwanted condensation in the chamber and possible contamination.

HORIZONTAL LAMINAR AIRFLOW SYSTEM ON MCO- 80IC

The MCO-80IC features a cross-shelf horizontal airflow system, which promotes optimum temperature and CO₂ uniformity throughout the incubator and contributes to rapid recovery after door openings. The conditioned air is directed evenly through the incubator using perforated wall plenums made from PHCbi's exclusive inCu-saFe[®] copper-enriched stainless steel. The horizontal airflow helps to maintain uniform air circulation and even temperature distribution when samples are placed in the incubator.

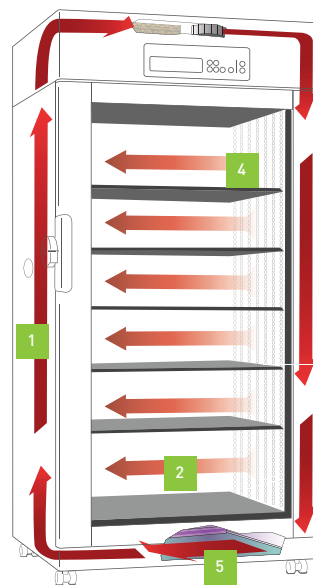

1. Access ports (each side, 40mm).
2. Horizontal laminar airflow system maintains accurate temperature and CO₂ control and uniformity at all shelf levels, top-to-bottom, front-to-back.
3. Humidified air minimizes potential for cell culture media desiccation.
4. Perforated sidewall panels right (pressure) and left (negative pressure) assure a positive, gentle airflow from right to left.
5. Optional SafeCell[®] UV sterilisation system provides sterilisation of the humidity reservoir.

CO₂ CONTROL - FASTER RECOVERY & LOWER GAS CONSUMPTION

PHCbi's large scale cell culture incubator has been designed specifically for critical applications in pharmaceutical, biotechnology and clinical investigation. Large chamber capacity applications require special consideration of gas usage and recovery times. PHCbi's proprietary IR sensor with P.I.D. CO₂ control algorithm is paramount to the industry's leading design. An optional inner door system (MCO-80ID-PW) is also available to enhance these results further.

ACTIVE BACKGROUND DECONTAMINATION

IncuSafe Incubators are designed to actively prevent contamination during cell culture. The unique, copper- enriched stainless steel alloy interior eliminates contamination and mitigates the effect of airborne contaminants that can be introduced through normal use. An optional, isolated, UV lamp decontaminates circulating air and water in the humidifying pan, without harming cultured cells.

inCu-saFe



inCu-saFe germicidal interior prevents contamination. The exclusive inCu-saFe copper-enriched stainless steel alloy interior offers the germicidal properties of copper and the durability of stainless steel.

Selected to provide passive germicidal protection without rust or corrosion, inCu-saFe expresses a natural germicidal effect, inhibiting the growth of molds, fungi, mycoplasma and bacteria on its surface continuously.

All interior components, including the air management plenum, humidity pan and fan assembly are easily removable without tools if required. When components are removed, all interior surfaces are exposed for conventional wipe down.



The chart below demonstrates the germicidal properties of **IncuSafe** copper enriched stainless steel alloy against four strains of mycoplasma.

MYCOPLASMA STRAIN	NEGATIVE CONTROL	CONVENTIONAL TYPE 304 STAINLESS STEEL	InCu-SaFe INTERIOR	CONVENTIONAL COPPC1100
Mycoplasma Fermentans PG18	no growth	growth	no growth	no growth
Mycoplasma Orale CH19299	no growth	growth	no growth	no growth
Mycoplasma Arginini G230	no growth	growth	no growth	no growth
Mycoplasma Hominis PG21	no growth	growth	no growth	no growth

Experimental conditions

1. Mycoplasma suspension(105-106/ml) is dropped on the test piece.
2. Incubate at 37 °C, 5% CO₂ for 24 hours.

3. Re-suspend in fresh medium.

4. Incubate at 37 °C, for 7 days.
5. If the Mycoplasma survives, the medium will change to a specific colour.

INCUSAFE INTERIOR COMBINES THE BENEFITS OF COPPER AND STAINLESS STEEL

- Fights off surface contamination.
- Does not corrode like solid copper surfaces.
- Appearance and durability of stainless steel.
- Standard feature in all IncuSafe CO₂ & Multigas Incubators.

COMPETING INCUBATOR WITH COPPER INTERIORS

- May corrode over time.
- Humid environment may cause interior coating to turn into green cupric oxide, which may prove to be lethal to cell cultures.
- Contamination is difficult to detect due to discoloration of interior surfaces.
- Difficult to maintain and clean.

SafeCell UV Lamp



The programmable ultraviolet lamp, isolated from cell cultures, eliminates contaminants in the air-flow and water-pan without affecting cell cultures. SafeCell UV inhibits the growth of mycoplasma, bacteria, molds, spores, yeasts and fungi without costly HEPA filters that accumulate contaminants in the chamber air. Interior air motion is suspended when the door is opened, minimising movement of room air contaminants into the chamber.

- Ozone-free UV lamp
- UV shielded from culture area by the tray cover of humidifying pan.



VERSATILE PROGRAM CYCLES OF SAFECELL UV LIGHT FOR OPTIMUM USABILITY

24 Hour UV Decontamination

This feature can be used in the following instances:

- Prior to 1st use
- Overnight
- Between patient protocols
- Following maintenance or service
- Secondary decontamination method

After Door Openings

Door closure causes UV lamp to turn ON for 10 minutes decontaminating the external air that entered the chamber.

After H₂O₂ Vapourization

The UV lamp automatically cycles ON for up to 90 minutes following a 10-minute H₂O₂ vapour cycle. This reduces the H₂O₂ to water, which condenses onto a cooler section of the incubator's interior floor for easy clean-up.

ON/OFF

If UV protection is not desired the SafeCell UV lamp can be switched OFF.

AIRFLOW & WATER PAN DECONTAMINATION USING A UV SYSTEM

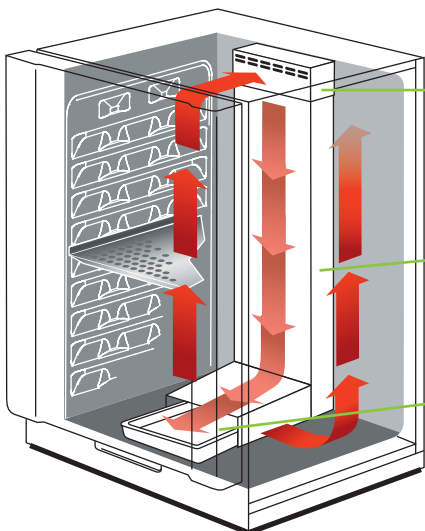

Airflow Decontamination

Humidified, decontaminated air is released from the lower plenum for vertical convection through and around the perforated shelves.

UV Light

Ultraviolet light is contained behind an enclosed structure to direct rays at water pan and airflow, away from cultured cells.

Humidifying pan

Contaminants trapped in the water pan are destroyed by high intensity, ozone-free ultraviolet light.

STERILISATION METHODS

When additional sterilisation is required to complement background decontamination within the **IncuSafe** Incubators, PHC offers two sterilisation methods. For a fast turnaround, H_2O_2 decontamination safely cleans the chamber in less than three hours. Dual Heat Sterilisation (available in the MCO-170AICD-PE CO_2 Incubator) provides an 11-hour, $180^\circ C$ sterilisation process. With extremely low heat dissipation during sterilisation, cell culturing can continue uninterrupted in stacked **IncuSafe** Incubators as the procedure is carried out.

H_2O_2 Decontamination Technology



The unique H_2O_2 decontamination system delivers fast and validatable decontamination.

The high-speed decontamination system uses vaporised hydrogen peroxide and UV light. It cleans the chamber of the incubator safely in less than three hours, achieving a minimal 6 log reduction of major contaminants.

MCO-170AICUVH-PE / MCO-230AICUVH-PE / MCO-170MUVH-PE
MCO-50AIC-PE (optional) / MCO-50M-PE (optional)

HOW DOES IT WORK?

1. Hydrogen peroxide (aqueous) is converted to vapour using high frequency ultrasonics. During this process, the fan motor remains active, ensuring H_2O_2 vapour accesses every point of the chamber and the tubing to and from, and the inside of the CO_2 sensor.
2. The H_2O_2 vapour breaks down into hydroxyl radicals naturally.
3. The hydroxyl radicals initiate a chain reaction of electron stealing.
4. This unstable internal environment leads to death of contaminants. Remaining hydroxyl radicals and H_2O_2 are resolved to H_2O (aqueous) & O_2 (gas).

H_2O_2 Decontamination

H_2O_2 Decontamination

High Heat Decontamination



VS



STEP 1 Preparation Time: 10 - 15 minutes

STEP 2 Decontamination Time: Approx. 135 minutes

STEP 3 Finish Time: Approx. 10 minutes

Approx. 160 minutes

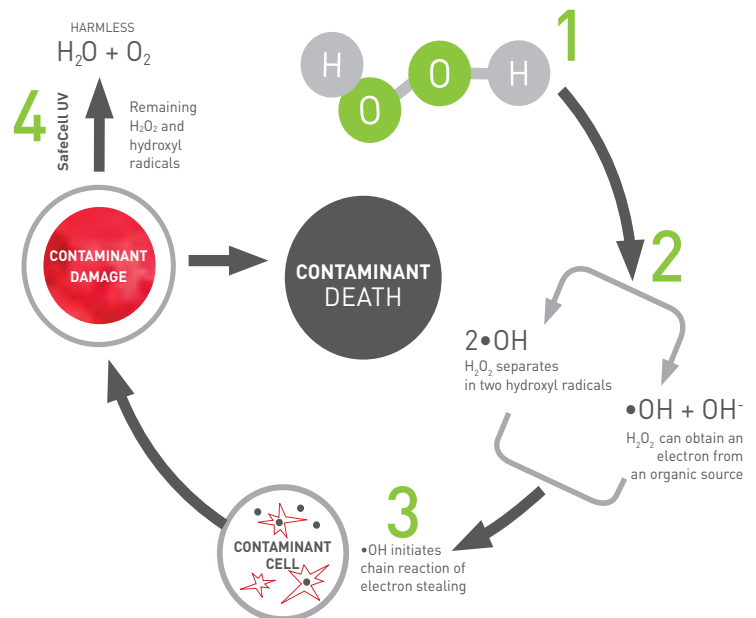

DNA is very susceptible to oxidative damage. Since most bacteria have a single chromosome controlling all their life functions, this kind of effect can be detrimental to their normal function. Prokaryotic organisms often lack repair mechanisms to limit such damage, making them more prone to change.

Dual Heat Sterilisation



Dual heat sterilisation utilises the incubator's two heaters during the 180°C sterilisation process, which takes 11 hours. There is no effect on temperature inside stacked incubators

due to low heat dissipation, so cell culturing can continue uninterrupted. There is no need to remove inner parts such as the CO₂ sensor and UV light, or recalibrate after sterilisation, therefore, laboratory processes are more efficient with less incubator downtime.

MCO-170AICD-PE / MCO-170AICUVD-PE

Dual Heat Sterilisation



STEP 1 Preparation Time: 10 - 15 minutes

STEP 2 Sterilisation time: approx. 11 hours

STEP 3 Finish Time: Approx. 10 minutes

Approx. 685 minutes

MCO-170AICD STERILISATION CYCLE

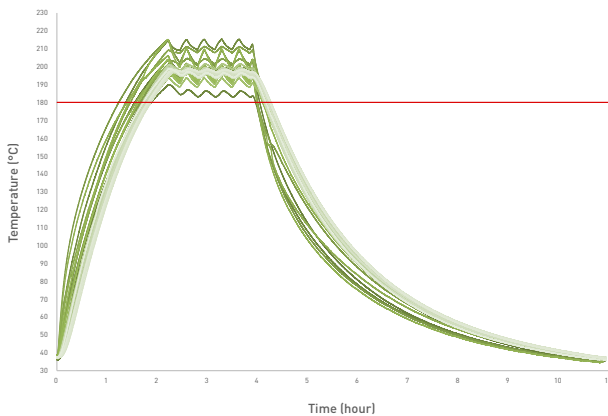

A 35-point temperature mapping shows that the MCO-170AICD achieves far beyond 180°C in all areas of the chamber.

The dry heat sterilisation cycle is controlled through the incubator microprocessor control system. The total process time required is 11 hours. The outer door is locked automatically upon initiation of the sterilisation cycle and unlocked upon completion.

DUAL HEAT STERILISATION COMPETITOR COMPARISON

	Day 1	Day 2	Day 3
Competitor A	Remove inner parts Dry heat sterilisation 12HR	Attach inner parts Recalibrate temperature and CO ₂ density	Restart incubation
Competitor B	Remove inner parts Dry heat sterilisation 12HR	Attach inner parts Automatically calibrate temperature and CO ₂ density	Restart incubation
MCO-170AIC(UVD)	Dry heat sterilisation 11HR	Restart incubation	



INCREASE IN CLEANING AND STORAGE EFFICIENCY WITH INTEGRATED SHELF SUPPORTS

The MCO-50, MCO-170 and MCO-230 series employ an integrated tray structure without shelf supports, reducing the number of interior components by approximately 80%* and significantly saving cleaning time needed when changing cells for incubation. Save valuable time and reduce the risk of contamination with an easy to clean incubator interior featuring fully rounded corners and integrated shelf supports.

For basic care of cell culture incubators see page 24. For more detailed decontamination and cleaning instructions please download our Incubation cleaning brochure from our website.

In a laboratory environment it is important to make the most of all the space available. With integrated shelf supports the **IncuSafe** incubators provide space for up to 25% more culture vessels.*

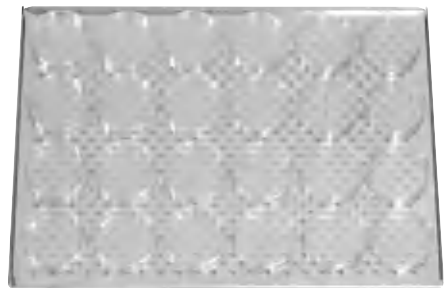

MCO-230AIC Series, 24 petri plates (90 mm dishes)



MCO 50 series Series, 10 petri plates (90 mm dishes)

Interior components of MCO-170AIC

Traditional Incubator

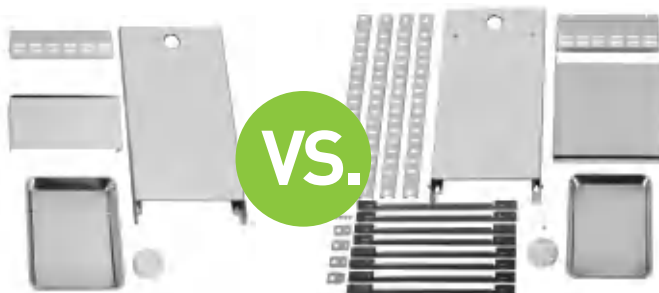

5

26

INTEGRATED SHELF SUPPORTS AND REVERSIBLE & SEPARATE INNER DOORS



ELECTRIC LOCK OPTION

Automatic door lock with password protection is available as a standard feature for the several models and can be easily set up. Other models are compatible with the optional electric door lock (MCO-170EL).

STACKABLE COMBINATIONS

All PHCbi incubators are designed for stacking, allowing one unit to be positioned on top of another, doubling interior volume without additional floor space. An optional roller base is available for single and stacked installations for easier mobility.

HEAT STERILISATION IN STACKED INCUBATORS

To prevent burning during the heat sterilisation cycle, the outer door is electronically locked. The top surface temperature of the MCO-170AICD during heat sterilisation is approximately 60°C. 60°C is within the tolerance described in the International Safety Standard IEC61010 10.1 Surface temperature limits for the burn prevention.

Both chambers can be in use at the same time even when double stacked.

no heat leakage



For the combination table see page 19



ADVANCED TOUCH PANEL ON MCO-170AIC-PE AND MCO 230 SERIES

A color LCD touch panel delivers full control over the incubator. Control can be performed with gloved hands.

Control and visibility of the internal conditions, such as CO₂ level and temperature, is easy with the MCO-170AIC CO₂ incubator.



OLED KEYPAD ON MCO-170AC-PE AND MCO 50 SERIES

An OLED alphanumeric keypad allows convenient but secure user control. It can display internal conditions, such as CO₂ level, temperature and alarms. Transfer of data is easy via an USB port.

Adjustable audible and visual alarms are standard, along with integrated system diagnostics and predictive performance supervision. The passwordprotected control panel provides security and minimizes risk of accidental changes in setpoint.



NEW MULTI-USER LOCK ACCESS (MCO-230AIC & MCO-170M SERIES ONLY)

Now available with user ID function that allows registration of up to 99 user-IDs and passwords through a master user account for better control and traceability. Detailed activity logs can be exported easily as individual CSV files.

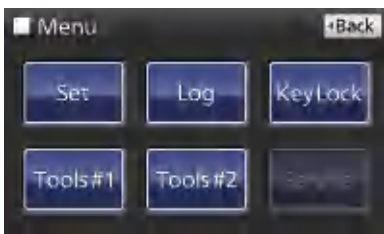

Menu Screen

The Menu Screen allows for alarm settings, data logs and all other incubator settings.



Graphical Display

The system allows for viewing the logs of the actual temperature, CO₂ levels and the door openings of the chamber.



USB PORT

Optimise cell culture protocols and adhere to standard operating procedures by conveniently transferring data to a USB memory stick to pass on to a PC. Logged parameters include chamber temperature, CO₂ level, O₂ level, door open status and alarms.



MCO-170AIC-PE series
165L

optional: DIRECT HEAT system, inCu saFe, IR dual sensor, MDD medical device directive, H₂O₂ decontamination, SafeCell UV, TOUCH control panel, Integrated heater



MCO-170AICD-PE series
165L

optional: DIRECT HEAT system, inCu saFe, IR dual sensor, MDD medical device directive, DUAL HEAT sterilisation, SafeCell UV, TOUCH control panel, Integrated heater



MCO-230AIC-PE series
230L

optional: DIRECT HEAT system, inCu saFe, IR dual sensor, MDD medical device directive, H₂O₂ decontamination, SafeCell UV, TOUCH control panel, Integrated heater

IncuSafe CO₂ Incubators

Model Number		MCO-170AIC-PE / MCO-170AICUV-PE MCO-170AICUVH-PE	MCO-170AICD-PE MCO-170AICUVD-PE	MCO-230AIC-PE / MCO-230AICUV-PE MCO-230AICUVH-PE
External Dimensions (W x D x H)	mm	620 x 730 x 900		770 x 730 x 905
Internal Dimensions (W x D x H)	mm	490 x 523 x 665		643 x 523 x 700
Volume	litres	165		230
Net Weight	kg	80		90
Temperature Control Range	°C	AT +5 ~ +50, ±0.1		AT +5 ~ +50, ±0.1
Temperature Uniformity	°C	±0.25		±0.25
CO ₂ Control Range & Fluctuation	%	0 ~ 20, ±0.15		0 ~ 20, ±0.15
Humidity Level & Fluctuation	%RH	95, ±5		95, ±5
Sterilisation Method		H ₂ O ₂ Decontamination	Dry heat sterilisation, 180°C	H ₂ O ₂ Decontamination



MCO-50AIC-PE
50L

optional: DIRECT HEAT system, inCu saFe, IR dual sensor, H₂O₂ decontamination, SafeCell UV, TOUCH control panel, Integrated heater, OLED control panel

MDD
medical device directive

Medical device
The MCO-50AIC-PE is in conformity as a Class I Medical Device.
Applicable countries: Austria, Belgium, Cyprus, Denmark, Finland, France, Germany, Ireland, Italy, Liechtenstein, Luxembourg, Malta, the Netherlands, Spain, Switzerland and the United Kingdom only

Research device
Applicable countries: EEA countries, Switzerland and Turkey



MCO-170AC-PE
165L

optional: inCu saFe, OLED control panel, Integrated heater, SafeCell UV, MDD medical device directive



MCO-80IC-PE
851L

optional: inCu saFe, IR dual sensor, SafeCell UV

IncuSafe CO₂ Incubators

Model Number		MCO-50AIC-PE	MCO-170AC-PE	MCO-80IC-PE
External Dimensions (W x D x H)	mm	480 x 550 x 585	620 x 730 x 905	986 x 853 x 2040
Internal Dimensions (W x D x H)	mm	370 x 363 x 385	490 x 523 x 665	806 x 693 x 1524
Volume	litres	50	165	851
Net Weight	kg	46	74	275
Temperature Control Range	°C	AT +5 ~ +50, ±0.1 °C	AT +5 ~ +50, ±0.1 °C	AT +5 ~ +50, ±0.1
Temperature Uniformity	°C	±0.25	±0.25	±0.5
CO ₂ Control Range & Fluctuation	%	0 ~ 20, ±0.15 %	0 ~ 20, ±0.15 %	0 ~ 20, ±0.15
Humidity Level & Fluctuation	%RH	95, ±5	95, ±5	Normal mode; >80 High mode; > 90

IncuSafe Multigas Incubators

Tightly controlled physiological oxygen environment with time-saving decontamination and improved usability. IncuSafe multigas incubators optimize mammalian cell cultures through variable O₂ control to simulate *in vivo* conditions for regenerative medicine and stem cell applications. The MCO-170M-PE and MCO-50M-PE help to achieve more accurate results when culturing cells at physiological oxygen levels.

ZIRCONIA O₂ SENSOR



Reaching a correct level of O₂ requires a sensor capable of reading O₂ levels directly to assure accuracy and precise environmental control. The unique, solid state Zirconia O₂ sensor delivers precise oxygen control. The sensor maintains long-term high accuracy, while offering a long life-span, and no need for periodic calibration.

The more O₂ passes through the Zirconia sensor, the more electrical current is induced. This creates a signal to inject more N₂ molecules to displace O₂ molecules.

Conversion of O₂ concentration to electrical current

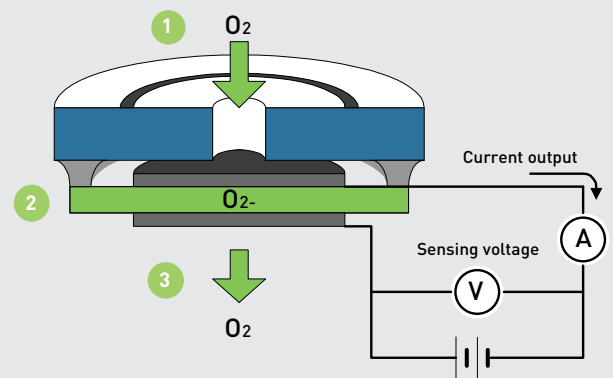

1. Diffusion of O₂ molecules across Zirconia sensor
2. Cathode produces electrical current as O₂ passes
3. O₂ reacts with Zirconia to produce ions

DIRECT
HEAT
system

inCu
saFe

iR
dual sensor

zirconia
O₂
control

MDD
medical device
directive

H₂O₂
decontamination

SafeCell
UV

optional



MCO-50M-PE
50L

DIRECT
HEAT
system

inCu
saFe

iR
dual sensor

zirconia
O₂
control

MDD
medical device
directive

H₂O₂
decontamination

SafeCell
UV

optional



MCO-170M-PE series
165L

IncuSafe Multigas Incubators			
Model Number	MCO-50M-PE		MCO-170M-PE / MCO-170MUV-PE / MCO-170MUVH-PE
External Dimensions (W x D x H)	mm	480 x 550 x 585	620 x 730 x 900
Internal Dimensions (W x D x H)	mm	370 x 363 x 385	490 x 523 x 665
Volume	litres	50	161
Net Weight	kg	46	77
Temperature Control Range	°C	AT +5 ~ +50, ±0.1 °C	AT +5 ~ +50, ±0.1
CO ₂ Control Range & Fluctuation	%	0 to 20, ±0.15	0 to 20
O ₂ Control Range	%	1 to 18%, 22 to 80%, ±0.2	1 to 18%, 22 to 80%, ±0.2
Humidity Level & Fluctuation	%RH	95, ±5	95, ±5
Sterilisation Method		H ₂ O ₂ Decontamination	H ₂ O ₂ Decontamination

Optional accessories

- All PHCbi incubators are designed for stacking, allowing one unit to be positioned on top of another, doubling interior volume without additional floor space.
- An optional roller base is available for single and stacked installations for easier mobility.



Stacking kits

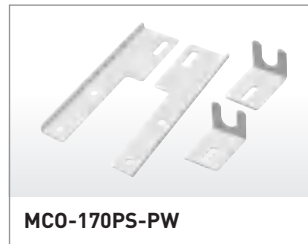

Double-Stacking Matching Table (MCO-50 series can be Triple Stacked)

SPACER FOR DOUBLE-STACKING		UPPER UNIT		
LOWER UNIT		MCO-170 series	MCO-230AIC-PE	MCO-50 series
	MCO-170 series	MCO-170PS-PW	N/A	MCO-170PS-PW
	MCO-230AIC-PE	MCO-230SB-PW	MCO-170PS-PW	MCO-170PS-PW
	MCO-19AIC-PE	MCO-170SB-PW	N/A	MCO-170SB-PW
	MCO-18AC/18AIC-PE	MCO-170SB-PW	N/A	MCO-170SB-PW
	MCO-20AIC-PE	MCO-170SB-PW	MCO-230SB-PW	MCO-170SB-PW
	MCO-50 series	N/A	N/A	MCO-170PS-PW
MCO-5 series	N/A	N/A	MCO-50SB-PW	

Roller Bases



Roller bottle rack mount



Trays



Reinforced trays



Tray options

description	MCO-170-PE series	MCO-230-PE series	MCO-50-PE series	MCO-80IC-PE
Tray (same as standard accessory)	MCO-170ST-PW	MCO-230ST-PW	MCO-50ST-PW	MCO-80ST-PW
Reinforced Tray	MCO-170RT-PW	MCO-230RT-PW	-	-
Half tray	MCO-25ST-PW	MCO-35ST-PW	-	-

Multiple inner doors



H₂O₂ option for 170 and 230 series

H₂O₂ decon board
MCO-170HB-PE



H₂O₂ generator
MCO-HP-PW



H₂O₂ reagent
MCO-H202-PE



CO₂ incubators 170 series

Model Number	MCO-170AIC-PE	MCO-170AICUV-PE	MCO-170AICUVH-PE	MCO-170AICD-PE	MCO-170AICUVD-PE
SafeCell UV [®] System	MCO-170UVS-PE	Standard	Standard	MCO-170UVSD-PE	Standard
H ₂ O ₂ Decontamination Board	MCO-170HB-PE	MCO-170HB-PE	Standard	-	-
Electric Door Lock with Password	MCO-170EL-PW	MCO-170EL-PW	Standard	Standard	Standard
H ₂ O ₂ Vapour Generator		MCO-HP-PW			-
H ₂ O ₂ Reagent, pack of 6 bottles		MCO-H202-PE			-
Multiple Inner Doors		MCO-170ID-PW			N/A
CO ₂ Gas Pressure Regulator		MCO-100L-PW			MCO-100L-PW
Automatic CO ₂ Cylinder Changeover System		MCO-21GC-PW			MCO-21GC-PW
Semi-automatic one point Gas Calibration Kit		MCO-SG-PW			MCO-SG-PW
InCu-saFe [®] Shelf		MCO-170ST-PW			MCO-170ST-PW
InCu-saFe [®] Half Tray System		MCO-25ST-PW			MCO-25ST-PW
Double Stacking Bracket*		MCO-170PS-PW			MCO-170PS-PW
Stacking Plate*		MCO-170SB-PW			MCO-170SB-PW
Roller Base		MCO-170RB-PW			MCO-170RB-PW
Optional communication systems					
Analogue interface (4-20mA)				MCO-420MA-PW	

CO₂ incubators 230 series

Model Number	MCO-230AIC-PE	MCO-230AICUV-PE	MCO-230AICUVH-PE
SafeCell UV [®] System	MCO-170UVS-PE	Standard	Standard
H ₂ O ₂ Decontamination Board	MCO-170HB-PE	MCO-170HB-PE	Standard
Electric Door Lock with Password	MCO-170EL-PW	MCO-170EL-PW	Standard
H ₂ O ₂ Vapour Generator		MCO-HP-PW ⁶¹	
H ₂ O ₂ Reagent, pack of 6 bottles		MCO-H202-PE	
CO ₂ Gas Pressure Regulator		MCO-100L-PW	
Automatic CO ₂ Cylinder Changeover System		MCO-21GC-PW	
Semi-automatic one point Gas Calibration Kit		MCO-SG-PW	
InCu-saFe [®] Shelf		MCO-230ST-PW	
InCu-saFe [®] Half Tray System		MCO-35ST-PW	
Double Stacking Bracket*		MCO-170PS-PW	
Stacking Plate*		MCO-230SB-PW	
Roller Base		MCO-230RB-PW	
Optional communication systems			
Analogue interface (4-20mA)	MCO-420MA-PW		

Gas auto changer

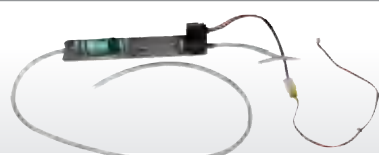

MCO-21GC-PW [for MCO-170 series and MCO-230 series]

MCO-50GC-PW
[for MCO-50 series]

MCO-80GC-PW
[for MCO-80IC]

Gas regulator



MCO-010R-PW
[except for MCO-80IC]

STD gas auto calibration kit

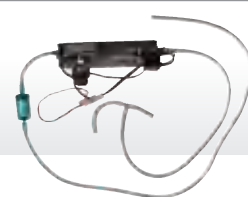

MCO-SG-PW
[for MCO-170 series and MCO-230 series]

UV system set

MCO-170UVS-PE



MCO-19UVS-PE



MCO-80UVS-PE



CO₂ incubators

Model Number	MCO-50AIC Series	MCO-170AC-PE	MCO-80IC-PE
SafeCell UV [®] System	MCO-170UVS-PE	MCO-010R-PW	MCO-80UVS-PE
H ₂ O ₂ Decontamination Board	MCO-50HB-PW	-	-
H ₂ O ₂ Vapour Generator	MCO-50HP-PW	-	-
H ₂ O ₂ Reagent, pack of 6 bottles	MCO-5H2O2-PE	-	-
Electric Door Lock with Password	MCO-170EL-PW	-	-
Multiple Inner Doors	-	MCO-170ID-PW	MCO-80ID-PW (5 small doors)
CO ₂ Gas Pressure Regulator	MCO-010R-PW	MCO-010R-PW	MCO-100L-PW
N ₂ Gas Pressure Regulator	MCO-010R-PW	-	MCO-80GC-PW
Automatic CO ₂ Cylinder Changeover System	MCO-50GC-PW	MCO-21GC-PWS	-
Semi-automatic one point Gas Calibration Kit	-	-	MCO-80ST-PW
InCu-saFe [®] Shelf	MCO-50ST-PW	MCO-170ST-PW	-
InCu-saFe [®] Half Tray System	-	MCO-25ST-PW	-
Double Stacking Bracket*	MCO-170PS-PW	MCO-170PS-PW	-
Stacking Plate*	MCO-50SB-PW	MCO-170SB-PW	-
Roller Base	MCO-50RB-PW	MCO-170RB-PW	-
Roller bottle rack mounting kit	-	-	MCO-80RBS-PW
Automatic water supply system kit	-	-	MCO-80AS-PW
Optional communication systems			
Analogue interface (4-20mA)		MCO-420MA-PW	

Multigas incubators

Model Number	MCO-50M-series	MCO-170M-PE	MCO-170MUV-PE	MCO-170MUVH-PE
SafeCell UV [®] System	MCO-170UVS-PE	MCO-170UVS-PE	Standard	Standard
H ₂ O ₂ Decontamination Board	MCO-50HB-PW	MCO-170HB-PE	MCO-170HB-PE	Standard
H ₂ O ₂ Vapour Generator	MCO-50HP-PW		MCO-HP-PW ⁶⁾	
H ₂ O ₂ Reagent, pack of 6 bottles	MCO-5H2O2-PE		MCO-H2O2-PE	
Electric Door Lock with Password	MCO-170EL-PW	MCO-170EL-PW	MCO-170EL-PW	Standard
Multiple Inner Doors	-		Standard	
CO ₂ Gas Pressure Regulator	MCO-010R-PW		MCO-100L-PW	
N ₂ Gas Pressure Regulator	MCO-010R-PW		MCO-100L-PW	
Automatic CO ₂ Cylinder Changeover System	MCO-50GC-PW		MCO-21GC-PW	
Semi-automatic one point Gas Calibration Kit	MCO-50SB-PW		MCO-SG-PW	
InCu-saFe [®] Shelf	MCO-50ST-PW		MCO-170ST-PW	
InCu-saFe [®] Half Tray System	-		MCO-25ST-PW	
Double Stacking Bracket*	MCO-170PS-PW		MCO-170PS-PW	
Stacking Plate*	MCO-50SB-PW		MCO-170SB-PW	
Roller Base	MCO-50RB-PW		MCO-170RB-PW	
Optional communication systems				
Analogue interface (4-20mA)			MCO-420MA-PW	

Important points for installation

There are many factors to consider when determining the permanent location of the cell culture incubator. It is desirable to locate the unit where there is minimal foot traffic and where air disturbance is of little consequence. This reduces the volatility of outside air entering the incubator during a door opening. Avoid installing the incubator near windows, air conditioners, ceiling or floor HVAC air diffusers and return air intakes, all of which are sources of airborne contamination.

INSTALLATION, LOCATION AND CLEARANCES

It is important to consider the function of the biological safety cabinet when planning for incubator contamination mitigation.

If feasible, locate the incubator as close to the biological safety cabinet (BSC) as possible. This limits the exposure when removing or replacing cell cultures for processing.

Improper use of the BSC, wrong sash window height, blockage of downflow slots and use of instrumentation or equipment on the BSC work surface can create pathways for contaminants to attach to the cell culture labware when working in the hood. These contaminants are then returned to the incubator where they can migrate to other cultures via cross contamination or to interior surfaces exposed to a conditioned atmosphere ideal for cell growth. While BSCs are usually equipped with HEPA filters designed to trap particulates of 0.3 microns (0.12 microns for ULPA filters), smaller viruses can easily pass through these barriers. Although the cell culture lab may normally be under positive pressure, this can change to neutral or even negative pressure when a BSC is operating, especially when the BSC has an exhaust transition connected to or over the exhaust filter.

Other laboratory equipment such as centrifuges, stirrers, shakers and robotic plate readers can aggravate an otherwise calm air environment to create aerosols that are easily airborne.

It is important to establish clearances adjacent to and behind the incubator because this space is required to provide easy access to gas supply tubing, tubing filters, gas input ports, pass-thru ports and blanking plugs and any interior components such as blower motors, fans or sensors that must be removed for maintenance.

Most CO₂ cylinders, for example, contain an industrial grade CO₂ supply in liquid form wherein the CO₂ gas evaporates and moves through the two-stage pressure regulator as a gas. It exits the regulator at a pressure of approximately 20 PSIG, sufficient to prevent the introduction of contaminants into the gas system. The CO₂ itself, however, often contains microscopic particles that may provide surfaces for contaminants. Thus, it is recommended that the final CO₂ supply tubing be fitted with a 0.3-micron HEPA filter prior to passage into the incubator.



Locations where there is a lot of foot traffic are not suitable for the unit.

- Locate the incubator in a clean room or location where few people enter
- Choose a clean room that is safe or a place where there are as few people as possible.

Set up the unit as high off the floor as possible

- Since there are fewer airborne bacteria in the upper part of a room, the incubator should be placed on a laboratory table or a special stand.
- If stacking two or three units on top of each other, use a special roller base for that purpose.

Place in a location that is not directly affected by outside air

- Avoid putting the unit in a location that will be directly affected by air from a window, door, or air conditioning/ heating vent.



Basic care of cell culture incubators

Always puts on gloves before cleaning the unit.
As a basic rule, do not clean the incubator with bare hands. Be sure to use rubber gloves.

Necessary materials

- Rubber gloves
- 70% ethanol
- Sterile non-woven cloth/paper

STEP 1

Turn off the power



STEP 2

Remove the interior components.

Remove the components in the correct order.

- 1 Remove the shelves
- 2 Remove the humidifying tray cover, and take out the tray
- 3 Remove the back duct
- 4 Remove the fan
- 5 Remove the stopper for the access port

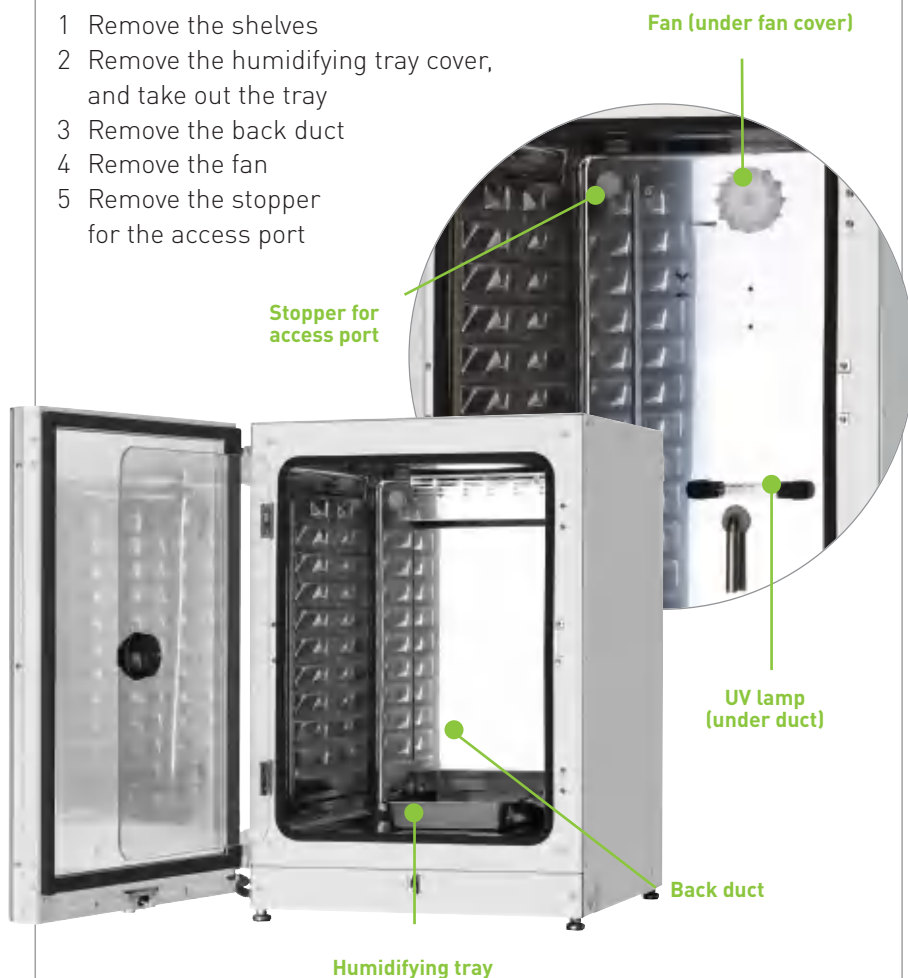

STEP 3

Clean the interior components

Use the correct cleaning procedure.

- 1 Wash with a neutral detergent (soap)
- 2 Rinse well with distilled water
- 3 Wipe with sterile non-woven cloth/paper



STEP 4

Spray disinfecting alcohol inside the unit and wipe (70% ethanol).

Do not spray 70% ethanol into the sensor holes directly! Just wipe off with non-woven cloth/paper which is sprayed with 70% ethanol.



STEP 5

Disinfect all interior surfaces, internal components, shelves and water tray with 70% ethanol.

STEP 6

Please make sure to spread the ethanol for disinfection to all corners of the inner door gasket and sufficiently remove stains while wiping it clean.

If it is operated with the inner door gasket not in place, the humidified air will leak and will cause condensation between the unit and outer door. After wiping, confirm that the inner door gasket is securely in place and doesn't have any creases.

Adjust shape of inner door gasket after wiping

Adjust the shape of inner door gasket by sliding fingers from each corner in direction of arrows. Specifically, insert fingers behind fin of inner door gasket and slide.

The inner door gasket has an important role to maintain the chamber humidity. If it is operated with the inner door gasket not in place, the humidified air will leak and will cause condensation between the unit and outer door. After wiping, confirm that the inner door gasket is securely in place and doesn't have any creases. If the inner door gasket is not in place, please refer to the back side and adjust the shape of the inner door gasket.



STEP 7

Replace the interior components.

Replace the components in the reverse order of [STEP 2], and put sterilized distilled water in the humidifying tray.

- 1 Replace the stopper for the access port
- 2 Replace the fan, check to see if the fan spins smoothly by turning it with your hand
- 3 Replace the back duct
- 4 Replace the humidifying tray cover, and put in the tray
- 5 Replace the shelves



STEP 8

Let it dry with the door ajar.

Before turning the power back on (restarting) let the inside dry out, check that there is no alcohol smell remaining. If you turn the power on while it is still damp inside, the O₂ and CO₂ sensors may be damaged.



STEP 9

If using a unit that is equipped with dual heat sterilisation function or H₂O₂ (hydrogen peroxide) decontamination function, performing sterilisation/decontamination before use will make prevention of contamination (bacterial contamination) more effective.



IncuSafe CO₂ Incubator with dual heat sterilisation:

MCO-170AICD-series

IncuSafe CO₂ Incubator with H₂O₂ decontamination:

MCO-170AICUVH, MCO-230AICUVH

MCO-50AICUVH, MCO-50MUVH

MCO-170MUVH



CLEANING PRECAUTION

Get into the habit of wiping carefully

- Be sure to wear gloves to avoid cutting your hands on the interior component
- Do not use acid, alkali, or chlorine-based cleaners, disinfectants, or sanitizers

IMPORTANT POINT

Do not wipe with the same portion of the sterile non-woven cloth more than once.

If you wipe another area with same portion of the cloth, you will be spreading bacteria around. Don't forget to wipe the gasket and the inside of the door.



CLEANING THE HUMIDIFYING WATER

When replacing the water, also clean the tray. Do this at least once every two weeks.

- Remove the tray from the unit
- Wash it in neutral detergent before wiping it
- Spray it with 70% ethanol, and then wipe
- Fill the humidifying tray with sterile distilled water (preferably pre-heated to 37°C)

IMPORTANT POINT

Do not use ultrapure water, tap water, deionized water or reverse osmosis water as these are not suitable for incubators.

Please avoid adding any chemicals to the humidifying tray.



Dimensions of cell culture incubators

IncuSafe CO₂ and Multigas Incubators

MCO-170AIC and MCO-170M SERIES

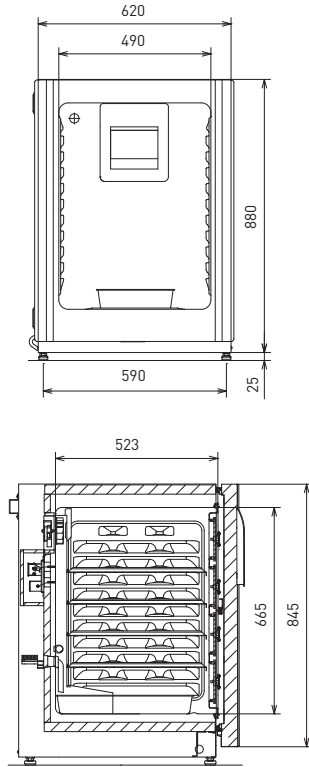

MCO-230AIC SERIES

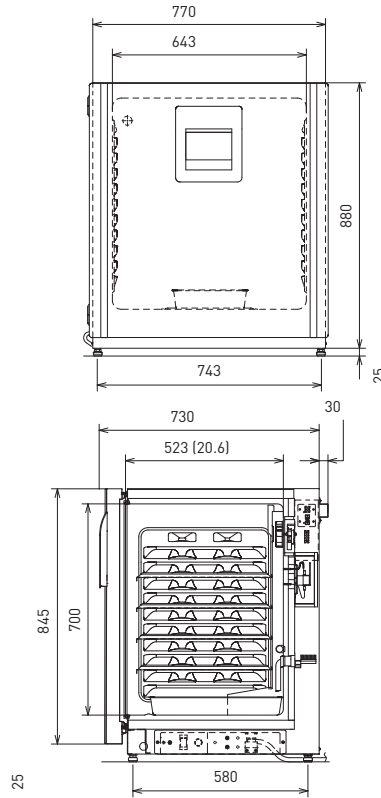

MCO-170AC SERIES

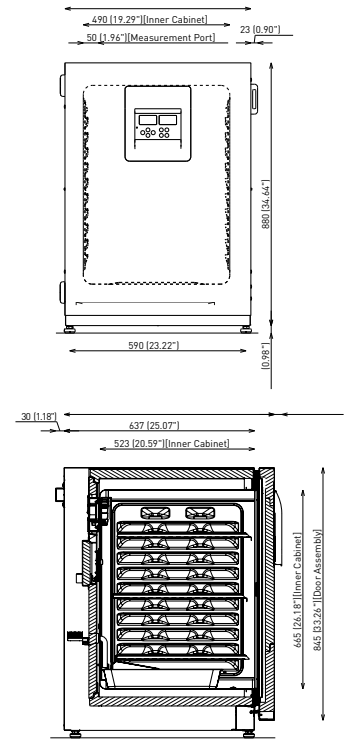

MCO-50AIC and MCO-50M SERIES

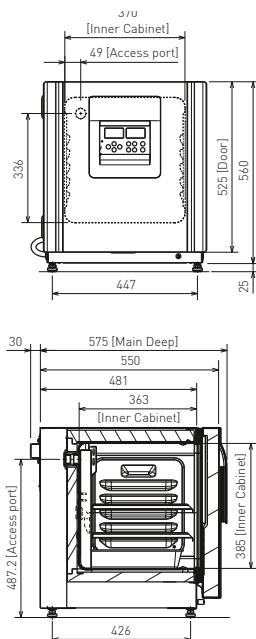

MCO-80IC-PE

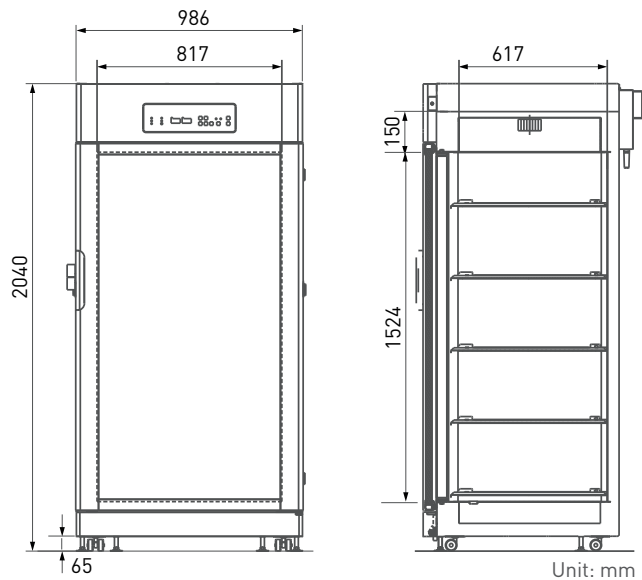

Unit: mm

Performance data of cell culture incubators

IncuSafe CO₂ Incubators

MCO-170AIC SERIES

MCO-230AIC SERIES

MCO-170AIC-PE

Temperature recovery

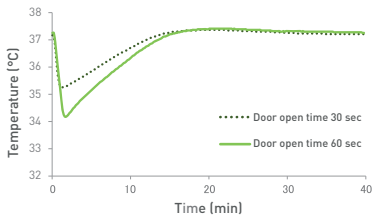

CO₂ density recovery

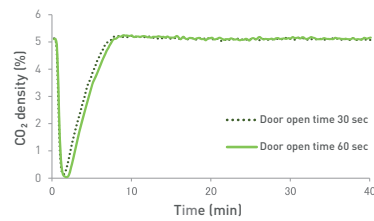

Humidity recovery

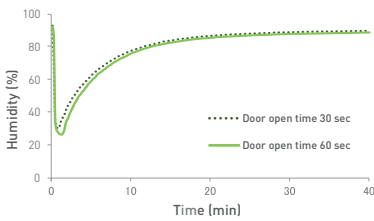

MCO-170AICD-PE

Temperature recovery

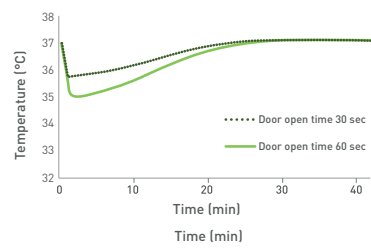

CO₂ density recovery

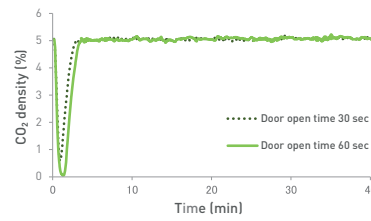

Humidity recovery

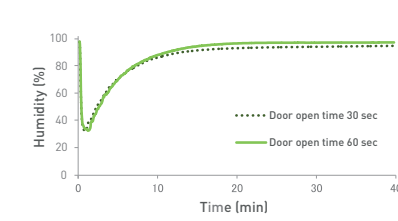

MCO-230AIC-PE

Temperature recovery

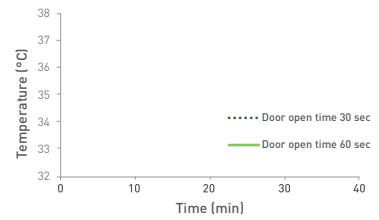

CO₂ density recovery

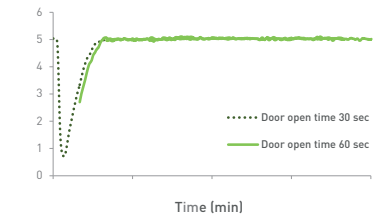

Humidity recovery

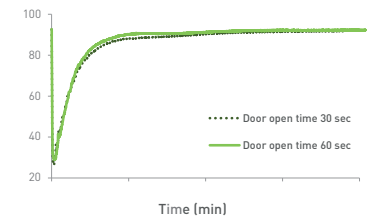

MCO-80IC-PE

MCO-80IC-PE

Temperature level recovery characteristics

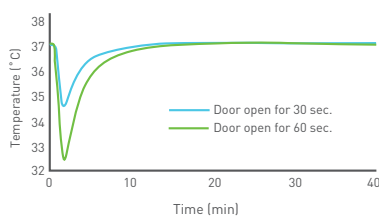

CO₂ level recovery characteristics

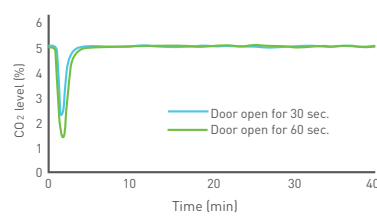

MCO-170AC SERIES

MCO-50 SERIES

MCO-170M SERIES

MCO-170AC-PE

Temperature pull-up characteristics

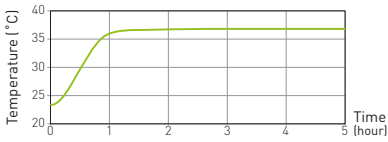

Temperature recovery characteristics

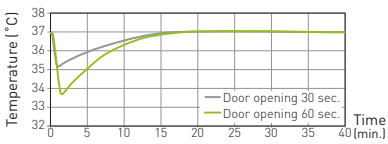

Humidity recovery characteristics

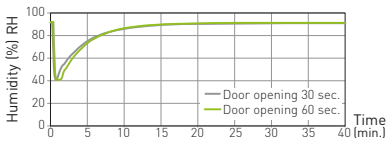

CO₂ level recovery characteristics

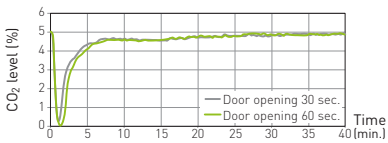

Temperature pull-down/pull-up characteristics (50AIC(L) / 50M)

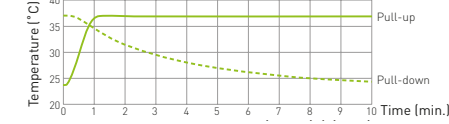

Temperature recovery characteristics (50AIC(L) / 50M)

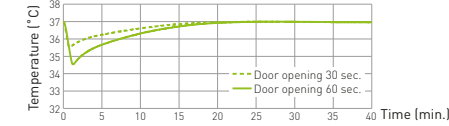

Humidity recovery characteristics (50AIC(L))

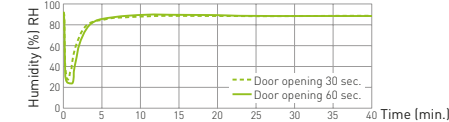

Humidity recovery characteristics (50M)

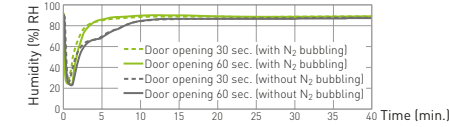

CO₂ level recovery characteristics (50AIC(L) / 50M)

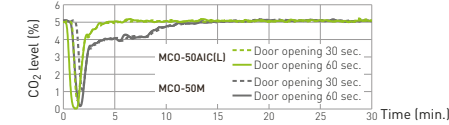

O₂ level recovery characteristics (50M)

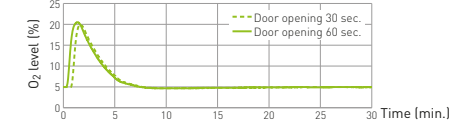

* MCO-50AIC(L) Ambient temperature: 23°C, setting: 37°C, CO₂: 5 %, no load
 * MCO-50M Ambient temperature: 23°C, setting: 37°C, CO₂: 5 %, O₂: 5 %, no load

MCO-170M-PE

Temperature recovery

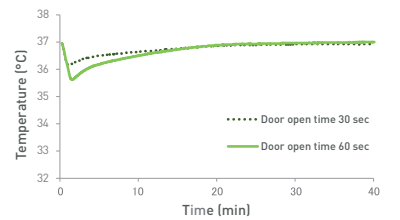

CO₂ density recovery

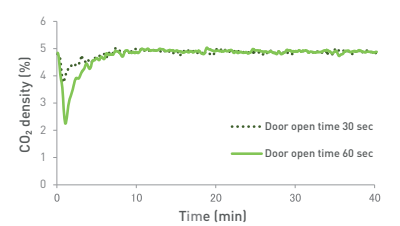

Humidity/CO₂ recovery

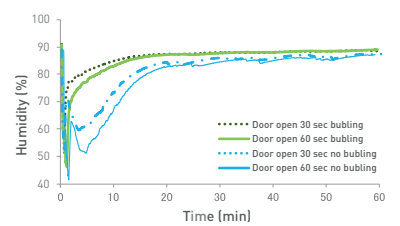

O₂ density recovery

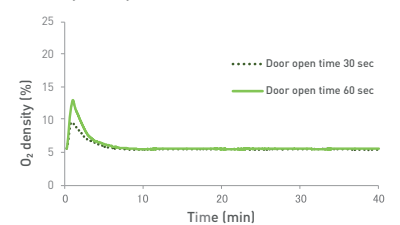

A Powerful Combination



IncuSafe Incubators offer the most precise and regulated environment for cell culture. **PrimeSurface** cell culture plates provide a superior quality three-dimensional cell culture platform with a variety of well shapes to enable spheroid culturing of your specific cell type. This powerful combination optimises cell culture outcomes and reproducibility.

PrimeSurface cell culture labware are ultra low attachment (ULA) dishes and plates that promote scaffold free, self assembly of spheroid formation. The plates are pre-coated with unique ultra hydrophilic polymer that enables spontaneous spheroid formation of uniform size and shape. The ULA plates have high optical clarity making them highly suitable for bright field imaging and confocal microscopy. In addition to the widely used 96 well U bottom plate, 96 well plates are also available in V and M bottom, giving scientists a choice to form tighter spheroids that are needed for specific cell types. For high throughput screening (HTS) needs, 384 well plates are available in clear and white.



