

Register your instrument!  
[www.eppendorf.com/myeppendorf](http://www.eppendorf.com/myeppendorf)



# Centrifuge 5418 R

Original instructions

Copyright© 2019 Eppendorf AG, Germany. All rights reserved, including graphics and images. No part of this publication may be reproduced without the prior permission of the copyright owner.

Microtainer® is a registered trademarks of Becton Dickinson, Franklin Lakes, NJ, USA.

Eppendorf® and the Eppendorf Brand Design are registered trademarks of Eppendorf AG, Germany.

Registered trademarks and protected trademarks are not marked in all cases with ® or ™ in this manual.

U.S. Patents are listed on [www.eppendorf.com/ip](http://www.eppendorf.com/ip)

## Table of contents

<b>1</b>	<b>Operating instructions</b>	<b>5</b>
1.1	Using this manual	5
1.2	Danger symbols and danger levels	5
1.2.1	Danger symbols	5
1.2.2	Danger levels	5
1.3	Symbols used	5
1.4	Abbreviations used	6
<b>2</b>	<b>Safety</b>	<b>7</b>
2.1	Intended use	7
2.2	User profile	7
2.3	Information on product liability	7
2.4	Application limits	8
2.4.1	Declaration concerning the ATEX directive (2014/34/EU)	8
2.5	Warnings for intended use	8
2.5.1	Personal injury or damage to device	8
2.5.2	Incorrect handling of the centrifuge	11
2.5.3	Incorrect handling of the rotors	11
2.5.4	Extreme strain on the centrifugation tubes	12
2.6	Safety instructions on the device	13
<b>3</b>	<b>Product description</b>	<b>15</b>
3.1	Product overview	15
3.2	Delivery package	16
3.3	Features	16
3.4	Name plate	17
<b>4</b>	<b>Installation</b>	<b>19</b>
4.1	Selecting the location	19
4.2	Preparing installation	20
4.3	Installing the instrument	21
<b>5</b>	<b>Operation</b>	<b>23</b>
5.1	Operating controls	23
5.2	Preparing for centrifugation	24
5.2.1	Switching on the centrifuge	24
5.2.2	Inserting the rotor	24
5.2.3	Loading the rotor	25
5.2.4	Closing the rotor lid	26
5.2.5	Closing the centrifuge lid	26
5.3	Cooling	27
5.3.1	Temperature adjustment	27
5.3.2	Temperature display	27
5.3.3	Temperature monitoring	27
5.3.4	FastTemp	27
5.3.5	Continuous cooling	28

**Table of contents**Centrifuge 5418 R  
English (EN)

5.4	Centrifugation . . . . .	29
5.4.1	Centrifuging with time setting . . . . .	29
5.4.2	Centrifuging in continuous operation . . . . .	30
5.4.3	Short run centrifugation . . . . .	30
5.4.4	Removing the rotor . . . . .	31
5.5	Other functions . . . . .	31
5.6	Aerosol-tight centrifugation . . . . .	32
5.6.1	Aerosol-tight centrifugation in a fixed-angle rotor . . . . .	32
5.7	Switching off the centrifuge . . . . .	33
<b>6</b>	<b>Maintenance . . . . .</b>	<b>35</b>
6.1	Service . . . . .	35
6.2	Preparing cleaning/disinfection . . . . .	35
6.3	Cleaning/disinfection . . . . .	36
6.3.1	Cleaning and disinfecting the device . . . . .	37
6.3.2	Cleaning and disinfecting the rotor . . . . .	38
6.4	Additional care instructions for refrigerated centrifuges . . . . .	38
6.5	Cleaning glass breakage . . . . .	39
6.6	Fuses . . . . .	39
6.7	Decontamination before shipment . . . . .	40
<b>7</b>	<b>Troubleshooting . . . . .</b>	<b>41</b>
7.1	General errors . . . . .	41
7.2	Error messages . . . . .	42
7.3	Emergency lid release . . . . .	43
<b>8</b>	<b>Transport, storage and disposal . . . . .</b>	<b>45</b>
8.1	Transport . . . . .	45
8.2	Storage . . . . .	45
8.3	Disposal . . . . .	46
<b>9</b>	<b>Technical data . . . . .</b>	<b>47</b>
9.1	Power supply . . . . .	47
9.2	Ambient conditions . . . . .	47
9.3	Weight/dimensions . . . . .	47
9.4	Noise level . . . . .	48
9.5	Application parameters . . . . .	48
9.6	Service life of accessories . . . . .	49
<b>10</b>	<b>Rotors for the Centrifuge 5418 R . . . . .</b>	<b>51</b>
10.1	Rotor FA-45-18-11 . . . . .	51
10.1.1	rcf display and calculation . . . . .	52
<b>11</b>	<b>Ordering information . . . . .</b>	<b>53</b>
11.1	Accessories . . . . .	53
11.2	Fuses . . . . .	53
	<b>Certificates . . . . .</b>	<b>55</b>

## 1 Operating instructions







### 1.1 Using this manual

- ▶ Read this operating manual completely before using the device for the first time. Observe the instructions for use of the accessories where applicable.
- ▶ This operating manual is part of the product. Please keep it in a place that is easily accessible.
- ▶ Enclose this operating manual when transferring the device to third parties.
- ▶ The current version of the operating manual for all available languages can be found on our webpage [www.eppendorf.com/manuals](http://www.eppendorf.com/manuals).

### 1.2 Danger symbols and danger levels

#### 1.2.1 Danger symbols

The safety instructions in this manual have the following danger symbols and danger levels:

	Biohazard		Explosive substances
	Electric shock		Risk of crushing
	Hazard point		Material damage

#### 1.2.2 Danger levels

<b>DANGER</b>	<i>Will</i> lead to severe injuries or death.
<b>WARNING</b>	<i>May</i> lead to severe injuries or death.
<b>CAUTION</b>	May lead to light to moderate injuries.
<b>NOTICE</b>	May lead to material damage.

### 1.3 Symbols used

Depiction	Meaning
1. 2.	Actions in the specified order
▶	Actions without a specified order
•	List
<i>Text</i>	Display or software texts
	Additional information

## **1.4 Abbreviations used**

**PCR**

Polymerase Chain Reaction

**rcf**

Relative centrifugal force : *g*-force in  $m/s^2$

**rpm**

Revolutions per minute

**UV**

Ultraviolet radiation

## **2 Safety**

### **2.1 Intended use**

The Centrifuge 5418 R is used for the separation of aqueous solutions and suspensions of different densities in approved sample tubes.

The Centrifuge 5418 R is exclusively intended for use indoors. All country-specific safety requirements for operating electrical equipment in the laboratory must be observed.

### **2.2 User profile**

The device and accessories may only be operated by trained and skilled personnel.

Before using the device, read the operating manual and the instructions for use of the accessories carefully and familiarize yourself with the device's mode of operation.

### **2.3 Information on product liability**

In the following cases, the designated protection of the device may be affected. The liability for any resulting damage or personal injury is then transferred to the owner:

- The device is not used in accordance with the operating manual.
- The device is used outside of its intended use.
- The device is used with accessories or consumables that are not recommended by Eppendorf.
- The device is maintained or repaired by persons not authorized by Eppendorf AG.
- The user makes unauthorized changes to the device.

## 2.4 Application limits

### 2.4.1 Declaration concerning the ATEX directive (2014/34/EU)

---



**DANGER! Risk of explosion.**

- ▶ Do not operate the device in areas where explosive substances are handled.
  - ▶ Do not use this device to process any explosive or highly reactive substances.
  - ▶ Do not use this device to process any substances which may generate an explosive atmosphere.
- 

Due to its design and the environmental conditions inside the device, the Centrifuge 5418 R is not suitable for use in a potentially explosive atmosphere.

The device may only be used in a safe environment, such as in the open environment of a ventilated laboratory or a fume hood. The use of substances that may contribute to a potentially explosive atmosphere is not permitted. The final decision on the risks associated with the use of such substances lies with the user.

## 2.5 Warnings for intended use

### 2.5.1 Personal injury or damage to device

---



**WARNING! Electric shock due to damage to the device or mains/power cord.**

- ▶ Only switch on the device if the device and mains/power cord are undamaged.
- ▶ Only operate devices which have been installed or repaired properly.
- ▶ In case of danger, disconnect the device from the mains/power supply voltage. Disconnect the mains/power plug from the device or the earth/grounded socket. Use the isolating device intended for this purpose (e.g. the emergency switch in the laboratory).



**WARNING! Lethal voltages inside the device.**

If you touch any parts which are under high voltage you may experience an electric shock. Electric shocks cause injuries to the heart and respiratory paralysis.

- ▶ Ensure that the housing is closed and undamaged.
- ▶ Do not remove the housing.
- ▶ Ensure that no liquids can penetrate the device.

Only authorized service staff may open the device.



**WARNING! Danger due to incorrect voltage supply.**

- ▶ Only connect the device to voltage sources which correspond with the electrical requirements on the name plate.
- ▶ Only use earth/grounded sockets with a protective earth (PE) conductor.
- ▶ Only use the mains/power cord supplied.





**WARNING! Damage to health due to infectious liquids and pathogenic germs.**

- ▶ When handling infectious liquids and pathogenic germs, observe the national regulations, the biosafety level of your laboratory, the material safety data sheets, and the manufacturer's application notes.
- ▶ Wear your personal protective equipment.
- ▶ For comprehensive regulations about handling germs or biological material of risk group II or higher, please refer to the "Laboratory Biosafety Manual" (source: World Health Organization, Laboratory Biosafety Manual, the current edition).



**WARNING! Risk of injury when opening or closing the centrifuge lid**

There is a risk of crushing your fingers when opening or closing the centrifuge lid.

- ▶ Do not reach between the device and centrifuge lid when opening or closing the centrifuge lid.
- ▶ Do not reach into the locking mechanism of the centrifuge lid.
- ▶ Open the centrifuge lid fully to ensure that the centrifuge lid cannot slam shut.



**WARNING! Risk of injury from rotating rotor.**

If the emergency release of the lid is activated, the rotor may continue to rotate for several minutes.

- ▶ Wait for the rotor to stop before activating the emergency release.
- ▶ To check, look through the monitoring glass in the centrifuge lid.



**WARNING! Risk of injury from chemically or mechanically damaged accessories.**

Even minor scratches and cracks can lead to severe internal material damage.

- ▶ Protect all accessory parts from mechanical damage.
- ▶ Inspect the accessories for damage before each use. Replace any damaged accessories.
- ▶ Do not use rotors or rotor lids that show signs of corrosion or mechanical damage (e.g., deformations).
- ▶ Do not use accessories that have exceeded their maximum service life.



**CAUTION! Poor safety due to incorrect accessories and spare parts.**

The use of accessories and spare parts other than those recommended by Eppendorf may impair the safety, functioning and precision of the device. Eppendorf cannot be held liable or accept any liability for damage resulting from the use of accessories and spare parts other than those recommended, or from the improper use of such equipment.

- ▶ Only use accessories and original spare parts recommended by Eppendorf.

**NOTICE! Device damage due to spilled liquids.**

1. Switch off the device.
2. Disconnect the device from the mains/power supply.
3. Carefully clean the device and the accessories in accordance with the cleaning and disinfection instructions in the operating manual.
4. If a different cleaning and disinfecting method is to be used, contact Eppendorf AG to ensure that the intended method will not damage the device.

**NOTICE! Damage to electronic components due to condensation.**

Condensate may form in the device when it has been transported from a cool environment to a warmer environment.

- ▶ After installing the device, wait for at least 4 h. Only then connect the device to the mains/power line.
-

## 2.5.2 Incorrect handling of the centrifuge

---



**NOTICE! Damage from knocking against or moving the device during operation.**

A rotor that hits against the rotor chamber wall will cause considerable damage to the device and rotor.

- ▶ Do not move or knock against the device during operation.
- 

## 2.5.3 Incorrect handling of the rotors

---



**WARNING! Risk of injury from improperly attached rotors and rotor lids.**

- ▶ Only centrifuge with the rotor and rotor lid firmly tightened.
  - ▶ If unusual noises occur when the centrifuge starts, the rotor or rotor lid may not be attached properly. Stop the centrifugation immediately.
- 



**CAUTION! Risk of injury due to asymmetric loading of a rotor.**

- ▶ Load rotors symmetrically with identical tubes.
  - ▶ Only load adapters with suitable tubes.
  - ▶ Always use the same type of tubes (weight, material/density and volume).
  - ▶ Check symmetric loading by balancing the adapters and tubes used with a balance.
- 



**CAUTION! Risk of injury from overloaded rotor.**

The centrifuge is designed for the centrifugation of material with a maximum density of 1.2 g/mL at maximum speed and filling volume and/or load.

- ▶ Do not exceed the maximum load of the rotor.
- 



**NOTICE! Damage to rotors from aggressive chemicals.**

Rotors are high-quality assemblies which can withstand extreme stresses. This stability can be impaired by aggressive chemicals.

- ▶ Avoid using aggressive chemicals such as strong and weak alkalis, strong acids, solutions with mercury ions, copper ions and other heavy metal ions, halogenated hydrocarbons, concentrated saline solutions and phenol.
  - ▶ If it is contaminated by aggressive chemicals, clean the rotor and especially the rotor bores immediately using a neutral cleaning agent.
  - ▶ Due to the manufacturing process, color variations may occur on PTFE coated rotors. These color variations do not affect the service life or resistance to chemicals.
-

## 2.5.4 Extreme strain on the centrifucation tubes

---



**CAUTION! Risk of injury from overloaded tubes.**

- ▶ Note the loading limits specified by the tube manufacturer.
  - ▶ Only use tubes which are approved by the manufacturer for the required *g*-forces (rcf).
- 



**NOTICE! Risk from damaged tubes.**

Damaged tubes must not be used. This could cause further damage to the device and the accessories as well as sample loss.

- ▶ Visually check all tubes for damage before use.



**NOTICE! Danger due to deformed or brittle tubes. Autoclaving at excessive temperatures can lead to plastic tubes becoming brittle and deformed.**

This could cause damage to the device and the accessories and sample loss.

- ▶ Observe the temperatures specified by the manufacturer when autoclaving tubes.
- ▶ Do not use deformed or brittle tubes.



**NOTICE! Danger due to open tube lids.**

Open tube lids may break off during centrifugation and damage both the rotor and the centrifuge.

- ▶ Carefully seal all tube lids before centrifuging.









**NOTICE! Damage to plastic tubes due to organic solvents.**

When using organic solvents (e.g., phenol, chloroform), the strength of plastic tubes may be reduced and the tubes may become damaged.

- ▶ Observe the manufacturer's information on the chemical resistance of the tubes.
-

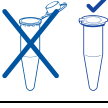
## 2.6 Safety instructions on the device

Symbol	Meaning	Location
	<b>NOTICE</b> ▶ Observe the safety instructions in the operating manual.	Right side of the device
	▶ Observe the operating manual.	
	• Warning: Possible hand injury	Upper side of the device, under the centrifuge lid.
	▶ Always tighten the rotor with the enclosed rotor key.	Upper side of the device, under the centrifuge lid.
	▶ Seal all tubes. ▶ Use the rotor lid.	Upper side of the device, under the centrifuge lid.
	Warning of biological risks when handling infectious liquids or pathogenic germs.	Aerosol-tight fixed-angle rotors: rotor lid

**Safety**

Centrifuge 5418 R  
English (EN)

### 3 Product description

#### 3.1 Product overview

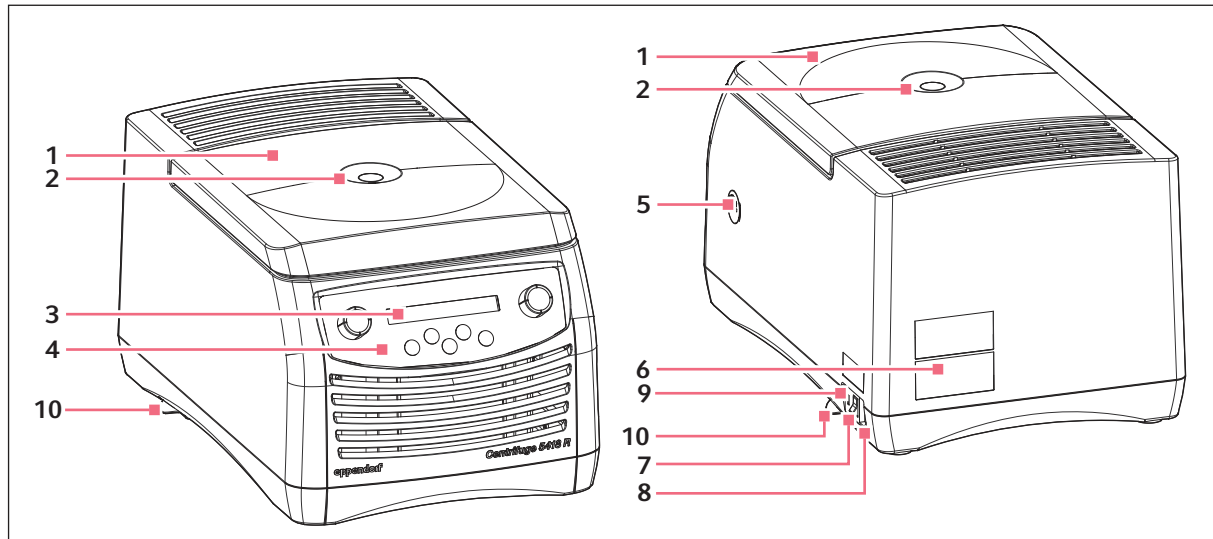

Fig. 3-1: Front and rear view of the Centrifuge 5418 R

- |   |   |
|---|---|
| <b>1 Centrifuge lid</b>   | <b>6 Name plate</b>   |
| <b>2 Monitoring glass</b><br>Visual monitoring for rotor stop or speed control option using stroboscope | <b>7 Mains/power switch</b><br>Switch for switching the device on and off.<br>Switch position 0: The device is switched off.<br>Switch position I: The device is switched on. |
| <b>3 Display</b><br>Display of centrifugation parameters and device settings                            | <b>8 Mains/power connection</b><br>Connection socket for the mains cable supplied.  |
| <b>4 Control panel</b><br>For operation of the centrifuge.  | <b>9 Fuse holder</b>  |
| <b>5 Emergency lid release</b>  | <b>10 Condensation water tray</b>   |

**Product description**

Centrifuge 5418 R  
English (EN)

**3.2 Delivery package**

1	Centrifuge 5418 R
1	Rotor key
1	Mains/power cord
1	Directions
1	Condensation water tray
1	Set of fuses



- ▶ Check whether the delivery is complete.
- ▶ Check all parts for any transport damage.
- ▶ To safely transport and store the device, retain the transport box and packing material.

**3.3 Features**

The space-saving and easy-to-use Centrifuge 5418 R has a capacity of 18 x 2 mL and achieves a maximum of 16873 x *g* / 14000 rpm. The microcentrifuge is equipped with an aerosol-tight standard rotor for centrifugation of the following tubes:

- Micro test tubes (0.2 to 2.0 ml)
- Microtainers (0.6 ml)
- Spin columns (1.5/2.0 ml)

The Centrifuge 5418 R has an additional temperature control function for centrifugation between 0 °C and +40 °C. The **fast temp** function can be used to start a temperature control run without samples to adjust the rotor chamber incl. rotor and adapters quickly to the set target temperature.



### 3.4 Name plate

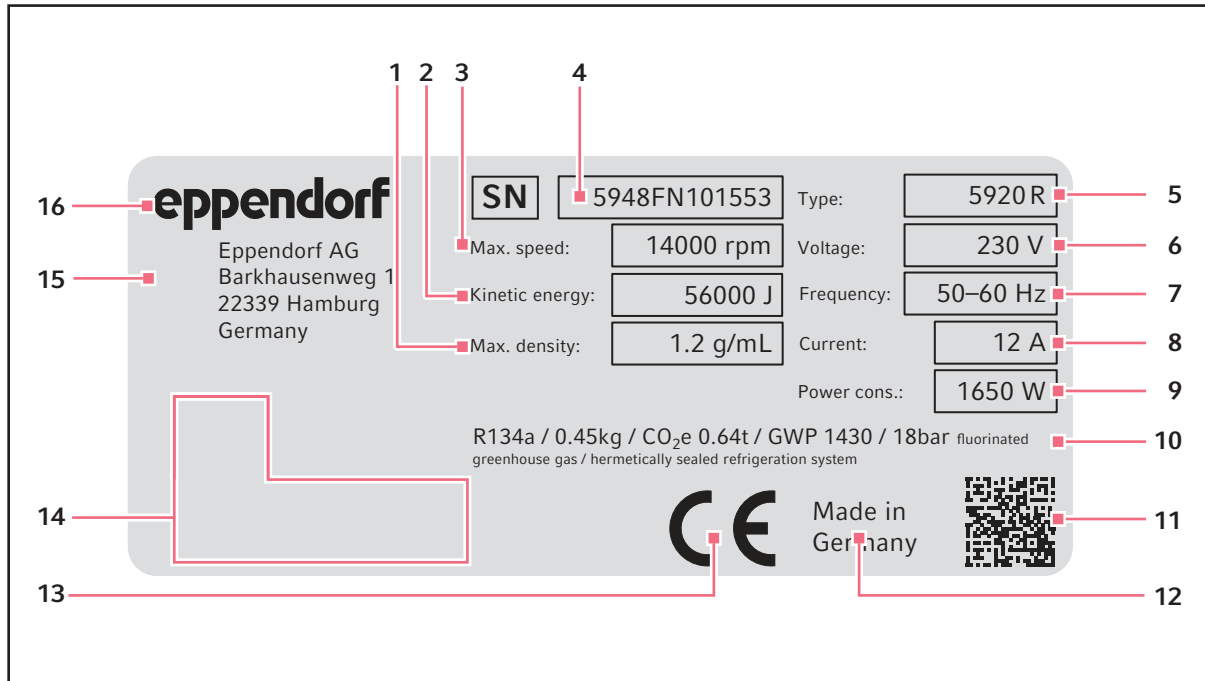







Fig. 3-2: Eppendorf AG device identification (example)

- |   |  |
|---|--|
| <ul style="list-style-type: none"> <li>1 Maximum density of the material for centrifuging</li> <li>2 Maximum kinetic energy</li> <li>3 Maximum speed</li> <li>4 Serial number</li> <li>5 Product name</li> <li>6 Rated voltage</li> <li>7 Rated frequency</li> <li>8 Maximum rated current</li> </ul> | <ul style="list-style-type: none"> <li>9 Maximum rated power</li> <li>10 Information on the refrigerant (refrigerated centrifuges only)</li> <li>11 Data matrix code for serial number</li> <li>12 Designation of origin</li> <li>13 CE marking</li> <li>14 Certification marks and symbols (device-specific)</li> <li>15 Manufacturer's address</li> <li>16 Manufacturer</li> </ul> |
|---|--|

**Product description**Centrifuge 5418 R  
English (EN)

Tab. 3-1: Certification and conformity marks and symbols (device-specific)

Symbol/sign	Meaning
	Serial number
	Mark for waste electrical and electronic equipment in accordance with the EN 50419 standard in accordance with directive 2012/19/EU (WEEE) of the European Union
	UL listing certification mark: Representative samples of the device have been tested by Underwriters Laboratories (UL) in accordance with the applicable safety standards for the USA and Canada
	FCC mark of conformity; electromagnetic compatibility tested in accordance with <i>Federal Communications Commission</i> (FCC, USA) regulations
	RoHS mark in accordance with standard SJ/T 11364, <i>Marking for the restriction of the use of hazardous substances in electrical and electronic products</i> , People's Republic of China
	Conformity with the relevant directives for the Eurasian Economic Union

## 4 Installation

### 4.1 Selecting the location

---



**WARNING! Danger due to incorrect voltage supply.**

- ▶ Only connect the device to voltage sources which correspond with the electrical requirements on the name plate.
  - ▶ Only use earth/grounded sockets with a protective earth (PE) conductor.
  - ▶ Only use the mains/power cord supplied.
- 



**NOTICE! If an error occurs, objects in the immediate vicinity of the device may become damaged.**

- ▶ In accordance with the recommendations of EN 61010-2-020, leave a safety clearance of **30 cm** around the device during operation.
  - ▶ Please remove all materials and objects from this area.
- 



**NOTICE! Damage due to overheating.**

- ▶ Do not install the device near heat sources (e.g. heating, drying cabinet).
  - ▶ Do not expose the device to direct sunlight.
  - ▶ Ensure unobstructed air circulation. Maintain a clearance of at least 30 cm around all ventilation gaps.
- 



**NOTICE! Radio interference.**

For devices with Class A noise emission in accordance with EN 61326-1/EN 55011, the following applies: This device has been developed and tested in accordance with CISPR 11 Class A. The device may cause radio interference in domestic environments and is not intended for use in residential areas. The device cannot ensure adequate protection of radio reception in residential areas and domestic environments.

- ▶ If necessary, take appropriate measure to eliminate the interferences.
- 



Mains/power connection for centrifuges: Operation of the centrifuge is only permitted in building installations that comply with the applicable national regulations and standards. In particular, it must be ensured that there are no impermissible loads on the supply lines and assemblies that are located upstream of the internal protection of the device. This can be ensured by additional circuit breakers or other suitable safety elements in the building installation.



The mains/power switch and the disconnecting device of the mains/power line must be easily accessible during operation (e.g. a residual current circuit breaker).

Select the location of the device according to the following criteria:

- Mains/power connection in accordance with the name plate
  - Minimum distance to other devices and walls: 30 cm
  - Resonance free table with horizontal even work surface
  - The surrounding area must be well ventilated.
  - The location is protected against direct sunlight.
- ▶ Do not use this device near strong electromagnetic sources (e.g. unshielded high frequency sources) as they could impede proper functioning of the device.

## 4.2 Preparing installation

The weight of the Centrifuge 5418 R is 22 kg. A second person is needed to unpack and position the device.

### Unpacking the centrifuge

1. Open the packaging box.
2. Remove the accessories.
3. Lift the centrifuge out of the box with the help of another person.
4. Remove the front and back transport protection pads.
5. Place the centrifuge on a suitable lab bench.
6. Remove the plastic sleeve.

## 4.3 Installing the instrument

### Prerequisites

The device is on a suitable lab bench.



#### **WARNING! Danger due to incorrect voltage supply.**

- ▶ Only connect the device to voltage sources which correspond with the electrical requirements on the name plate.
- ▶ Only use earth/grounded sockets with a protective earth (PE) conductor.
- ▶ Only use the mains/power cord supplied.



#### **NOTICE! Damage to electronic components due to condensation.**

Condensate may form in the device when it has been transported from a cool environment to a warmer environment.

- ▶ After installing the device, wait for at least 4 h. Only then connect the device to the mains/power line.

- 
1. Let the device warm up to ambient temperature.
  2. Connect the centrifuge to the mains/power line and switch it on at the mains/power switch.
    - The display is active.
    - The lid opens automatically.
  3. Remove the transport securing device.
  4. Turn the rotor nut **counterclockwise** with the rotor key included in the delivery.
  5. Lift the rotor out vertically.
  6. Remove the transport protection pad from the motor shaft.
  7. Insert the condensation water tray at the side of the device into the holder provided.



## 5 Operation

### 5.1 Operating controls

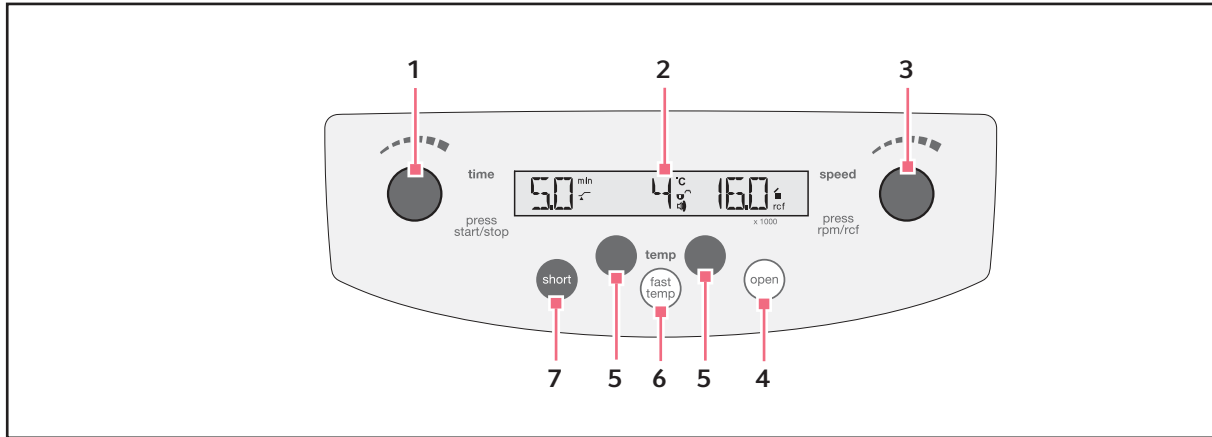

Fig. 5-1: Control panel

- 1 Set the centrifugation time**  
To start and stop the centrifugation, press the **time** rotary knob.
- 2 Display**
- 3 Set the speed of centrifugation**  
Press the **rotary knob** to switch to the displayed centrifugation speed (rpm/rcf).
- 4 Release the lid**
- 5 Set the temperature**
- 6 Start a fast temp temperature control run**
- 7 Short run centrifugation**

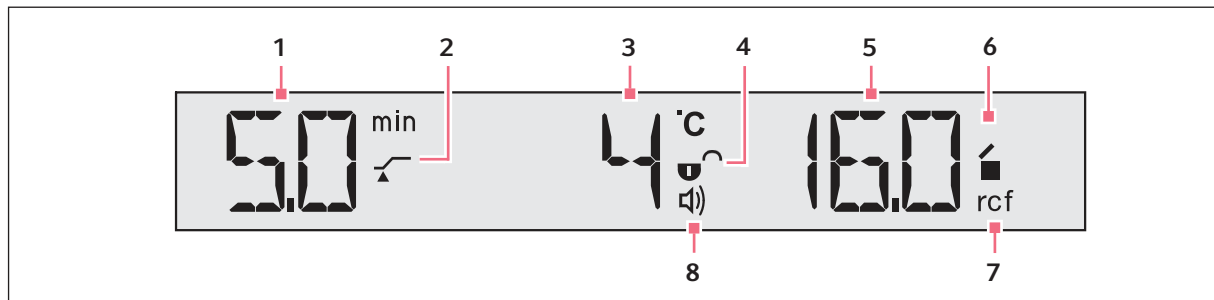

Fig. 5-2: Display

- |  |   |
|--|---|
| <p><b>1 Centrifugation time</b></p> <p><b>2 At set rpm</b><br/> : Start of run time when reaching 95% of the preset g-force (rcf) or speed (rpm).<br/> : Immediate start of run time.</p> <p><b>3 Temperature</b></p> <p><b>4 Key lock status</b><br/> : Centrifugation parameters cannot be modified unintentionally.<br/> : No key lock.</p> | <p><b>5 g-force (rcf) or speed (rpm)</b><br/>Set value x 1000</p> <p><b>6 Centrifuge status</b><br/> : Centrifuge lid unlocked.<br/> : Centrifuge lid locked.<br/>  (Flashes): centrifugation in progress.</p> <p><b>7 Status of centrifugation speed display</b><br/> <b>rcf</b>: g-force (relative centrifugal force, rcf)<br/> <b>rpm</b>: Speed (revolutions per minute)</p> <p><b>8 Loudspeaker status</b><br/> : Switched on<br/> No symbol: switched off</p> |
|--|---|

## 5.2 Preparing for centrifugation

### 5.2.1 Switching on the centrifuge

- Switch on the centrifuge at the mains/power switch.  
After switching the device on at the mains/power switch, the centrifuge lid opens automatically.
- Open the closed centrifuge lid by pressing the **open** key.  
The parameter settings of the last run are displayed.

### 5.2.2 Inserting the rotor



**NOTICE! If handled incorrectly, the rotor may fall.**

The rotor lid screw may become loose if it is used to hold the rotor.

- ▶ Always grasp the rotor with both hands for holding or transport.

- Place the rotor vertically on the motor shaft.
- Insert the supplied rotor key into the rotor nut.
- Turn the rotor key **clockwise** until the rotor nut is firmly tightened.



### 5.2.3 Loading the rotor



**CAUTION! Risk of injury due to asymmetric loading of a rotor.**

- ▶ Load rotors symmetrically with identical tubes.
- ▶ Only load adapters with suitable tubes.
- ▶ Always use the same type of tubes (weight, material/density and volume).
- ▶ Check symmetric loading by balancing the adapters and tubes used with a balance.



**CAUTION! Risk from damaged or overloaded tubes.**

- ▶ When loading the rotor, observe the safety instructions for hazards resulting from overloaded or damaged tubes.

To load the rotor, proceed as follows:

1. Check the maximum load (adapter, tube and contents) per rotor bore.  
The maximum load is 3.75 g per rotor bore. This information can also be found on the rotor.
2. Load rotors and adapters only with the tubes intended for them.
3. Insert tubes opposite each other in pairs into the rotor bores. To ensure symmetric loading, tubes that are arranged opposite each other must be of the same type and contain the same filling quantity.

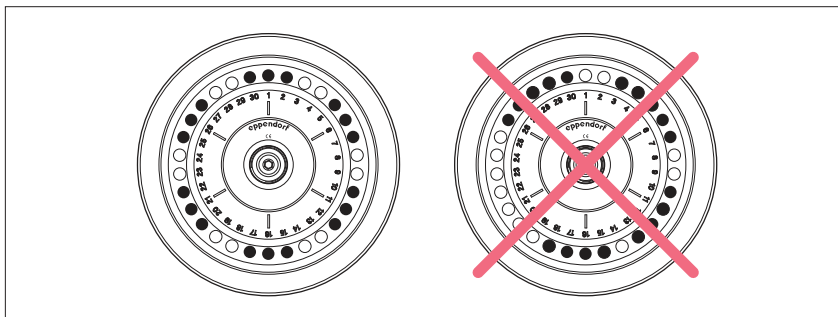

To keep the weight differences between the filled tubes low, we recommend taring with a balance. This protects the drive and reduces operating noise.

### 5.2.4 Closing the rotor lid



With the rotor FA-45-18-11 centrifugation is also possible without a rotor lid.

Please also note:

- The tube lids must be closed securely.
- Without the rotor lid, the rotor is not aerosol-tight.
- The centrifugation is slightly louder.
- Spin columns must always be centrifuged with a rotor lid.

1. Check that the external sealing washer is correctly positioned in the groove.
2. Place the rotor lid vertically on the rotor.
3. Lock the rotor by turning the red rotor lid screw clockwise beyond an audible *click* until it can be turned no further.

**The rotor is correctly locked only after the audible "click" is heard!**

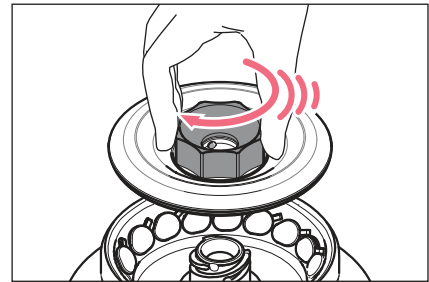

If the locking system is difficult to operate, lightly grease the pins in the rotor lid screw and the rotor lid seal with pivot grease.

### 5.2.5 Closing the centrifuge lid



**WARNING! Risk of injury when opening or closing the centrifuge lid**

There is a risk of crushing your fingers when opening or closing the centrifuge lid.

- ▶ Do not reach between the device and centrifuge lid when opening or closing the centrifuge lid.
- ▶ Do not reach into the locking mechanism of the centrifuge lid.
- ▶ Open the centrifuge lid fully to ensure that the centrifuge lid cannot slam shut.

1. Check correct attachment of rotor and rotor lid.
2. Push down the centrifuge lid until the lid latch engages and the lid is automatically closed.

The centrifuge will close automatically.

The display shows the ■ symbol.

The **open** key lights up blue.

## 5.3 Cooling

### 5.3.1 Temperature adjustment

- ▶ Select a temperature (0 °C to +40 °C) using the arrow keys **temp**.

### 5.3.2 Temperature display

If the rotor is stopped:	Set temperature
During centrifugation:	Actual temperature

### 5.3.3 Temperature monitoring

After the set temperature has been reached, the centrifuge reacts to temperature deviations during centrifugation as follows:

Deviation from the target value	Action
$\Delta T > 3^{\circ}\text{C}$	Temperature display flashes.
$\Delta T > 5^{\circ}\text{C}$	Periodic warning tone and display <i>Error 18</i> . Centrifugation is stopped automatically.

### 5.3.4 FastTemp

With this function, you can immediately start a temperature run without samples, at rotor- or temperature-specific speeds. This will quickly bring the rotor chamber, including rotor and adapter, up to the set target temperature.

Prerequisites

- The centrifuge is switched on.
- The rotor and rotor lid are attached properly.
- The centrifuge lid is closed.
- Temperature and *g*-force (rcf)/speed (rpm) for the centrifugation are set (see *Centrifugation on p. 29*).

1. Press the **fast temp** key.

The display shows *FT*, the current temperature and *g*-force (rcf)/speed (rpm).

The cooling time from room temperature ( $\approx 23^{\circ}\text{C}$ ) to  $4^{\circ}\text{C}$  takes .

The temperature control run ends automatically when the set temperature is reached. A periodic signal tone sounds.

2. Press the **start/stop** key to end the temperature control run early.

After the set temperature has been achieved and the temperature control run has ended, the centrifuge will keep the rotor chamber at the set temperature if it is below ambient room temperature and the lid is closed. However, independent of the target temperature,  $4^{\circ}\text{C}$  must be met via this continuous cooling in order to prevent the rotor chamber from freezing.



The centrifuge stops the run automatically when the rotor has reached the set temperature. Therefore, there may be a delay between the display of the achieved target temperature and the automatic end of the temperature control run.

### 5.3.5 Continuous cooling

If the rotor stops, the rotor chamber will be maintained at the set temperature if the following requirements have been met:

- The centrifuge is switched on.
- The centrifuge lid is closed.
- The set temperature is lower than the ambient temperature.

The following factors apply during the continuous cooling:

- The set temperature will be displayed.
- Independent of the set temperature, 4 °C must be achieved in order to prevent the rotor chamber or sample from freezing and to prevent increased condensation in the device.
- The temperature adjustment takes longer because the rotor is not rotating.

Open the centrifuge lid to end continuous cooling.

If the centrifuge is not used for more than 8 hours, the continuous cooling is switched off automatically. This protects against ice formation in the rotor chamber and the tubes, and against increased condensation in the device.

The actual temperature is displayed.

## 5.4 Centrifugation



### CAUTION! Danger due to incorrectly loaded rotors and damaged/overloaded tubes!

- ▶ Before commencing centrifugation, follow the safety instructions relating to risks from asymmetrically loaded and/or overloaded rotors and from overloaded, damaged and/or open tubes.



### WARNING! Risk of injury from improperly attached rotors and rotor lids.

- ▶ Only centrifuge with the rotor and rotor lid firmly tightened.
- ▶ If unusual noises occur when the centrifuge starts, the rotor or rotor lid may not be attached properly. Stop the centrifugation immediately.

Familiarize yourself with the operating controls and the display before using the Centrifuge 5418 R for the first time.

Each of the centrifuging variants described here must be preceded by the preparation described above .

Please also note the instructions on cooling (see p. 27).

### 5.4.1 Centrifuging with time setting

Perform the following steps in the sequence described:

1. Use **time** to set the run time.
2. Use **temp** to set the temperature.
3. Use **speed** to set the g-force (rcf) or speed (rpm).
4. Press **start/stop** to start centrifuging.

#### During centrifugation

- ■ flashes on the display while the rotor is running.
- The current temperature is displayed.
- The **fast temp, open, short** as well as the device menu are blocked during centrifugation.
- During the run you can modify the total run time, the temperature (only ), the speed and the rpm/rcf display. To change the centrifugation parameters, press the **short** key first. The values flash in the display during the change. The new parameters are adopted immediately. When the time is changed during a run, the time which has already elapsed is taken into account. Please note that the shortest new total run time that can be set is the elapsed time plus 2 minutes.
- You can also terminate the centrifugation before the set run time has elapsed by pressing the **start/stop** key.

### End of centrifugation

- The centrifuge stops automatically when the set time has elapsed. During the braking process, the elapsed centrifugation time flashes on the display. When the rotor has stopped, a signal tone sounds.
- The centrifuge lid remains closed to maintain the sample temperature. You can open it by pressing the **open** key.

5. Remove the material for centrifuging.

## 5.4.2 Centrifuging in continuous operation

Perform the following steps in the sequence described:

1. Use **time** to set the continuous run.

The continuous run function can be set above 99 min or below 0.5 min. The timer shows **oo** to indicate continuous operation.

2. Use the **temp** arrow keys to adjust the temperature.

3. Use **speed** to set the g-force (rcf) or speed (rpm).

4. Press **start/stop** to start centrifuging.

■ flashes on the display while the rotor is running.

Time is counted upwards, first in 30-second increments and then in minute increments from ten minutes.

5. Press **start/stop** to end centrifuging after the desired time period.

- During the braking process, the centrifugation time flashes on the display.
- When the rotor has stopped, a signal tone sounds.
- The centrifuge lid remains closed to maintain the sample temperature. You can open it by pressing the **open** key.

6. Remove the material for centrifuging.

## 5.4.3 Short run centrifugation

You can carry out a short run with the currently set or with the maximum g-force (rcf) / speed (rpm). Set this short run mode as described in the following section.

### 5.4.3.1 Selecting short run mode

1. Press the **short** key while the centrifuge lid is open.

The current mode is displayed:

- Display **1 – 14 t** (run at preselected speed)
- Display **14 t** (run at maximum speed of 14,000 rpm)

2. When the centrifuge lid is open, press the **short** key for longer than 2 s to switch between these modes.

### 5.4.3.2 Performing short run centrifugation

1. A short run at preselected g-force (rcf) or speed (rpm) can be set directly using the **speed** dial.
2. Use the **temp** arrow keys to adjust the temperature.
3. Start short run: Hold down the **short** key.
  - ■ flashes on the display while the rotor is running.
  - The time is counted upwards in seconds.
  - During short run centrifuging all other keys are blocked.
4. End short run: Release the **short** key.
  - During the braking process, the centrifugation time flashes on the display.
  - The centrifuge lid remains closed to maintain the sample temperature. You can open it by pressing the **open** key.
5. Remove the material for centrifuging.



During the braking process, you can restart centrifugation up to two times by pressing the **short** key again.

### 5.4.4 Removing the rotor

1. Turn the rotor nut **counterclockwise** with the rotor key included in the delivery.
2. Lift the rotor out vertically.
3. Switch off the centrifuge after use and empty the condensation water tray (pull out from the left or right side of the device). Leave the centrifuge lid fully open and secure it against closing.

## 5.5 Other functions

Function	Status of centrifuge lid	Press > 2 s key	Display
Modify parameter during the cycle.	■ closed	<b>short</b>	Flashes 5 s
Enable/disable signal tone.	🔊 Open	<b>open</b>	🔊
Enable/disable key lock.	🔒 Open	<b>short + open</b>	🔒
At set rpm	🔒 Open	<b>time</b>	🕒

## 5.6 Aerosol-tight centrifugation

---



**WARNING! Damage to health due to limited aerosol tightness with an incorrect rotor/ rotor lid combination.**

Aerosol-tight centrifugation is guaranteed only if the rotors and rotor lids intended for this purpose are used. The designation of aerosol-tight fixed-angle rotors always starts with **FA**. The aerosol-tight rotors and rotor lids of this centrifuge are additionally marked with a red ring on the rotor and a red rotor lid screw.

- ▶ Always use rotors and rotor lids marked aerosol-tight together for aerosol-tight centrifugation. The details specifying in which centrifuge the aerosol-tight rotors and rotor lids may be used can be found on the rotor and on the top of the rotor lid.
- ▶ Only use aerosol-tight rotor lids in combination with the rotors that are specified on the rotor lid.



**WARNING! Damage to health due to limited aerosol-tightness if used incorrectly.**

Mechanical stresses and contamination by chemicals or other aggressive solvents may impair the aerosol tightness of the rotors and rotor lids. Autoclaving at excessive temperatures can lead to vessels, adapters and rotor lids becoming brittle and deformed.

- ▶ Check the integrity of the seals of the aerosol-tight rotor lids or caps before each use.
- ▶ Only use aerosol-tight rotor lids or caps if the seals are undamaged and clean.
- ▶ Do not exceed temperatures of 121°C or a time of more than 20 min. while autoclaving.
- ▶ After each proper autoclaving process (121 °C, 20 min.), coat the threads of the rotor lid screw with a thin layer of pivot grease (order no. Int. 5810 350.050, North America 022634330).
- ▶ Replace aerosol-tight rotor lids without replaceable seals after 50 autoclaving cycles.
- ▶ Only the seal of aerosol-tight rotor lids with exchangeable seals (e.g. QuickLock rotor lids) must be replaced after 50 autoclaving cycles.
- ▶ **Never** store aerosol-tight rotors or buckets closed.



The aerosol tightness of rotors, rotor lids, buckets and caps has been tested and certified according to Annex AA of IEC 61010-2-020.

### 5.6.1 Aerosol-tight centrifugation in a fixed-angle rotor

**To ensure aerosol tightness, the following applies:**

- Replace aerosol-tight rotor lids without exchangeable seal and cap after 50 autoclaving cycles.
- Replace the seal of aerosol-tight rotor lids with exchangeable seal (e.g. QuickLock rotor lids) after 50 autoclaving cycles.
- Lightly grease the replaced seal with pivot grease after it is inserted.



## **5.7 Switching off the centrifuge**

1. Open the centrifuge lid.  
Residual moisture can evaporate.
2. Remove rotor lids from fixed-angle rotors.  
Aerosol-tight accessories may not be stored with the lid closed.
3. Switch off the centrifuge using the mains/power switch.



## 6 Maintenance

### 6.1 Service



#### WARNING! Risk of fire or electrical shock

- ▶ Have the centrifuge's electrical safety, especially the paths for the protective connections, checked every 12 months by trained and skilled personnel.

We recommend to have the centrifuge and the associated rotors checked by Technical Service during a service at least every 12 months. Please note the country-specific regulations.

### 6.2 Preparing cleaning/disinfection

- ▶ Clean all accessible surfaces of the device and the accessories at least weekly and when contaminated.
- ▶ Clean the rotor regularly. This way the rotor is protected and the durability is prolonged.
- ▶ Furthermore, observe the notes on decontamination (see *Decontamination before shipment on p. 40*) when the device is sent to the authorized Technical Service for repairs.

The procedure described in the following chapter applies to the cleaning as well as to the disinfection or decontamination. The table below describes the steps required on top of this:

Cleaning	Disinfecting/decontamination
<ol style="list-style-type: none"> <li>1. Use a mild cleaning fluid to clean the accessible surfaces of the device and the accessories.</li> <li>2. Carry out the cleaning as described in the following chapter.</li> </ol>	<ol style="list-style-type: none"> <li>1. Choose the disinfection method which corresponds to the legal regulations and guidelines in place for your range of application. For example, use alcohol (ethanol, isopropanol) or alcohol-based disinfectants.</li> <li>2. Carry out the disinfection or decontamination as described in the following chapter.</li> <li>3. Then clean the device and the accessories.</li> </ol>



If you have any further questions regarding the cleaning and disinfection or decontamination or regarding the cleaning fluid to be used, contact the Eppendorf AG Application Support. The contact details are provided on the back of this manual.

## 6.3 Cleaning/disinfection

---



### **DANGER! Electric shock due to the ingress of liquid.**

- ▶ Switch off the device and disconnect it from the mains/power line before starting cleaning or disinfection.
  - ▶ Do not allow any liquids to penetrate the inside of the housing.
  - ▶ Do not perform a spray clean/spray disinfection on the housing.
  - ▶ Only reconnect the device to the mains/power line when it is completely dry, both inside and outside.
- 



### **NOTICE! Damage from the use of aggressive chemicals.**

- ▶ Do not use any aggressive chemicals on the device or its accessories, such as strong and weak bases, strong acids, acetone, formaldehyde, halogenated hydrocarbons or phenol.
- ▶ If the device has been contaminated by aggressive chemicals, clean it immediately using a mild cleaning agent.



### **NOTICE! Corrosion due to aggressive cleaning agents and disinfectants.**

- ▶ Do not use any corrosive cleaning agents, aggressive solvents or abrasive polishes.
- ▶ Do not incubate the accessories in aggressive cleaning agents or disinfectants for longer periods.



### **NOTICE! Damage from UV and other high-energy radiation.**

- ▶ Do not use UV, beta, gamma, or any other high-energy radiation for disinfection.
- ▶ Avoid storage in areas with strong UV radiation.



### **NOTICE! Danger due to deformed or brittle tubes. Autoclaving at excessive temperatures can lead to plastic tubes becoming brittle and deformed.**

This could cause damage to the device and the accessories and sample loss.

- ▶ Observe the temperatures specified by the manufacturer when autoclaving tubes.
  - ▶ Do not use deformed or brittle tubes.
- 



### **Autoclaving**

Rotors, rotor lids and adapters can be autoclaved (121 °C, 20 min).

Replace the sealing ring in the lid groove of the aerosol-tight rotor lid after a maximum of 50 autoclaving cycles.



### Aerosol tightness

Check that the seals are intact before use.

Aerosol-tight rotor lids with an exchangeable seal (e.g., QuickLock rotor lids) only: Replace the sealing ring in the lid groove when it becomes worn.

Regular care of the sealing rings is necessary in order to protect the rotors.

Aerosol-tight rotors should never be stored with the lids screwed on!

If the locking system is difficult to operate, lightly grease the pins in the rotor lid screw and the rotor lid seal with pivot grease (order no. int.: 5810 350.050/North America: 022634330).

## 6.3.1 Cleaning and disinfecting the device

1. Open the lid. Switch the device off at the mains/power switch. Disconnect the mains/power plug from the voltage supply.
2. Loosen the rotor nut by turning the rotor key **counterclockwise**.
3. Remove the rotor.
4. Clean and disinfect all accessible surfaces on the device including the mains/power cord using a damp cloth and recommended cleaning agents.
5. Thoroughly clean the rubber seals of the rotor chamber with water.
6. Rub the dry rubber seals with glycerol or talcum powder to prevent them from becoming brittle. Other components of the device, such as the lid latch, motor shaft and rotor cone, must not be lubricated.
7. Clean the motor shaft with a soft, dry, lint-free cloth. Do not grease the motor shaft.
8. Check the motor shaft for damage.
9. Check the device for corrosion and damage.
10. Leave the centrifuge lid open when the device is not being used.
11. Only reconnect the device to the mains/power supply if it is fully dry on the inside and outside.

### 6.3.2 Cleaning and disinfecting the rotor

1. Inspect the rotor and accessories for damage and corrosion. Do not use damaged rotors or accessories.
2. Clean and disinfect the rotors and accessories with the recommended cleaning agents.
3. Clean and disinfect the rotor bores with a bottle brush.
4. Remove the sealing ring to clean and disinfect the rotor lid. Also clean the groove underneath and the sealing ring.

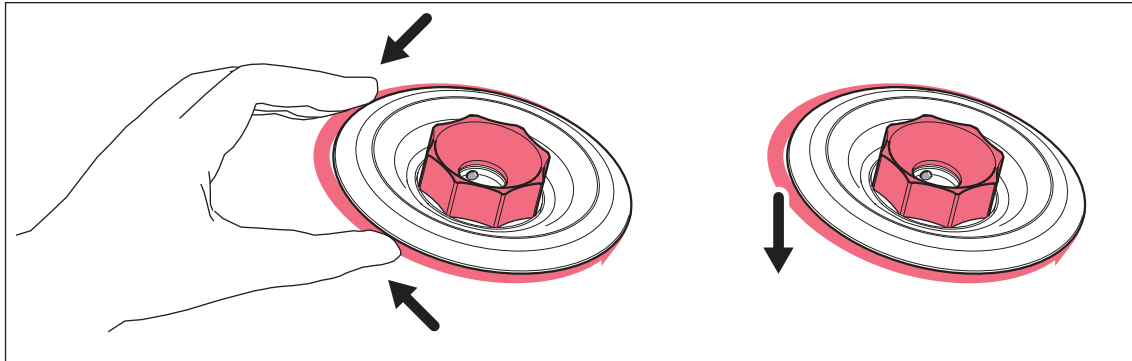

5. Rinse the rotors and accessories thoroughly with distilled water. Rinse the rotor bores of fixed-angle rotors particularly thoroughly.



Do not put the rotor into the dishwasher and do not immerse the rotor in liquid as liquid can enter through the openings when doing so.

6. Place the rotors and accessories on a towel to dry. Place fixed-angle rotors with the rotor bores facing down so the bores can also dry.
7. Correctly reinsert the rotor lid sealing ring in the clean and dry groove.
8. Grease the inserted sealing ring lightly with pivot grease.
9. Clean the rotor cone with a soft, dry, lint-free cloth. Do not lubricate the rotor cone.
10. Inspect the rotor cone for damage.
11. Place the dry rotor onto the motor shaft.
12. Tighten the rotor nut firmly by turning it **clockwise** with the rotor key.
13. Leave the rotor lid open when the rotor is not being used.

### 6.4 Additional care instructions for refrigerated centrifuges

- ▶ Empty and clean the condensation water tray regularly and especially after liquid spillage in the rotor chamber. Pull out the condensation water tray at the front right under the device.
- ▶ Regularly free the rotor chamber from ice formations by thawing, by either leaving the centrifuge lid open or by performing a short temperature control run at approx. 30 °C.
- ▶ Wipe up the condensation water in the rotor chamber. Use a soft, absorbent cloth for this.
- ▶ No later than every 6 months, remove any dust deposits from the ventilation slits of the centrifuge using a brush or swab. First switch off the device and remove the power plug.

## 6.5 Cleaning glass breakage

When using glass tubes there is a risk of glass breakage in the rotor chamber. The resulting glass splinters are swirled around in the rotor chamber during centrifugation and have a sandblasting effect on the rotor and accessories. Very small particles of glass can become lodged in the rubber parts (e.g., the motor sleeve, the rotor chamber seal, and the rubber mats of adapters).



### **NOTICE! Glass breakage in the rotor chamber**

Glass tubes in the rotor chamber may break if the *g*-force is too high. Broken glass can damage the rotor, accessories and samples.

- ▶ Please note the manufacturer's information on the recommended centrifugation parameters (load and speed).

### **Effects of glass breakage in the rotor chamber:**

- Fine black metal abrasion dust in the rotor chamber (with metal rotor bowls).
- The surfaces of the rotor chamber and accessories are scratched.
- The chemical resistance of the rotor chamber is reduced.
- Contamination of samples.
- Wear on rubber parts.

### **How to proceed in case of glass breakage**

1. Remove all splinters and glass powder from the rotor chamber and accessories.
2. Thoroughly clean the rotor and rotor chamber. Thoroughly clean the bores of the fixed-angle rotors, in particular.
3. If required, replace the adapters to prevent any further damage.
4. Regularly check the rotor bores for deposits and damage.

## 6.6 Fuses

The fuse holder is located to the left of the mains switch.

1. Disconnect the mains/power plug.
2. Remove the fuse holder.

Both fuses are now accessible and can be replaced.

## 6.7 Decontamination before shipment

If you are shipping the device to the authorized Technical Service for repairs or to your authorized dealer for disposal please note the following:



**WARNING! Risk to health from contaminated device.**

1. Observe the information in the decontamination certificate. It is available as a PDF document on our webpage ([www.eppendorf.com/decontamination](http://www.eppendorf.com/decontamination)).
  2. Decontaminate all the parts you are going to dispatch.
  3. Include the fully completed decontamination certificate in the shipment.
-



## 7 Troubleshooting

If you cannot remedy an error with the recommended measures, please contact your local Eppendorf partner. The contact address can be found on the Internet at [www.eppendorf.com](http://www.eppendorf.com).

### 7.1 General errors

Problem	Cause	Solution
No display.	No mains/power connection.	▶ Check the mains/power connection.
	Mains/power outage.	▶ Check the fuse of the centrifuge. ▶ Check the mains/power fuse of the lab.
Centrifuge lid cannot be opened.	The rotor is still running.	▶ Wait for the rotor to stop.
	Mains/power outage.	1. Check the fuse of the centrifuge. 2. Check the mains/power fuse of the lab. 3. Activate the emergency lid release.
Centrifuge cannot be started.	The centrifuge lid is not closed.	▶ Close the centrifuge lid.
Centrifuge shakes when it starts up.	The rotor is loaded asymmetrically.	1. Stop the centrifuge and load symmetrically. 2. Restart the centrifuge.
Centrifuge brakes during a short run centrifugation, although the <b>short</b> key is pressed.	The <b>short</b> key was released briefly more than twice (protective function for the drive).	▶ Press the <b>short</b> key continuously during a short run centrifugation.
Temperature display flashes.	Temperature deviation from set value: $\pm 3$ °C.	▶ Check the settings. ▶ Wait until the set temperature has been reached. ▶ Check unhindered air circulation through the air slots. ▶ Thaw ice or switch off the centrifuge and allow it to cool down.

## 7.2 Error messages

If one of the following error messages appears, proceed as follows:

1. Remove fault (see Remedies).
2. If necessary, repeat centrifugation.

Problem	Cause	Solution
<b>LID</b>	Centrifuge lid cannot be locked.	▶ Try to close the centrifuge lid again.
	Centrifuge lid cannot be released.	1. Switch the centrifuge off and back on.  If the error occurs again: 1. Switch off the centrifuge. 2. Activate the emergency lid release.
	Centrifuge lid must not be released during a run.	▶ Wait for the rotor to stop.
<b>INT</b>	Mains/power failure during a run.	▶ Check the mains/power connection.
<b>Error 3</b>	Error in the speed measuring system or drive overheated.	▶ Leave the device switched on until the error message disappears (10 s or 6 min).
<b>Error 5</b>	Prohibited opening of lid or lid switch is defective during a run.	1. Wait for the rotor to stop. 2. Open the centrifuge lid and then close it again. 3. Repeat the run.
<b>Error 6</b>	Drive fault.	▶ Repeat the run. ▶ If this error message appears again, switch centrifuge off and back on again after >20 s.
	The drive is overheated.	▶ Allow the drive to cool down for at least 15 min.
<b>Error 7</b>	Major deviation in the speed check.	1. Wait for the rotor to stop. 2. Tighten the rotor.
<b>Error 8</b>	Drive fault.	1. Wait for the rotor to stop. 2. Repeat the run.
<b>Error 9 to 17</b>	Electronics error.	▶ Switch the centrifuge off and back on again after > 20 s.
<b>Error 18</b>	Too high temperature deviation from set value in the rotor chamber.	▶ Check the settings. ▶ Check unhindered air circulation through the air slots. ▶ Thaw ice or switch off the centrifuge and allow it to cool down.
<b>Error 19</b>	Cooling circuit is overheated.	▶ Check unhindered air circulation through the air slots and allow the centrifuge to cool down.

Problem	Cause	Solution
Error 20	Temperature sensor in rotor chamber is faulty.	▶ Switch the centrifuge off and back on again after >20 s.
Error 21	The temperature sensor on the condenser is faulty.	▶ Switch the centrifuge off and back on again after >20 s.
Error 24	Cooling aggregate fault, e.g., overheated.	▶ Allow the centrifuge to cool down and repeat the run.

### 7.3 Emergency lid release

If the centrifuge lid cannot be opened, the emergency release can be activated manually.



**WARNING! Risk of injury from rotating rotor.**

If the emergency release of the lid is activated, the rotor may continue to rotate for several minutes.

- ▶ Wait for the rotor to stop before activating the emergency release.
- ▶ To check, look through the monitoring glass in the centrifuge lid.

1. Disconnect the mains/power plug.
2. Turn the plastic cover of the emergency lid release 90 ° counterclockwise using an appropriate tool (e.g., screwdriver) and remove it.  
The plastic cover is located on the right side of the device.
3. Insert the centrifuge rotor key in the rear hexagonal opening until a noticeable resistance is felt.
4. Turn the rotor key clockwise **while applying slight pressure**.  
This will release the centrifuge lid.
5. Open the centrifuge lid.
6. Remove the rotor key or turn the plastic covers back by turning them 90 °.



## 8 Transport, storage and disposal

### 8.1 Transport



**CAUTION! Risk of injury due to lifting and carrying of heavy loads**

The device is heavy. Lifting and carrying the device can lead to back injuries.

- ▶ Transport and lift the device with an adequate number of helpers only.
- ▶ Use a transport aid for transporting the device.

- ▶ Remove the rotor from the centrifuge before transport.
- ▶ Use the original packing for transport.

	Air temperature	Relative humidity	Atmospheric pressure
General transport	-25 °C – 60 °C	10 % – 75 %	30 kPa – 106 kPa
Air freight	-20 °C – 55 °C	10 % – 75 %	30 kPa – 106 kPa

### 8.2 Storage

	Air temperature	Relative humidity	Atmospheric pressure
In transport packing	-25 °C – 55 °C	10 % – 75 %	70 kPa – 106 kPa
Without transport packing	-5 °C – 45 °C	10 % – 75 %	70 kPa – 106 kPa

### 8.3 Disposal

If the product needs to be disposed of, the relevant legal regulations must be observed.

**Information on the disposal of electrical and electronic devices in the European Community:**

Within the European Community, the disposal of electrical devices is regulated by national regulations based on EU Directive 2012/19/EU pertaining to waste electrical and electronic equipment (WEEE).

According to these regulations, any devices supplied after August 13, 2005, in the business-to-business sphere, to which this product is assigned, may no longer be disposed of in municipal or domestic waste. To document this, they have been marked with the following marking:



Because disposal regulations may differ from one country to another within the EU, please contact your supplier if necessary.

## 9 Technical data

### 9.1 Power supply

Mains/power connection	230 V, 50 Hz – 60 Hz 120 V, 50 Hz – 60 Hz 100 V, 50 Hz – 60 Hz
Current consumption	1.4 A (230 V) 2.8 A (120 V) 3.0 A (100 V)
Power consumption	Maximum 320 W
EMC: Noise emission (radio interference)	230 V: EN 61326-1/EN55011 – class B 120 V: CFR 47 FCC Part 15 – class A 100 V: EN 61326-1/EN55011 – class A
EMC: Noise immunity	EN 61326-1 – basic electromagnetic environment
Overvoltage category	II
Fuses	250 V 2.5AT HBC (230 V) 250 V 6.3AT (120 V) 250 V 6.3AT (100 V)
Degree of pollution	2

### 9.2 Ambient conditions

Environment	For indoor use only
Ambient temperature	15 °C – 35 °C
Relative humidity	10 % – 75 %, non-condensing
Atmospheric pressure	70 kPa – 106 kPa

### 9.3 Weight/dimensions

Dimensions	Width: 29.8 cm Depth: 46.3 cm Height: 25.6 cm
Weight without rotor	22 kg
Rotor weights:	
FA-45-18-11	840 g

## 9.4 Noise level

The noise level was measured according to DIN EN ISO 3745 frontally in a sound measuring room with accuracy class 1 at a distance of 1 m from the device and at lab bench height.

Noise level	< 57 dB (A)
-------------	-------------

## 9.5 Application parameters

Tab. 9-1: Acceleration time and braking time according to DIN 58 970

Rotor	Voltage	Acceleration time	Deceleration time
FA-45-18-11	230 V	13 s	13 s
	120 V	13 s	13 s
	100 V	13 s	13 s
Run time	30 s – 1:39 h, unlimited ( $\infty$ ) 30 s – 10 min: can be set in increments of 30 s, after that in increments of 60 s.		
Temperature	0 °C to 40 °C		
Speed	100 rpm – 14000 rpm can be set in increments of 100 rpm		
Relative centrifugal force	1 × $g$ – 16876 × $g$ 1 × $g$ – 5000 × $g$ : can be set in increments of 100 × $g$ , after that in increments of 200 × $g$ .		
Maximum load	18 × 2.0 mL		
Maximum kinetic energy	2600 J		
Permitted density of the material for centrifuging (at maximum $g$ -force (rcf) or rotational speed (rpm) and maximum load)	1.2 g/mL		
Inspection obligation in Germany	no		



## 9.6 Service life of accessories



**CAUTION! Danger due to material fatigue.**

If the service life is exceeded, it cannot be guaranteed that the material of the rotors and the accessories will withstand the stresses during centrifugation.

- ▶ Do not use accessories that have exceeded their maximum service life.

Eppendorf states the maximum service life of rotors and accessories in cycles and years. The number of cycles is decisive. If determination of the number of cycles is not possible, the service life in years applies.

Each centrifugation run in which the rotor is accelerated and braked is counted as a cycle, independent of the speed and the duration of the centrifugation run.

All rotors and rotor lids can be used during the entire service life of the centrifuge if the following conditions are met:

- proper use
- recommended maintenance
- undamaged condition

Accessories	Maximum service life after initial setup
Rotor lid	3 years Prerequisite: The "click" can still be heard when tightening the rotor lid screw.
Aerosol-tight rotor lid	50 autoclaving cycles
Seals in the aerosol-tight rotor lid	50 autoclaving cycles
Adapter	1 year

The date of manufacture is stamped on the rotors and buckets in the format *2015-03* (= March 2015).



## 10 Rotors for the Centrifuge 5418 R



Eppendorf centrifuges may only be operated with rotors that are intended for use with the corresponding centrifuge.

- ▶ Only use rotors that are intended for use with the corresponding centrifuge.

Please note the manufacturer's information on the centrifugation resistance of the sample tubes used (maximum *g*-force).

### 10.1 Rotor FA-45-18-11

When using sample tubes, observe the manufacturers' information regarding centrifugation stability (max. *g*-force).

	Max. capacity	Max. g-force (rcf) or speed (rpm) without adapter	Max. load per rotor bore <sup>(1)</sup>	Notes
<b>Rotor FA-45-18-11</b>	18 tubes of 1.5/2.0 ml each or spin columns. With adapters: <ul style="list-style-type: none"> <li>• 0.2 mL PCR tubes</li> <li>• 0.4 ml/0.5 ml micro test tubes</li> <li>• 0.6 mL Microtainers</li> </ul>	16873 x g / 14000 rpm	3.75 g	• Aerosol-tight <sup>(2)</sup> rotor lid (aluminum).

(1) Maximum load per rotor bore for adapter + tube + contents.

(2) Aerosol tightness tested and certified by the Centre of Emergency Preparedness and Response, Health Protection Agency, Porton Down (UK) (see the certificate at the end of this operating manual).

### 10.1.1 rcf display and calculation



Use the **rpm/rcf** key to switch centrifugation speed display between **g-force (rcf)** and **speed (rpm)**. At speeds  $\leq 800$  rpm, only the smallest settable g-force (100 x g) is displayed when switched. You can calculate the exact g-force (rcf) with the formula provided below.

Note that the g-force (rcf) displayed when switching to the rotor without adapter is normalized. When using adapters, the following max. g-forces (rcf) can be achieved at max. speed (rpm):

Adapter	Max. centrifugation radius $r_{\max}$ [cm]	Max. g-force (rcf)
Without adapter	7.7	16873
for 0.2 mL PCR tubes	5.6	12271
for 0.4 mL micro test tubes	7.7	16873
for 0.5 mL micro test tubes	6.6	14462
for 0.6 mL Microtainers	7.7	16873

To determine the g-force (rcf) for a special adapter, you can perform a calculation according to DIN 58970 with the following formula:

$$\text{rcf} = 1.118 \cdot 10^{-5} \cdot n^2 \cdot r_{\max}$$

n: Revolutions per minute (rpm)

$r_{\max}$ : Max. centrifugation radius in cm

#### Example:

The 0.2 mL adapter has a maximum radius of 5.6 cm. At 5000 rpm, a maximum g-force of 1565 x g is achieved.

## 11 Ordering information

### 11.1 Accessories

Order no. (International)	Description
5418 707.005	<b>Rotor FA-45-18-11</b> aerosol-tight, angle 45°, 18 places, max. tube diameter 11 mm, incl. rotor lid (aluminum)
5418 708.001	<b>Rotor lid for FA-45-18-11</b> aerosol-tight, aluminum
5418 709.008	<b>Seal for rotor lid</b> FA-45-18-11 (5418/5418 R), FA-45-6-30 (5804/5804 R/5810/5810 R), FA-6x50 (5910 R, 5920 R) 5 pieces
5425 715.005 5425 717.008 5425 716.001	<b>Adapter</b> used in FA-45-18-11 for 1 PCR tube (0.2 mL, max. Ø 6 mm), set of 6 for 1 micro test tube (0.4 mL, max. Ø 6 mm), set of 6 for 1 sample tube (0.5 mL, max. Ø 6 mm) or 1 Microtainer (0.6 mL, max. Ø 8 mm), set of 6
5416 301.001	<b>Rotor key</b> Standard
5401 850.076	<b>Tray for condensation water</b>

\*) Aerosol impermeability tested and certified by the Centre of Emergency Preparedness and Response, Health Protection Agency, Porton Down (UK).

### 11.2 Fuses

Order no. (International)	Description
5425 351.003 5426 355.100	<b>Fuse</b> 2.5 A T (230 V), set of 2 6.3 AT (100 V/120 V), set of 2

**Ordering information**

Centrifuge 5418 R  
English (EN)

# Declaration of Conformity

The product named below fulfills the requirements of directives and standards listed. In the case of unauthorized modifications to the product or an unintended use this declaration becomes invalid. This declaration of conformity is issued under the sole responsibility of the manufacturer.

**Product name:**

Centrifuge 5418 R  
including components

**Product type:**

Centrifuge

**Relevant directives / standards:**

2006/42/EC: EN ISO 12100  
2014/35/EU: EN 61010-1, EN 61010-2-020  
UL 61010-1, CAN/CSA C22.2 No. 61010-1, IEC 61010-2-020  
2014/30/EU: EN 61326-1, EN 55011  
47 CFR FCC part 15  
2011/65/EU: EN 50581  
2014/68/EU: EN 378-1, EN 378-2

Person authorized to compile  
the technical file acc. to 2006/42/EC: Dr. Reza Hashemi  
Executive Director Portfolio Management Centrifugation  
Eppendorf AG

Hamburg, October 13, 2017



Dr. Wilhelm Plüster  
Management Board



Dr. Reza Hashemi  
Portfolio Management

Your local distributor: [www.eppendorf.com/contact](http://www.eppendorf.com/contact)  
Eppendorf AG · Barkhausenweg 1 · 22339 Hamburg · Germany  
[eppendorf@eppendorf.com](mailto:eppendorf@eppendorf.com)

Eppendorf® and the Eppendorf Brand Design are registered trademarks of Eppendorf AG, Germany.  
All rights reserved, incl. graphics and pictures. Copyright ©2017 by Eppendorf AG.

[www.eppendorf.com](http://www.eppendorf.com)

ISO  
9001  
Certified

ISO  
13485  
Certified

ISO  
14001  
Certified

5401 900.928-00

# CERTIFICATE OF COMPLIANCE

**Certificate Number** 2018-6-21-E215059  
**Report Reference** E215059-D1006-1/A0/C0-UL  
**Issue Date** 2018-6-21

**Issued to:** EPPENDORF AG  
**Applicant Company:** BARKHAUSENWEG 1  
22339 HAMBURG  
GERMANY

**Listed Company:** Same as applicant

**This is to certify that representative samples of** Centrifuge  
5401 (5418R)

Have been investigated by UL in accordance with the Standard(s) indicated on this Certificate.

**Standard(s) for Safety:** UL 61010-1, 3rd Edition, May 11, 2012, Revised April 29 2016, CAN/CSA-C22.2 No. 61010-1-12, 3rd Edition, Revision dated April 29 2016

**Additional Standards:** IEC 61010-2-020, 3rd. Ed.

**Additional Information:** See the UL Online Certifications Directory at [www.ul.com/database](http://www.ul.com/database) for additional information.

Only those products bearing the UL Certification Mark should be considered as being covered by UL's Certification and Follow-Up Service.

Look for the UL Certification Mark on the product.

This is to certify that representative samples of the product as specified on this certificate were tested according to the current UL requirements.

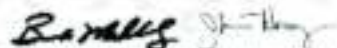

Bruce Mahrenholz, Assistant Chief Engineer, Global Inspection and Field Services, UL LLC  
Joseph Hisey, General Manager, Director of Sales - Canada, UNDERWRITERS LABORATORIES OF CANADA INC.

Any information and documentation involving UL Mark services are provided on behalf of UL LLC (UL) or any authorized licensee of UL. For questions, please contact a local UL Customer Service Representative [www.ul.com/contact](http://www.ul.com/contact)







## Certificate of Containment Testing

Containment Testing of Rotor  
FA 45-18-11 (5418 707.102-02, 50 x  
autoclaved at 121°C for 20 minutes)  
Eppendorf Centrifuge 5418 / 5418R

Report No. 73-08 C

**Report prepared for:** Eppendorf AG, Hamburg, Germany  
**Issue Date:** 10<sup>th</sup> March 2008 (amended 24<sup>th</sup> Sept 2009)

### Test Summary

Rotor FA 45-18-11 (5418 707.102-02, 50 x autoclaved at 121°C for 20 minutes) was containment tested in the Eppendorf 5418 / 5418R centrifuge, using Annex AA of IEC 1010-2-20. The rotor was shown to contain a spill within the rotor.

**Report Written By**

Anna May

**Report Authorised By**

[Signature]





