

FatExtractor E-500

Technical data sheet

The declaration of the total fat or crude fat is required for most foods and feeds. The FatExtractor E-500 is designed for solid-liquid extraction for quick and compliant fat determination. The design of the glass assemblies and the high-speed heaters combined with sophisticated process control allow for the fastest and most reproducible extraction processes with full compliance.

By simply changing the glass assembly, the FatExtractor E-500 complies with standard methods such as Soxhlet, Hot Extraction (HE) or Twisselmann (ECE). The glass assembly is interchangeable for a later conversion to another extraction method. Suitable for extractions with petroleum ether, diethyl ether, hexane or chloroform.

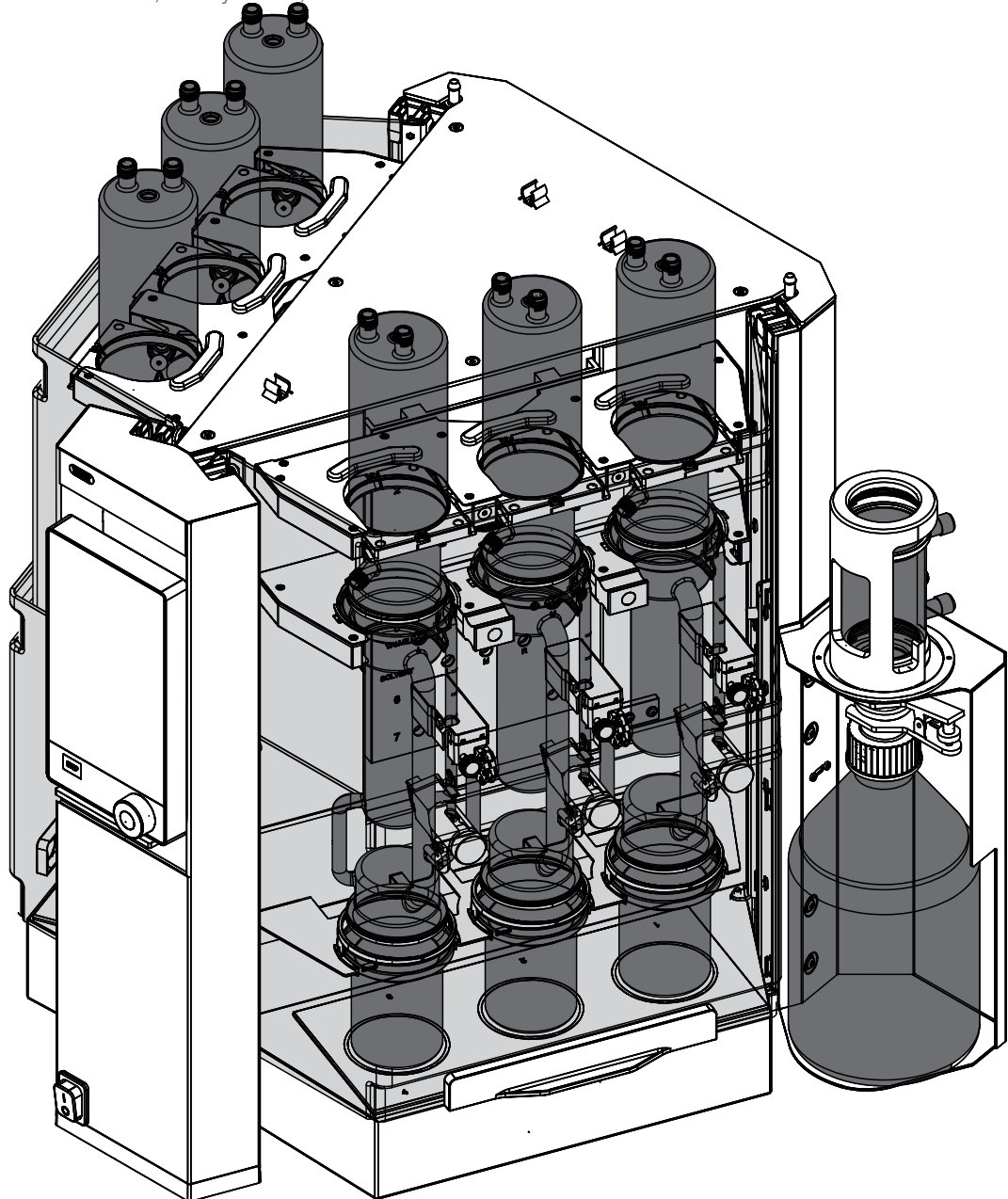

Description of function

The FatExtractor E-500 is designed to carry out the following solid-liquid extraction methods:

- Soxhlet Extraction (see Chapter "Soxhlet Extraction")
- Hot Extraction (see Chapter "Hot Extraction")
- Economic Continuous Extraction (see Chapter "Economic Continuous Extraction")

Soxhlet Extraction

Step 1: Extraction

- The sample is located in the extraction chamber.
- The beaker contains the solvent.
- The solvent is heated, vapor rises up to the condenser, condenses and drops into the extraction chamber with the sample.
- The magnetic valve is closed, the solvent is collected up to the optical sensor and extracts the analyte.
- When the optical sensor is reached, the magnetic valve opens and the solvent containing the analyte flows back into the beaker.

Step 2: Rinsing

- The solvent is heated, vapor rises up to the condenser, condenses and drops into the extraction chamber with the sample.
- The magnetic valve is open, the solvent flows back into beaker, the solvent is not collected.

Step 3: Drying

- The solvent is heated, vapor rises up to the condenser, condenses and flows into tank.
- The analyte remains in the beaker.

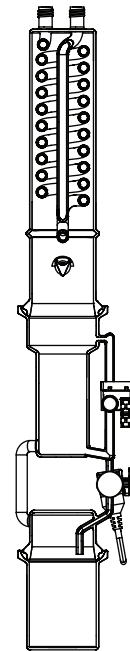

Hot Extraction

Step 1: Extraction

- The sample is located in the beaker.
- The beaker contains the solvent.
- The solvent is heated, vapor rises up to the condenser, condenses and drops into the beaker with the sample.

Step 2: Rinsing

- The solvent in the beaker is heated up and evaporated.
- The vapor rises up to the condenser.
- The condensed solvent flows into the beaker with the sample.
- The tank bottle valve opens periodically and condensed solvent flows in the tank bottle.
- The solvent level decreases.

Step 3: Drying

- The solvent is heated, vapor rises up to the condenser, condenses and flows into tank.
- The analyte remains in the beaker.

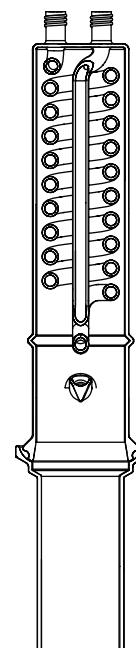

Economic Continuous Extraction

Step 1: Extraction

- The sample is located in the extraction chamber.
- The beaker contains the solvent.
- The solvent is heated, vapor rises up around the sample to the condenser, condenses and drops back into extraction chamber through the sample into the beaker.

Step 2: Drying

- The solvent is heated, vapor rises up around the sample to the condenser, condenses and flows into tank.
- The analyte remains in the beaker.

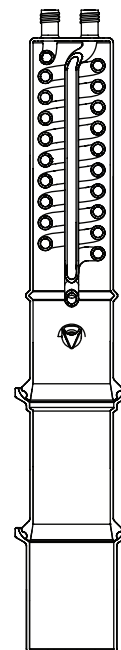

Order code FatExtractor E-500

The FatExtractor E-500 can be ordered in the following configurations: Soxhlet, Hot Extraction (e.g. Randall) or Economic Continuous Extraction (e.g. Twisselmann). For large sample volumes, use the Soxhlet LSV version, suitable for extraction thimbles with a diameter of 43 mm.

The FatExtractor E-500 can be upgraded with the Analyte protection sensor for increased user safety and to prevent any loss of analyte during the extraction process. The Pro Interface consists of a 7 inch color touch display for even more intuitive use and overview on the interface.

For environmentally friendly operation the FatExtractor E-500 can be bundled with Recirculating Chiller F-305/F-308 for saving cooling water. The FatExtractor E-500 has to be operated either with a recirculating chiller or a tap water valve.

Choose the configuration according to your needs:

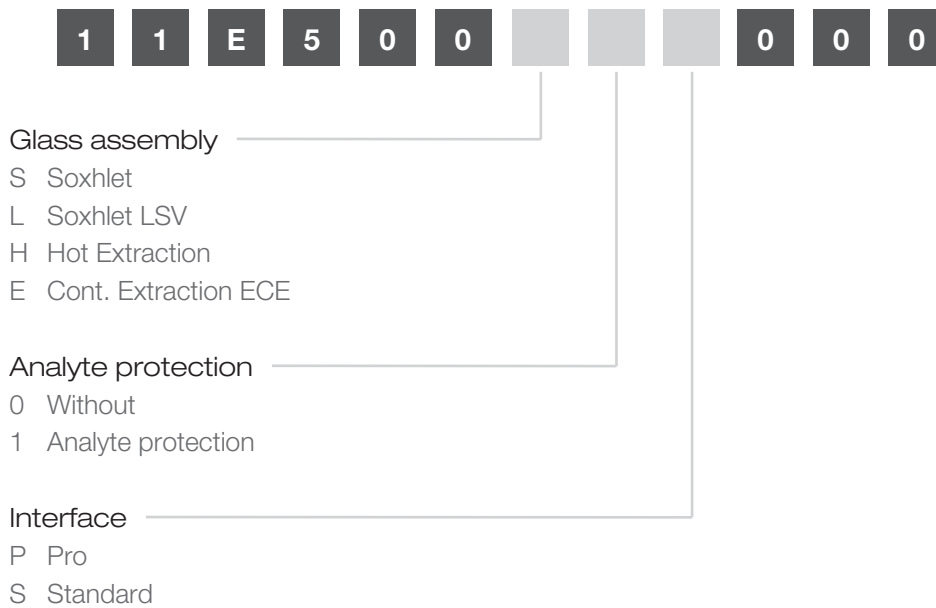

Order code FatExtractor E-500 System

The FatExtractor E-500 can be bundled with the HydrolEx H-506 for total fat determination and a Recirculating Chiller F-305/F-308.

HydrolEx H-506 performs convenient and safe acid hydrolysis as a step prior to extraction. It is an essential work step of the total fat determination where matrix structures enclosing the fat fraction of food and feed samples are broken up.

For environmentally friendly operation the FatExtractor E-500 can be bundled with Recirculating Chiller F-305/F-308 for saving cooling water. The FatExtractor E-500 has to be operated either with a recirculating chiller or a tap water valve.

Choose the configuration according to your needs:

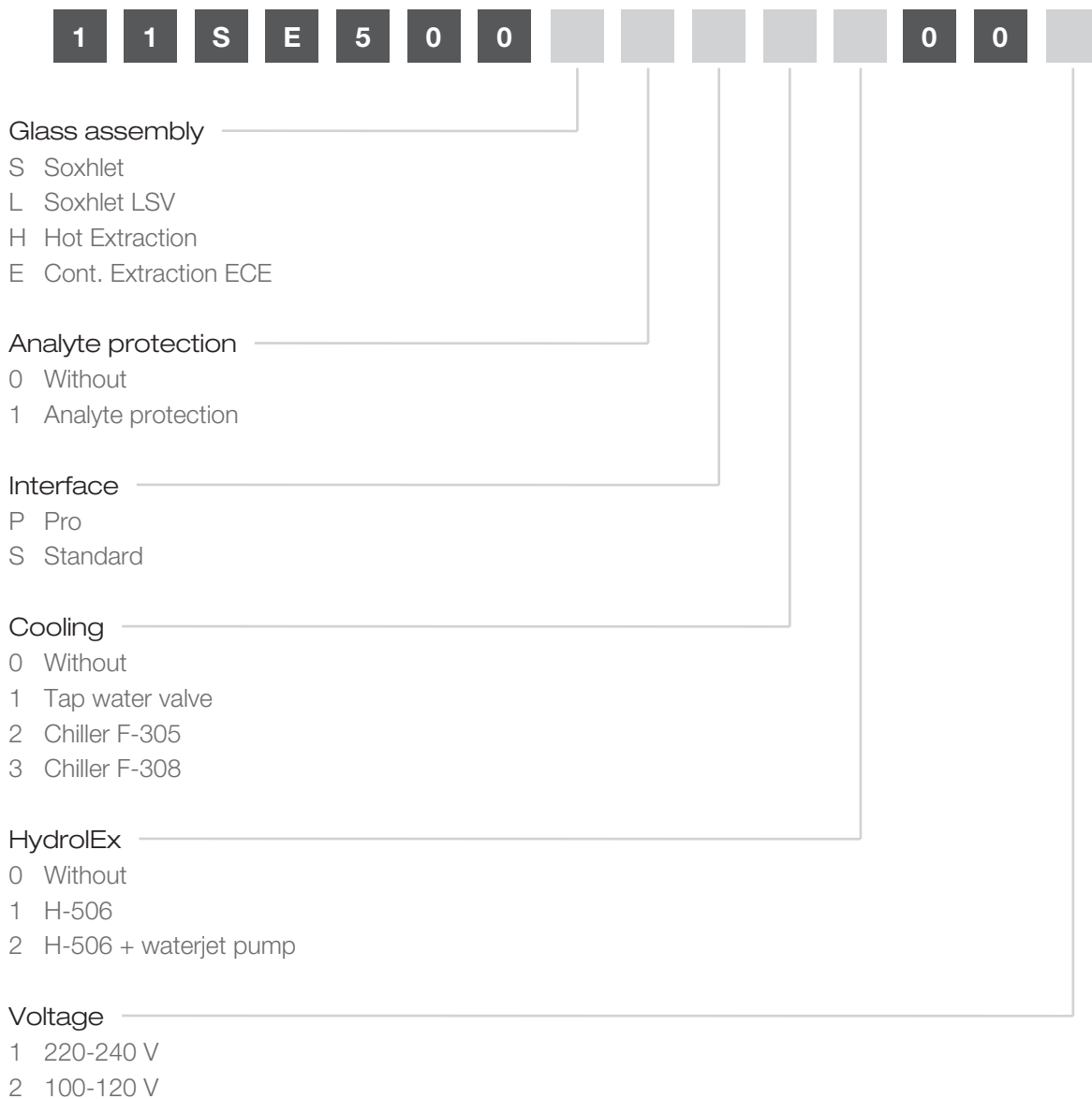

Scope of delivery

All configurations are supplied ready to use.

	Hot Extraction	Economic Continuous Extraction	Soxhlet Extraction	Soxhlet Extraction LSV
FatExtractor E-500	1	1	1	1
Condenser E-500	6	6	6	6
Extraction glass chamber ECE	-	6	-	-
Extraction glass chamber Soxhlet	-	-	6	-
Extraction glass chamber Soxhlet LSV	-	-	-	6
Soxhlet assembly cpl.	-	-	6	6
Extraction beaker	-	6	6	6
Extraction beaker HE	6	-	-	-
Sealing E-500	6	12	12	12
Set of glass sample tube holder (3 pcs.)	2	2	2	-
Set of glass sample tube holder LSV (3 pcs.)	-	-	-	2
Set of holders for thimbles 25 mm (3 pcs.)	2	2	2	-
Set of holders for thimbles 33 mm (3 pcs.)	2	2	2	2
Set of holders for thimbles 43 mm (3 pcs.)	-	-	-	2
Extraction thimbles 25 x 100 mm	6	6	6	-
Extraction thimbles 33 x 94 mm	6	6	6	6
Extraction thimbles 43 x 118 mm	-	-	-	6
Solvent tank cpl.	1	1	1	1
Cooling water hose 3 m	2	2	2	2
Beaker tong	1	1	1	1
Extraction beaker carrier	-	1	1	1
Extraction beaker carrier HE	1	-	-	-
Funnel	1	1	1	1
Power cord	1	1	1	1

	Hot Extraction	Economic Continuous Extraction	Soxhlet Extraction	Soxhlet Extraction LSV
Pliers for glass sample tube with frit	1	1	1	1
Operation manual	1	1	1	1

Technical data

FatExtractor E-500

Specification	E-500
Power consumption	1300 W
Connection voltage	100 - 240 ± 10 % VAC
Fuse	10 A
Frequency	50 / 60 Hz
Overvoltage category	II
Pollution degree	2
Protection Class	1
Dimensions (W x D x H) (with glassware Soxhlet Extraction)	638 x 595 x 742 mm
Dimensions (W x D x H) (with glassware Hot Extraction)	638 x 595 x 613 mm
Dimensions (W x D x H) (with glassware Economic Continuous Extraction)	638 x 595 x 622 mm
Minimum clearance (W x D)	200 mm
Minimum clearance (H)	500 mm
Weight (without glassware)	41.8 kg
Weight (with glassware Soxhlet Extraction)	49.6 kg
Total heating power (rated)	600 W
Total heating power (maximum)	1200 W
Hose connection	6 / 9 mm
Minimum water flow	100 mL/min
Allowed water pressure (nominal value)	6 bar
Allowed water pressure (maximum)	8 bar
Inlet cooling medium temperature	25 °C below the boiling point of the solvent
Number of extraction positions	6
Solvent tank volume	2 L

Specification	E-500
Max. filling level (Extraction glass chamber Soxhlet)	120 mL
Max. filling level (Extraction glass chamber Soxhlet LSV)	195 mL
Max. working volumes (Beaker)	175 mL
Max. working volumes (Beaker HE)	100 mL
Language	DE, EN, IT, ES, FR, JA, CN, PL, RU
Method storage (Interface)	20 methods
Method storage (Pro interface)	40 methods

Ambient conditions

For indoor use only.

Max. altitude above sea level	2000 m
Ambient temperature	5–40 °C
Maximum relative humidity	80% for temperatures up to 31 °C decreasing linearly to 50 % relative humidity at 40 °C
Storage temperature	max. 45 °C

Conversion and upgrade kits

The FatExtractor E-500 can be converted into another configuration with an easy change of glass assembly. Choose the needed conversion kit according to the matrix.

from to	Soxhlet Extraction	Hot Extraction	Economic Continuous Extraction	Soxhlet Extraction LSV
Soxhlet Extraction		11068489	11068492	
Hot Extraction	11068487		11068487	11068487
Economic Continuous Extraction	11068488	11068491		11068488
Soxhlet Extraction LSV		11068490	11068493	

	Order no.
Conversion kit from Soxhlet / ECE to HE incl.: 6 beakers HE (3 x 11067475) , beaker brackets HE (2 x 11067829), set of draining tubes for HE (11067480), beaker carrier cover for HE	11068487
Conversion kit from Soxhlet / Universal to ECE Includes 6 Extraction glass chamber ECE (11062499), set of draining tubes for ECE (11067479)	11068488
Conversion kit from HE to Soxhlet Includes 6 Extraction glass chamber Soxhlet (11062496), 6 beaker (3 x 11067474), 6 beaker brackets (2 x 11067828), 6 Soxhlet assemblies cpl. (11067065) and a chamber rack (11067077), set of draining tubes for Soxhlet (11067478), two safety shields top, cpl. (2 x 11067832)	11068489
Conversion kit from HE to ECE Includes 6 Extraction glass chamber ECE (11062499), 6 beaker (3 x 11067474), 6 beaker brackets (2 x 11067828), set of draining tubes for ECE (11067479) and a chamber rack (11067077)	11068491
Conversion kit from ECE to Soxhlet Includes 6 Extraction glass chamber Soxhlet (11062496), 6 Soxhlet assemblies cpl. (11067065) and set of draining tubes for Soxhlet (11067478), two safety shields top, cpl. (2 x 11067832)	11068492
Conversion kit HE to Soxhlet LSV Includes 6 Extraction glass chamber Soxhlet LSV (11062497), 6 beaker (3 x 11067474), 6 beaker brackets (2 x 11067828), 6 Soxhlet assemblies cpl. (11067065) and a chamber rack (11067077), set of draining tubes for Soxhlet (11067478), two safety shields top, cpl. (2 x 11067832)	11068490
Conversion kit ECE to Soxhlet LSV Includes 6 Extraction glass chamber Soxhlet LSV (11062497), 6 Soxhlet assemblies cpl. (11067065) and a set of draining tubes for Soxhlet (11067478), two safety shields top, cpl. (2 x 11067832)	11068493

	Order no.
Upgrade kit Analyte protection For later upgrade of a FatExtractor E-500 with analyte protection sensor	11068524
Upgrade kit Interface Pro For later upgrade of a FatExtractor E-500 with a Pro interface (7 " touch screen)	11068525

Chiller

No. Units	Ambient Temperature	Chiller
1	< 30 °C	Recirculating Chiller F-305
1	< 40 °C	Recirculating Chiller F-308
2	< 30 °C	Recirculating Chiller F-308
2	< 40 °C	Recirculating Chiller F-314

	Order no.
Recirculating Chiller F-305 550 W at 15 °C, Display, 230 V	11F30501
Recirculating Chiller F-305 550 W at 15 °C, Display, 115 V	11F30502
Recirculating Chiller F-308 900 W at 15 °C, Display, 230 V Cooling capacity 900 W at 15 °C, for temperatures from -10 to 25 °C	11F30801
Recirculating Chiller F-308 900 W at 15 °C, Display, 115 V Cooling capacity 900 W at 15 °C, for temperatures from -10 to 25 °C	11F30802
Recirculating Chiller F-314 1400 W at 15 °C, Display, 230 V Cooling capacity 1400 W at 15 °C, for temperatures from -10 to 25 °C	11F31401
Recirculating Chiller F-314 1400 W at 15 °C, Display, 115 V Cooling capacity 1400 W at 15 °C, for temperatures from -10 to 25 °C	11F31402

Spare parts

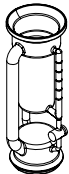
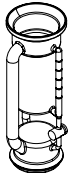
	Order no.	Image
Extraction glass chamber Soxhlet	11062496	
Extraction glass chamber Soxhlet LSV	11062497	

	Order no.	Image
Extraction glass chamber ECE	11062499	
Set of beakers, 2 pcs.	11067474	
Set of beakers HE (2pcs)	11067475	
Condenser E-500 cpl.	11067063	
Condenser flange E-500	11067817	
Condenser tank bottle	11065966	
Tank adapter, PTFE	11064590	
Tank bottle 2 L, GL 45	11070509	
Set of gliding elements including magnets, 10 pcs.	11067827	

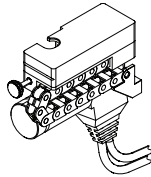
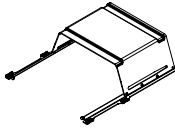
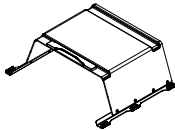
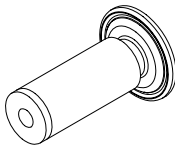
	Order no.	Image
Soxhlet assembly cpl. One part consisting of magnetic valve and level sensor for extraction glass chamber Soxhlet	11067065	
Protection shield top, cpl.	11067832	
Protection shield bottom, cpl.	11067831	
Set of seals E-500, FKM, 6 pcs.	11069012	
Membrane with anchor for magnetic valve unit	037534	
Joint clip	11070136	
Set of beaker brackets, 3 pcs.	11067828	
Set of beaker brackets HE, 3 pcs.	11067829	
Reflectorfoil analyte protection, 6 pcs.	11068522	
Knurled nut and sealing disks, 2 pcs. Connection of the draining tubes to the condensers	11068520	
Set of flange locks, 6 pcs.	11067833	
Silicone hose D6/9 L=3 m	048355	
Set of draining tubes SOX, FEP	11067478	
The draining tubes connect the receiving funnel in the condensers with the tank valve to drain solvent into the tank.		
Set of draining tubes HE, FEP	11067480	
The draining tubes connect the receiving funnel in the condensers with the tank valve to drain solvent into the tank.		
Set of draining tubes ECE, FEP	11067479	

Accessories

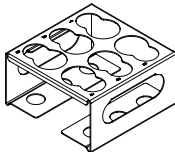
	Order no.	Image
Holder for glass sample tubes, stainless steel	11067219	

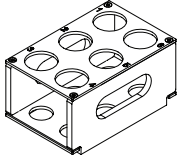
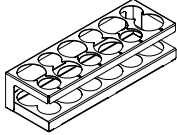
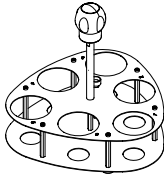
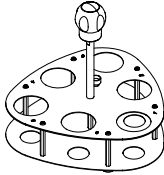
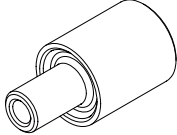
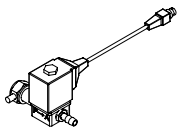
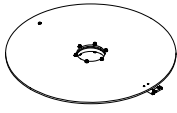
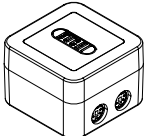



	Order no.	Image
Holder for glass sample tubes, PTFE	11067220	
Holder for extraction thimbles (diameter 25 - 43 mm)	11068443	
Extraction beaker carrier Allows to carry 6 beakers (11067474)	11067042	
Extraction beaker HE carrier Allows to carry 6 beakers HE (11067475)	11067493	
Set condenser insulations E-500, 6 pcs. The insulation of the condensers prevent condensing water and is recommended in high humidity environment	11069078	
Set insulation cooling water hoses The insulation of the water hoses prevent condensing water and is recommended in high humidity environment.	11069079	
Support solvent supply Allows to fix the tubes of solvent dispensers to the condensers for convenient solvent addition.	11068306	
Cooling water valve. 24VAC Valve opens cooling water feed during distillation. Meant to be used with a vacuum controller/interface.	031356	
Extension cable for the cooling water valve, 2 m	11069477	
Turning disk Allows for turning the instrument for easier access.	11067985	
StatusLight cpl., incl. communication cable Indicates the status of the instrument (instrument is ready to use, has an error or is in operation).	11068959	

	Order no.	Image
Funnel	11067473	

Consumables

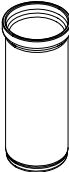
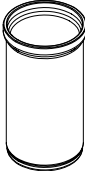
	Order no.
Quartz sand 0.3 - 0.9 mm, 2.5 kg	037689
Celite® 545, 1 kg	11068920

Glass sample tubes and extraction thimbles

	Order no.	Image
Glass sample tubes with frit, 6 pcs. Working volume: 64 mL Filling volume: 82 mL	11067497	
Glass sample tubes LSV with frit, 6 pcs. Working volume: 116 mL Filling volume: 144 mL	11067814	
Extraction thimbles 25 x 100 mm, 25 pcs. Working volume: 44 mL	018105	
Extraction thimbles 33 x 94 mm, 25 pcs. Working volume: 64 mL	11058983	
Extraction thimbles, Set. 25 pcs, 43 x 118 mm, cellulose For Soxhlet extraction unit. Working volume: 150 mL	018106	

Holder for extraction thimbles

	Order no.
Set of holders for glass sample tubes with frit, PTFE, 3 pcs.	11067485
Set of holders for LSV glass sample tubes, PTFE, 3 pcs.	11067486
Holders for thimbles d25, PTFE, 3 pcs.	11067488
Holders for thimbles d33, PTFE, 3 pcs.	11067490
Holders for thimbles d43, PTFE, 3 pcs.	11067491

Documentation

	Order no.
IQ/OQ for FatExtractor E-500	11068557
Installation/Operation qualification for the FatExtractor E-500 incl. binder with documents IQ/OQ, inspection and basic tag (English)	
Repeating OQ for FatExtractor E-500	11068559
Repeating operation qualification for FatExtractor E-500, incl. document, inspection and basic tag (English)	