

eppendorf

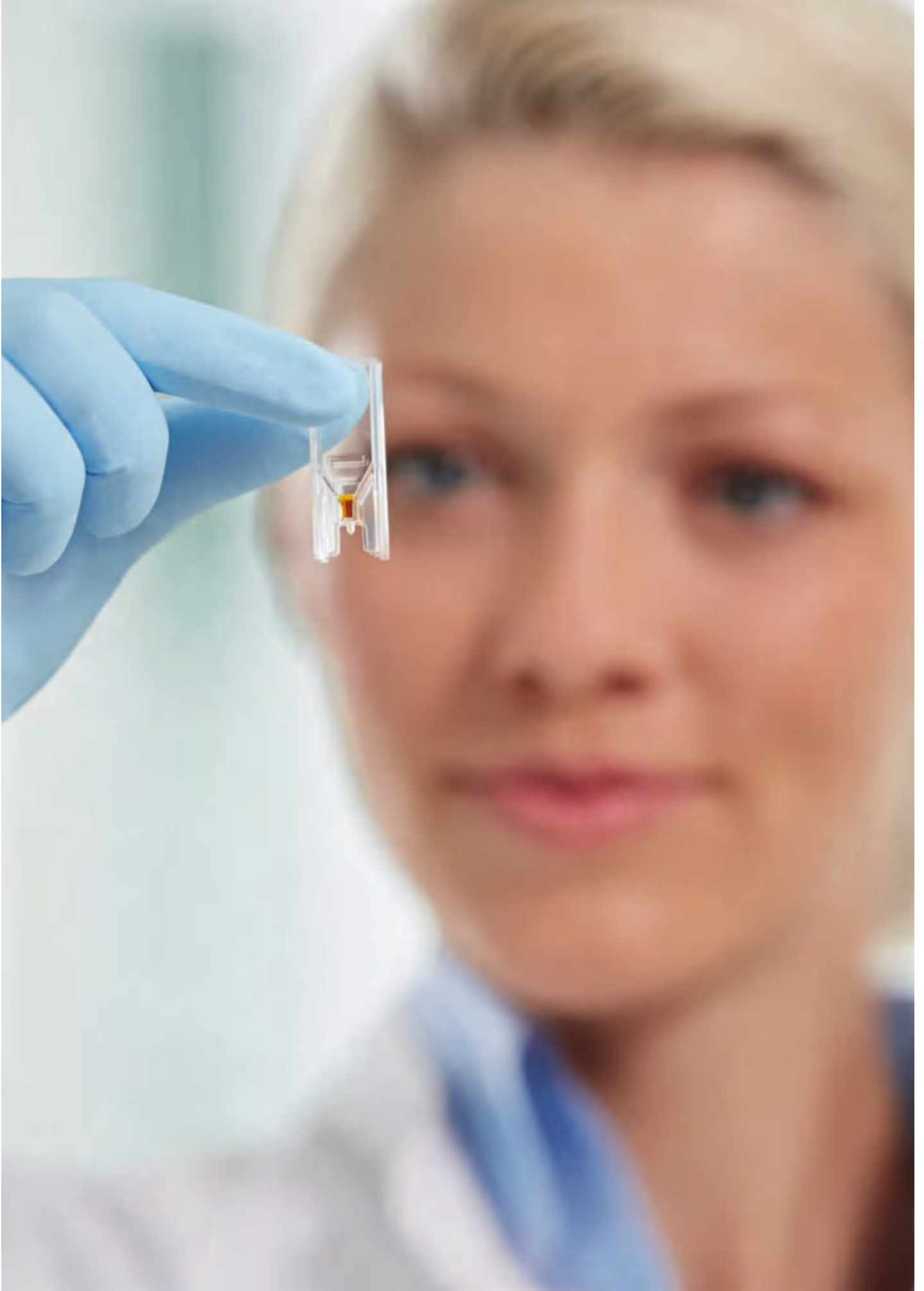

Spark of the Future

Spectracular performance
Eppendorf photometer and accessories



»You might got your basic training in the laboratory with one of ours....«

Nearly 70 years ago, we installed our first photometers in labs. From the very beginning, our focus was on obtaining maximum benefits for the user while using the most convenient handling methods. Later on, we called this Eppendorf PhysioCare Concept®. Take advantage of our expertise in detection by achieving optimum results in your laboratory.



Discover new possibilities

- > Lowest sample volume
- > Combine UV/Vis and fluorescence methods by using the BioSpectrometer fluorescence
- > Sensitive sample quantification beyond the photometric detection limit

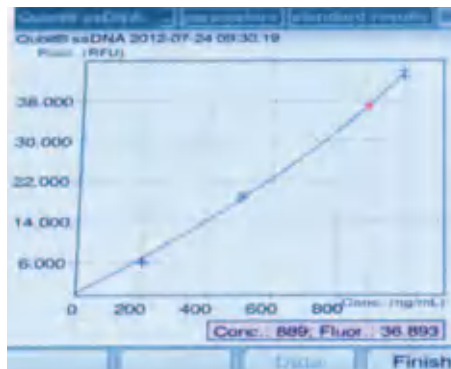

Make your data work easier

- > Preprogrammed applications for a quick start and minimal errors
- > Automatic evaluation of data and convenient presentation of results for fast processing
- > Data storage within the instrument or easy data export for data security



Be flexible in measurements

- > UV-transparent plastic cuvettes as well as special microliter measuring cells to cover all common photometric applications
- > Valuable sample material stays safe due to certified purity grades

UV-Vis Samples

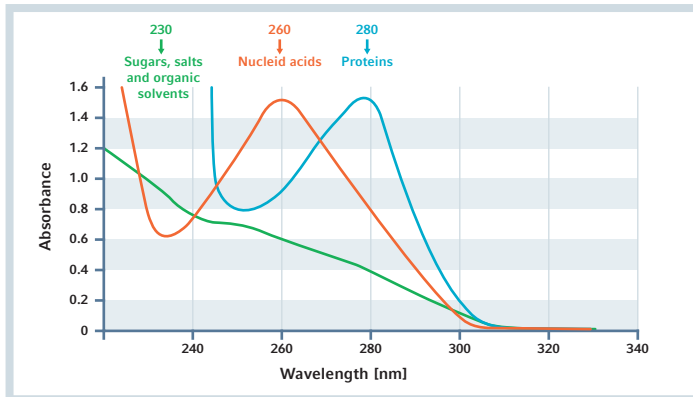

Absorbance spectra of nucleic acids and possible contaminations

Quantification of nucleic acids can be performed by measuring absorbance at a wavelength of 260 nm in a UV-Vis (spectro-)photometer. The OD₂₆₀ value is used to calculate the concentration, using the sample specific factor, of the nucleic acid sample.

OD₂₆₀ = 1*: 50 µg/ mL double strand DNA
 40 µg/ mL RNA
 33 µg/ mL single strand DNA

* 1 cm path length

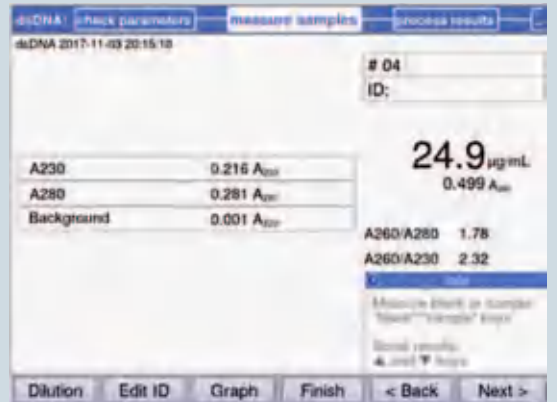
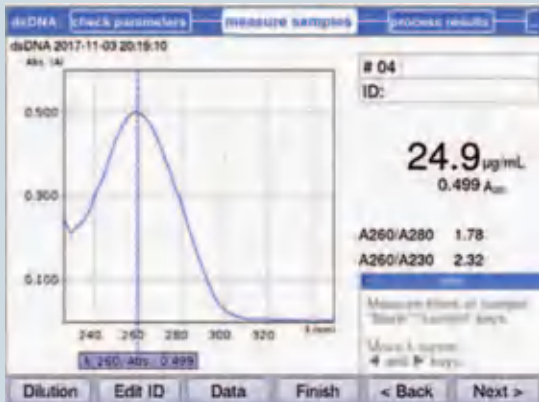

Different result screens for easy handling



Transmission Samples

In addition to absorbance or concentration, photometric measured values can also be displayed as transmission:



What else besides the concentration of your sample of interest?

Sample purity can be estimated by measuring the sample at further wavelengths (230 nm, 280 nm). The purity can be calculated by the ratios of the values obtained at 260/230 nm and at 260/280 nm, respectively.

These ratios may indicate whether proteins or remains of reagents used during upstream steps are still present in your sample. They generate a different absorbance spectrum from nucleic acids.

Turbidity measurements, frequently conducted at 320 nm, are capable of detecting particles within the sample. A scan covering the entire UV spectrum will provide even more information on impurities.

$OD_{260}/OD_{280} = 1.8$ for clean DNA
 $OD_{260}/OD_{280} = 2.0$ for clean RNA

Transmission is calculated from the ratio of I (light leaving the cuvette) and I_0 (light entering the cuvette) and expressed in percent as %T.

As an alternative data output to absorbance or concentration, the pre-programmed method »Transmission« of BioPhotometer D30 and BioSpectrometers provides you the percentage transmission of the sample.

When using the »Transmission« method, the light transmittance of the sample is given as T% instead of the absorbance, which is directly used to calculate the sample concentration. These raw data can also be used as a basis for further own calculations.

$$T = I/I_0$$

$$\%T = I/I_0 * 100$$

The photometer automatically calculates the absorbance (A) from the measured transmission (T).

$$A = -\log_{10} T = \lg(I_0/I)$$

Fluorescence Samples

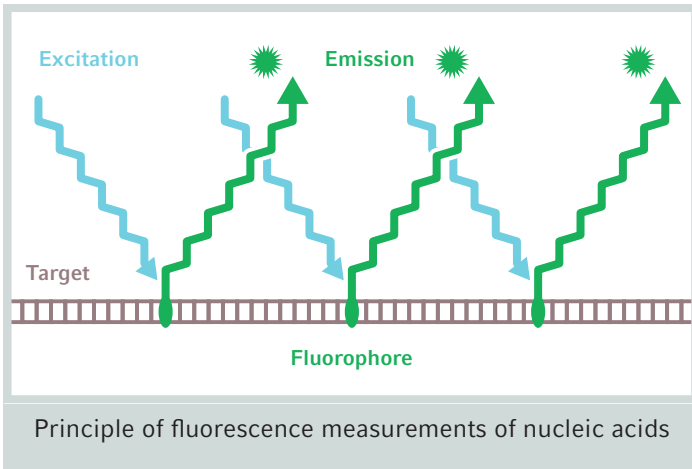

UV-based quantification of nucleic acids has limits which can be bypassed by using fluorescence detection, qPCR, or chip-based capillary electrophoresis systems.

The amount of nucleic acid is calculated based on the intensity of the fluorescent signal. For excitation and detection, fluorimeter or a photometer with a fluorescence module is required.

Nucleic acids quantification via fluorescence is based on fluorescent dyes which bind to the nucleic acids. Only the complex consisting of nucleic acid and dye is excited by light of a specific wavelength (dependent on the dye) and will subsequently emit light of a slightly longer wavelength.

Workflow Fluorescence Measurements

Transfer of sample
 > Fill sample into cuvette



Light-sensitivity
 > Fluorescent dyes as well as fluorescence-labeled samples should be stored in amber vessels to reduce bleaching of the dye

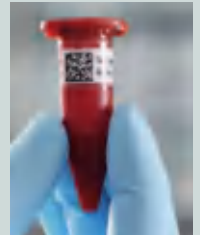

Generate standard curve
 > Measure blank and standards
 > Choose regression mode

Standard	Conc. (ng/mL)	Fluorescence (RFU)
Standard 1	0	0.00
Standard 2	100	32.4
Standard 3	200	29.7
Standard 4	500	54.2

Determine sample concentration
 > Measure samples
 > Calculate concentration

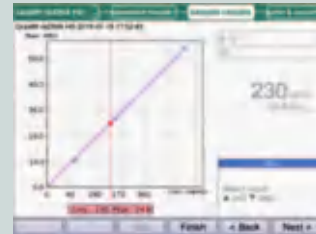
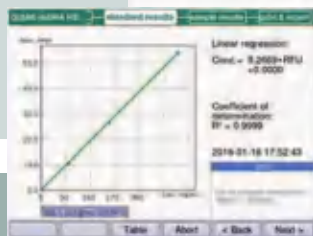

Kinetic Process

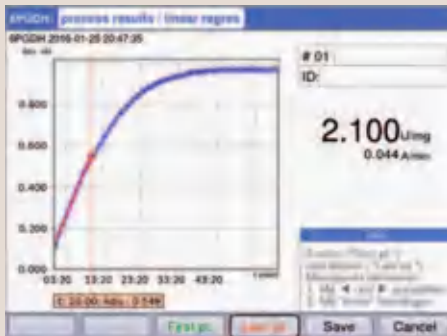

Linear regression analysis of an enzyme activity measurement with adjustment of start and end point.

The enzymatic activity measurements quite often need to be performed at a specific temperature. For reducing measurement variations, the cuvette shaft of the spectrometer needs to be temperature-controlled. Enzyme activity [U/mg] can be done time-consuming by hand or by fast calculation of the spectrometer. Software based »linear regression« is useful for the accurate definition of the linear range of a kinetic measurement.

When do I need what?

Depending on the sample concentration, different photometric approaches are recommended:

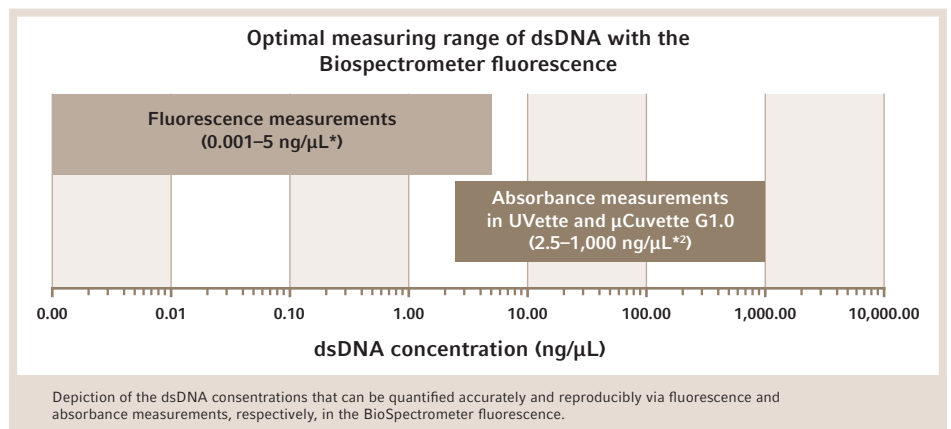

Absorbance

- > Quick and easy as this is a direct method of measurement
- > Non-hazardous and very stable as no chemicals are required
- > Provides information on sample purity

Fluorescence

- > High sensitivity; therefore ideally suited to the analysis of samples of low concentration and saving of valuable sample material
- > High accuracy due to high specificity for the target molecule

Kinetic

- > Measurement over time including reliable temperature control of reactions by cuvette shaft with integrated peltier element
- > Time-saving processing which allows the adaption of the time window after measurement including statistical data on curve fit

Ergonomics ...

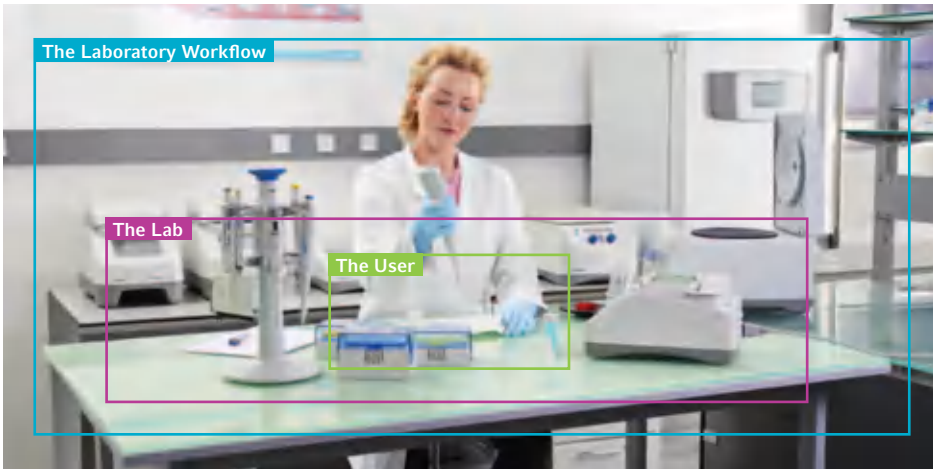

Eppendorf PhysioCare Concept
 The ideal Eppendorf product fulfilling the PhysioCare concept provides a comprehensive approach for the user. Starting with an ergonomic design of the product itself (e.g. smooth shape, low weight, low needed forces, intuitive user interface,...), fitting into an ergonomic work space and finally supporting an optimal workflow within the lab.

Sphere 1 – The User
 Addressing the direct interaction between you and the product. Ergonomic design and product alignment optimized to the needs of the individual.

Sphere 2 – The Lab
 Addressing the interaction at your workspace, resulting in a good interaction within your workflow.

Sphere 3 – The Laboratory Workflow
 General support to enhance processes around the lab and the whole company or institute.

... for Detection



Just one »zzzt« from your result: Guided handling for easy processing of your samples



Left, right, up, down?
 Clear indications for convenient handling

Don't spill your valuable samples: Stable cuvette holder



Guided touchdown:
 Hydrophobic surface coating on quartz glass

Spectracular Performance



One Will Fit to Your Needs

UV-Vis is your standard?

The Eppendorf BioPhotometer D30 is the third generation of Eppendorf's well-established BioPhotometers. Small, clearly processed data volumes make evaluating results fast and simple. For specific methods, additional measurement data will be recorded in a defined measuring range and displayed extrapolated, making impurities in the sample easier and quicker to identify.

Product benefits

- > 10 fixed wavelengths between 230 nm and 600 nm
- > Display of purity scans (extrapolated measurement data) for specific applications (nucleic acids and proteins)
- > All relevant ratios are automatically determined for a method
- > Spectral bandwidth of ≤ 4 nm for optimal measurement of biomolecules (e.g. DNA, RNA, proteins)

You need a scan?

With the Eppendorf BioSpectrometer basic, measurements can be executed in the UV and Vis range from 200 nm to 830 nm. The freely selectable wavelengths offer you maximum flexibility during these procedures. Optimized menu navigation guides you through the individual methods in a step-by-step process. All required entries are visible right away.

Product benefits

- > UV/Vis spectral range of 200 nm to 830 nm for flexible applications
- > Advanced methods (e.g. multiwavelength detection, dual wavelength subtraction/division, incorporation of fluorescence dyes)

Eppendorf BioPhotometer® D30



Eppendorf BioSpectrometer® basic

Eppendorf BioSpectrometer® kinetic



Eppendorf BioSpectrometer® fluorescence

Measuring live enzymatic reactions?

The Eppendorf BioSpectrometer kinetic offers a temperature-controlled cuvette shaft for time-curve experiments. The integrated peltier element guarantees high-precision temperature control.

Product benefits*

- > UV/Vis spectral range of 200 nm to 830 nm for flexible applications
- > Preprogrammed and freely programmable kinetic methods for convenient working
- > Retrospective modification of the time window for regression analysis
- > Temperature-controlled cuvette shaft (adjustment range +20 °C to +42 °C in 0.1 °C increments) for optimal conditions and results
- > Measurement over time up to 59 m 59s

Focusing on very small sample concentrations?

The integrated fluorescence unit of the BioSpectrometer fluorescence for fluorescent dye tagged samples increases the measuring range by a factor of 1,000, for example, to detect DNA. This enables reliable quantification down to a concentration of 1.0 pg/μL. Measurements can be flexibly executed in the UV/Vis or fluorescence range.

Product benefits*

- > UV/Vis spectral range of 200 nm to 830 nm for flexible applications
- > Preprogrammed and freely programmable fluorescence methods for convenient processing
- > Fluorescence intensity across a range of 0.5 nM up to 2,000 nM fluorescein
- > Fluorescence excitation wavelength 470 nm, emission wavelengths 520 nm and 560 nm

* In addition to all features of the BioSpectrometer basic.

The Smaller the Better

One droplet is the limit?

The μ Cuvette G1.0 is in your range: Only 1.5 μ L of a sample is needed. The optical path length of only 1 mm enables a light path that is 10x shorter than the light path of standard cuvettes: Measure high nucleic acid and protein concentrations.

Product benefits

- > Microvolume measuring cell for measuring 1.5–10 μ L sample volumes
- > Concentration determination of nucleic acids and proteins for broad range of applications
- > Measurement of high sample concentrations without prior dilution for reliable results
- > Exclusively available for all series of Eppendorf BioPhotometer and Eppendorf BioSpectrometer

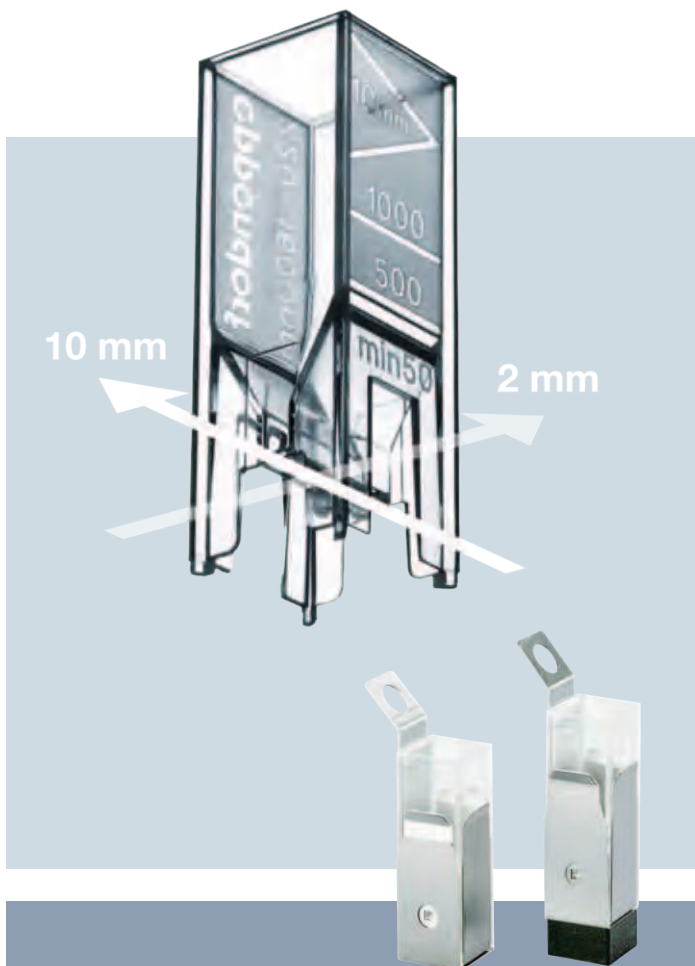

Working with very low amount of samples?

The disposable patented* UVette[®] with two different light paths (10 mm and 2 mm) allows you to conduct flexible measurements. Only one cuvette is needed to measure various concentration ranges with a starting volume of down to 50 μ L. The cuvette is made from UV transparent material.

Product benefits

- > UV/Vis measurements from 220 to 1,600 nm
- > Measurement of absorbance and fluorescence signals for concentration determination
- > Combination of two light paths for flexible usage
- > Single-use, available in certified PCR clean and protein-free quality for sensitive and valuable samples as well as in Eppendorf Quality[®] (bulk)
- > Adapters (single-wrapped) available for use with other common spectrophotometers

* U.S. Patent Nr.: 6,249,345



Measuring Bradford?

The Vis cuvettes are your tool for applications outside of the UV range. This can include colorimetric protein assays (Bradford, Lowry, etc.), determining of the optical density of bacterial cultures, as well as kinetic and fluorescence measurements.

Product benefits

- > Vis measurements from 300 to 900 nm for broad range
- > Suitable for colorimetric protein assays, OD_{600} , and kinetic/ fluorescence measurements for many applications
- > Two different cuvette sizes (semi-micro and macro) for a wide variety of volumes

Light path

Despite different designs, the cuvettes are all suitable for Eppendorf photometers with a light path height of 8.5 mm.

Cuvettes

Basic area 12.5 mm x 12.5 mm

Min. overall height 36 mm

Min. filling level 10 mm

Light path 8.5 mm

Max. height of base 7 mm

0 mm

Min. volume Photometry

Eppendorf
 μ Cuvette G1.0

UVette®

Semi-micro

Macro

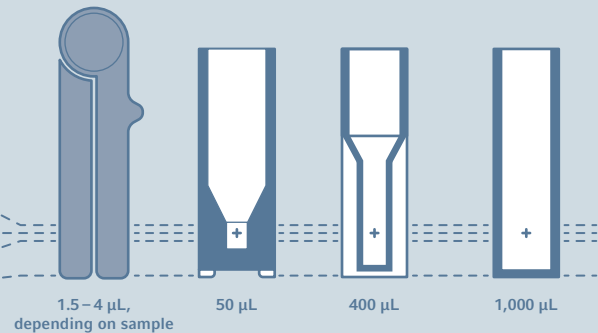

Printed documentation needed?

The Thermal Printer DPU-S445 is a thermal line dot printer with high printing speed while producing a clear type face. This allows the Thermal Printer DPU-S445 to print out graphics as well. The printer is compatible with the BioPhotometer D30 and the BioSpectrometer product line.

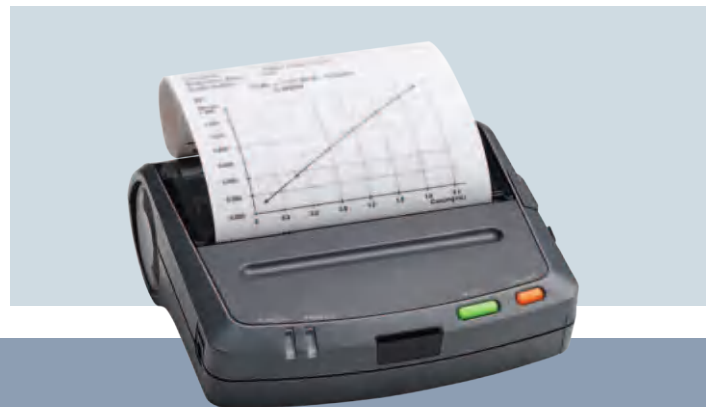

Detection is Part of Our DNA

Based on nearly 70 years of detection experience, Eppendorf has developed a level of expertise through its contributions to the field of photometry. With its current product portfolio, Eppendorf allows you to select the optimal combination of devices and accessories from a large range of products. From fluorescence-based applications to microvolume measurements: Be flexible.



2000
Eppendorf
UVette®



2007
Eppendorf
BioPhotometer® plus



1968
Eppendorf
Photometer
1101 and 1102



1972
Eppendorf
Digital Photometer
6114/15



1992
Eppendorf
Photometer ECOM
6122



1998
Eppendorf
BioPhotometer®
6131

1950
Eppendorf
Photometer »Medeor«
Spectrophotometer



1955
Eppendorf
Flame Photometer





2011

Eppendorf
BioSpectrometer®
basic



2013

Eppendorf
BioSpectrometer®
fluorescence

2011

Eppendorf
BioSpectrometer®
kinetic



2012

Eppendorf
µCuvette® G1.0



2013

Eppendorf
BioPhotometer®
D30







Struggling with Paper-Based Documentation?





Improve your efficiency when documenting research with eLABJournal

The eLABJournal Electronic Lab Notebook offers an intuitive and flexible solution to document and track research data like BioSpectrometer-based values. Improve efficiency when documenting, organizing, searching, and archiving collected data. With the free eLABJournal add-ons, you can extend the functionality of eLABJournal to a fully integrated Laboratory Information Management System.



Technical Specifications

Technical data of instruments	BioSpectrometer basic	BioSpectrometer kinetic	BioSpectrometer fluorescence	BioPhotometer D30
				
Absorption light source	Xenon flash lamp			
Fluorometer light source	–	–	LED	–
Height of light source	8.5 mm			
Absorption measuring principle	Single-beam absorption spectrophotometer with reference beam			Single-beam absorption photometer with reference beam
Fluorometer measuring principle	–	–	Confocal filter fluorometer with reference beam	–
Absorption beam receiver	CMOS photodiode array			CMOS photodiodes
Fluorometer beam receiver	–	–	Photodiodes	–
Wavelength range absorption	Scan (nm): 200–830 at 1 nm increments			Fixed wavelengths (nm): 230, 260, 280, 320, 340, 405, 490, 562, 595, 600
Fluorometer excitation wavelength	–	–	470 nm, bandwidth: 25 nm	–
Fluorometer emission wavelengths	–	–	520 nm, bandwidth: 15 nm 560 nm, bandwidth: 40 nm	–
Temperature control	–	20 °C to 42 °C at 0.1 °C increments	–	–
Absorption spectral bandwidth	< 4 nm			
Absorption measuring range	0 A–3.0 A (260 nm)			
Fluorometer measuring range	–	–	0.5 nM–2,000 nM fluorescein (emission wavelength 520 nm)	–
dsDNA concentration range	2.5 ng/μL–1,500 ng/μL	2.5 ng/μL–1,500 ng/μL	2.5 ng/μL–1,500 ng/μL (with fluorescence down to 1.0 pg/μL)	2.5 ng/μL–1,500 ng/μL
Interfaces	USB master: for USB stick USB slave: for connecting to a PC Interface for Eppendorf thermal printer			
Dimensions (W × D × H)	295 × 400 × 150 mm			
Weight	5.4 kg	5.5 kg	5.4 kg	5.4 kg
Random error absorption	≤ 0.002 at A = 0 ≤ 0.005 (0.5%) at A = 1			

Cuvette technical data	Eppendorf μCuvette® G1.0	UVette®	Macro Vis cuvettes	Semi-micro Vis cuvettes
				
dsDNA (UV) concentration range	25 ng/μL–1,500 ng/μL	2.5 ng/μL–750 ng/μL	–	–
Colorimetric protein assays	–	✓	✓	✓
OD 600 methods	–	✓	✓	✓
Fluorescence measurements	✓	✓	✓	✓
UV transparency	> 180 nm	> 220 nm	–	–
Light transmission	180 nm–2,000 nm	220 nm–1,600 nm	300 nm–900 nm	
Dimensions (W × D × H)	12.5 mm × 12.5 mm × 48 mm	12.5 mm × 12.5 mm × 36 mm	12.5 mm × 12.5 mm × 45 mm	
Temperature control	–	–	✓	–
Minimum filling volume > in Eppendorf photometers > in devices from other manufacturers	1.5 μL –	50 μL 50 μL	1,000 μL 2,500 μL	400 μL 1,500 μL
Maximum filling volume	10 μL	2,000 μL	4,500 μL	3,000 μL
Optical path length(s)	1 mm	2 mm & 10 mm	10 mm	
Cuvette blank at 260 nm	< 0.05 A	< 0.5 A	–	–
Height of light source	8.5 mm	8.5 mm (adapters available for height adjustments)	Measuring window 0–35 mm	Measuring window 0–23 mm
Use in Eppendorf BioPhotometer	✓	✓	✓	✓
Use in Eppendorf BioSpectrometer	✓	✓	✓	✓
Use in devices from other manufacturers	–	✓ (adapters available)	✓	✓

Gain Even More Clarity!

Instrument self-test requested?

The Spectrometer automatically tests the function immediately after it has been switched on. The self test interval is adaptable.

Check needed?

The secondary UV/Vis reference filter set is used to verify the photometric and wavelength systematic errors according to NIST® (National Institute of Standards and Technology, Gaithersburg MD, USA).



Product benefits

- > Filter traceable to NIST for data security, incl. a certificate
- > Preprogrammed log for verification in the devices for easy handling
- > Verification of the photometric precision and accuracy
- > Fluorometric precision and linearity, in the BioSpectrometer fluorescence for longterm instrument reliability

Eppendorf Detection Performance Plans



Certification Services*

Installation Qualification (IQ) and Operational Qualification (OQ) certification services ensure your Quality Management requirements are fulfilled, providing you with qualified assurance that your Photometry Instrument is functioning correctly, in accordance with manufacturers' specifications.

Photometer Test

You are also able to verify photometric and wavelength accuracy and the respective precision using the Secondary UV-VIS Filter Set. In case of non-conformity to specifications, the instrument needs to be checked and properly adjusted by a trained service technician.

* Service products may differ in different countries



eppendorf

Performance tested on

Model: _____

Serial no.: _____

Serviced by: _____

Service no.: _____

Next service: _____

Date: _____

epServices

Ordering information

Description	Order no. International	Order no. North America
Eppendorf μCuvette® G1.0 Eppendorf microvolume measuring cell for Eppendorf BioPhotometer® and Eppendorf BioSpectrometer®	6138 000 018	6138000018
Eppendorf BioPhotometer® D30 > 230V/50–60Hz, mains plug for Europe, additional mains/power connections available > 120V/50–60Hz, mains plug for North America	6133 000 001 6133 000 010	– 6133000010
Eppendorf BioSpectrometer® basic > 230V/50–60Hz, mains plug for Europe, additional mains/power connections available > 120V/50–60Hz, mains plug for North America	6135 000 009 6135 000 017	– 6135000017
Eppendorf BioSpectrometer® kinetic > 230V/50–60Hz, mains plug for Europe, additional mains/power connections available > 120V/50–60Hz, mains plug for North America	6136 000 002 6136 000 010	– 6136000010
Eppendorf BioSpectrometer® fluorescence > 230V/50–60Hz, mains plug for Europe, additional mains/power connections available > 120V/50–60Hz, mains plug for North America	6137 000 006 6137 000 014	– 6137000014
Eppendorf μCuvette® G1.0 & Eppendorf BioPhotometer® D30 Eppendorf microvolume measuring cell and BioPhotometer D30 > 230V/50–60Hz, mains plug for Europe > 120V/50–60Hz, mains plug for North America	6133 000 907 6133 000 908	– 6133000908
Eppendorf μCuvette® G1.0 & Eppendorf BioSpectrometer® basic Eppendorf microvolume measuring cell and Eppendorf BioSpectrometer® basic > 230V/50–60Hz, mains plug for Europe > 120V/50–60Hz, mains plug for North America	6135 000 904 6135 000 905	– 6135000923
Eppendorf μCuvette® G1.0 & Eppendorf BioSpectrometer® kinetic Eppendorf microvolume measuring cell and Eppendorf BioSpectrometer® kinetic > 230V/50–60Hz, mains plug for Europe > 120V/50–60Hz, mains plug for North America	6136 000 800 –	– 6136000851
Eppendorf μCuvette® G1.0 & Eppendorf BioSpectrometer® fluorescence Eppendorf microvolume measuring cell and Eppendorf BioSpectrometer® fluorescence > 230V/50–60Hz, mains plug for Europe > 120V/50–60Hz, mains plug for North America	6137 000 901 –	– 6137000015
Eppendorf BioPhotometer® D30 reference filter set Filter set for verifying photometric accuracy and wavelength systematic error (according to NIST®) in the Eppendorf BioPhotometer® D30	6133 928 004	6133928004
Eppendorf BioSpectrometer® basic & kinetic reference filter set Filter set for verifying photometric accuracy and wavelength systematic error (according to NIST) in the Eppendorf BioSpectrometer® basic and Eppendorf BioSpectrometer® kinetic	6135 928 001	6135928001
Eppendorf BioSpectrometer® fluorescence reference filter set Filter set for verifying photometric accuracy and wavelength systematic error (according to NIST), fluorimetric precision (random error) and linearity	6137 928 009	6137928009
UVette® 220 nm–1,600 nm Plastic cuvette for measurements in the UV and Vis range, individually packaged, certified PCR clean and protein-free, box of 80	0030 106 300	952010051
UVette® routine pack 220 nm–1,600 nm Plastic cuvette for measurements in the UV and Vis range, Eppendorf Quality, reclosable box, box of 200	0030 106 318	952010069
UVette® Starter Set , 80 UVettes and 1 universal adapter for light path height of 15 mm and 8.5 mm, 50–2,000 μ L	4099 100 007	952010077
Macro Vis Cuvettes 300 nm–900 nm Plastic cuvette for measurements in the Vis range, max. filling volume 4,500 μ L, 10 \times box of 100	0030 079 345	0030079345
Semi-micro Vis Cuvettes 300 nm–900 nm Plastic cuvette for measurements in the Vis range, max. filling volume 3,000 μ L, 10 \times box of 100	0030 079 353	0030079353
Adapter for UVette (8.5 mm)	4099 001 009	952010107
Adapter for UVette (10 mm)	4099 002 005	952010123
Adapter for UVette (15 mm)	4099 003 001	9520101115
Adapter for UVette (20 mm)	4099 005 004	4099005004
Adapter for UVette (GeneQuant I/II)	4099 004 008	952010131
Cuvette stand , for 30 cuvettes	0030 119 851	0030119851
Thermal printer DPU-S445	6135 011 000	6135010004
Thermal paper , 5 rolls	0013 021 566	952010409

Eppendorf Photometers: Trust your Results

Discover how the University of East of London keeps their position as one of the most modern universities of the UK: UEL provides education and training for the students while transforming science for tomorrow. Be inspired by the people of UEL and their needs during their daily work.

