

Ion GeneStudio S5 Instrument

USER GUIDE

for use with:

Ion GeneStudio S5 Instrument

Ion GeneStudio S5 Plus Instrument

Ion GeneStudio S5 Prime Instrument

Catalog Numbers A38194, A38195, A38196

Publication Number MAN0017528

Revision A.0



Manufacturer: Life Technologies Holdings Pte Ltd | Block 33 | Marsiling Industrial Estate Road 3 | #07-06, Singapore 739256

The information in this guide is subject to change without notice.

DISCLAIMER: TO THE EXTENT ALLOWED BY LAW, LIFE TECHNOLOGIES AND/OR ITS AFFILIATE(S) WILL NOT BE LIABLE FOR SPECIAL, INCIDENTAL, INDIRECT, PUNITIVE, MULTIPLE, OR CONSEQUENTIAL DAMAGES IN CONNECTION WITH OR ARISING FROM THIS DOCUMENT, INCLUDING YOUR USE OF IT.

Revision history: Pub. No. MAN0017528

Revision	Date	Description
A.0	5 January 2018	New instrument user guide that includes instructions for Ion GeneStudio S5 Series instrument operation and maintenance.

Important Licensing Information: These products may be covered by one or more Limited Use Label Licenses. By use of these products, you accept the terms and conditions of all applicable Limited Use Label Licenses.

Trademarks: All trademarks are the property of Thermo Fisher Scientific and its subsidiaries unless otherwise specified. MAXYMum Recovery is a trademark of Axygen, Inc. Tygon is a trademark of Saint-Gobain Performance Plastics Corp.

©2018 Thermo Fisher Scientific Inc. All rights reserved.

Contents

About this guide	6
Purpose of the guide	6
■ CHAPTER 1 Product information	7
Contents	7
Required materials and equipment not supplied	8
Instrument installation by trained personnel only	9
Nucleic acid contamination	9
Instrument vibration and clearances	9
■ CHAPTER 2 System components	10
Ion GeneStudio S5 System component configuration and layout	10
Internet connectivity	11
Ion GeneStudio S5 System component positions	12
Ion GeneStudio S5 Sequencer input and output connections	13
■ CHAPTER 3 Instrument operation	14
Power the Ion GeneStudio S5 Sequencer on or off	14
Power on	14
Power off	14
Update the Ion GeneStudio S5 System software	14
Ion GeneStudio S5 instrument run times	15
Maintain the sequencer	16
Required materials	16
Clean or decontaminate the sequencer	16
Perform the sequencer cleaning manually	16
Perform an instrument reset run with an initialized, unused Sequencing Reagents cartridge	18

- **APPENDIX A Touchscreen reference** 19
 - Clean, Initialize, and Run 19
 - Settings 20
 - Network Settings 20
 - System Tools 23
 - Check for software updates 28
 - Data Management 29
 - Manually delete run data 31
 - Perform the instrument Clean operation 32
 - Instrument Settings 33
 - Touchscreen icons 37
 - Alarms, Notifications, and Events 39
- **APPENDIX B Troubleshooting** 42
 - Sequencer alarms and events 42
 - Initialization fails 43
 - Troubleshooting using control libraries 45
 - Troubleshooting using Control Ion Sphere™ Particles 45
 - Solid-state buffer leak 46
 - Pulse clean the sequencer 46
- **APPENDIX C Supplemental procedures** 48
 - Set up and test the Ion Chip™ Minifuge 48
 - Install the Ion S5™ /Ion Proton™ Rotor and Buckets 48
 - Test the minifuge 50
- **APPENDIX D Instrument warranty** 52
- **APPENDIX E Safety** 54
 - Safety alerts on this instrument 54
 - Location of safety labels on this instrument 55
 - Safety information for instruments not manufactured by Thermo Fisher Scientific 55
 - Instrument safety 56
 - General 56
 - Cleaning and decontamination 56
 - Electrical 57
 - Safety and electromagnetic compatibility (EMC) standards 58
 - Safety 58
 - EMC 58
 - Environmental design 59
 - Chemical safety 60

Documentation and support	62
Related documentation	62
Customer and technical support	62

About this guide



CAUTION! ABBREVIATED SAFETY ALERTS. Hazard symbols and hazard types specified in procedures may be abbreviated in this document. For the complete safety information, see the “Safety” appendix in this document.

IMPORTANT! Before using this product, read and understand the information in the “Safety” appendix in this document.

Purpose of the guide

The *Ion GeneStudio S5 Instrument User Guide* (Pub. No. MAN0017528) provides reference information for using and maintaining the Ion GeneStudio S5 (Cat. No. A38194), Ion GeneStudio S5 Plus (Cat. No. A38195), and Ion GeneStudio S5 Prime (Cat. No. A38196) Sequencers.

Note: In this user guide, Ion GeneStudio S5 Sequencer or System refers generically to the three Ion GeneStudio S5 Sequencers or Systems, unless otherwise specified.

The Ion S5™ Sequencer and the Ion S5™ XL Sequencer are no longer available for purchase and are replaced by the Ion GeneStudio S5 Sequencer and Ion GeneStudio S5 Prime Sequencer, respectively. Both of the Ion S5™ and Ion S5™ XL Sequencers continue to be supported by Thermo Fisher Scientific. See the *Ion S5™ and Ion S5™ XL Instrument User Guide* (Pub. No. MAN0010811) for reference information for the Ion S5™ and Ion S5™ XL Sequencers.



Product information

Contents

The Ion GeneStudio S5 (Cat. No. A38194), Ion GeneStudio S5 Plus (Cat. No. A38195), and Ion GeneStudio S5 Prime (Cat. No. A38196) Systems contain the following boxes and components.

Ion GeneStudio S5 System (Cat. No. A38194)

Components	Part No.
Ion GeneStudio S5 Sequencer	A37904
Ion S5™ Installation Kit	A27215

Ion GeneStudio S5 Plus System (Cat. No. A38195)

Components	Part No.
Ion GeneStudio S5 Plus Sequencer	A37259
Ion S5™ Installation Kit	A27215

Ion GeneStudio S5 Prime System (Cat. No. A38196)

Components	Part No.
Ion GeneStudio S5 Prime Sequencer	A37260
Ion Torrent™ Server	A36305
Ion S5™ Installation Kit	A27215

Ion S5™ Installation Kit (Part No. A27215; Not available for separate purchase.)

Contents	Part No.	Quantity	Storage
Ion 540™ Chip Kit	A27765	4 pack	15°C to 30°C
Ion S5™ Sequencing Solutions	A27767	1	
Ion S5™ Sequencing Reagents	A27768	1	
Ion 540™ Control Ion Spheres	A28195	1	-30°C to -10°C
Ion 540™ Loading Reagents OT2	A27897	1	
Ion S5™ Cartridge Tool	A28308	2	
Ion S5™ Chip Balance Pack	A29022	1	15°C to 30°C

Required materials and equipment not supplied

Unless otherwise indicated, all materials are available through **thermofisher.com**.
MLS: Fisher Scientific (**fisherscientific.com**) or other major laboratory supplier.

✓	Item ^[1]	Source
	Ion Chip™ Minifuge (120 V or 230 V; required for use only with the Ion OneTouch™ 2 System.)	4479672 (120V) <i>or</i> 4479673 (230V)
	Ion S5™/Ion Proton™ Rotor and Buckets Kit (required for use only with the Ion OneTouch™ 2 System.)	4482578
	{ <i>Optional</i> } Non-interruptible Power Supply (UPS) ^[2]	MLS
	Thermal cycler with a heated lid	MLS
	Microcentrifuge ^[3]	MLS
	1.5-mL or 1.7-mL microcentrifuge tubes	MLS
	0.2-mL MAXYMum Recovery™ Thin Wall PCR Tubes, Flat Cap (do not use polystyrene tubes)	Axygen, PCR-02-L-C
	Pipettes (P2, P10, P20, P200, P1000) and appropriate low-retention filtered tips	MLS
	Isopropanol (100%)	MLS
	Nuclease-free water molecular biology grade	MLS
	Standard laboratory vacuum line or vacuum pump	MLS
	Liquid trap	MLS
	Tygon™ tubing ^[4]	MLS
	Vortex mixer	MLS

^[1] IMPORTANT! Thermo Fisher Scientific has verified the procedures in this user guide using these specific materials. Substitution may adversely affect system performance.

^[2] For laboratories that experience frequent power outages or line voltage fluctuations, we recommend that you use a non-interruptible power supply that is compatible with 2500 W output or higher.

^[3] Must fit standard 1.5- and 0.2-mL microcentrifuge tubes and generate 15,500 × *g*.

^[4] As needed to connect laboratory vacuum to liquid trap and liquid trap to P200 pipette tip.

Instrument installation by trained personnel only

IMPORTANT! The Ion GeneStudio S5 System is installed by trained service personnel and must not be relocated without assistance from trained service personnel. See “Customer and technical support” on page 62.

Nucleic acid contamination

IMPORTANT! A primary source of contamination is DNA fragments from previously processed samples. Do not introduce amplified DNA into the library preparation laboratory or work area.

Instrument vibration and clearances

IMPORTANT! Significant vibration during sequencing may add noise and reduce the quality of the measurements. The Ion GeneStudio S5 System must be installed on a bench that is free from vibrations or in contact with equipment that can cause vibrations to the bench (freezers, pumps, and other similar equipment).

IMPORTANT! Place the instrument at least 40 in. (1 meter) away from major sources of electronic noise such as refrigerators or microwaves.

Ion GeneStudio S5 System component configuration and layout

The Ion GeneStudio S5 Sequencer uses a virtual server, and the Ion GeneStudio S5 Plus Sequencer is equipped with an internal Torrent Server. These instruments are not connected to an external Torrent Server. The Ion GeneStudio S5 Prime System includes the Ion GeneStudio S5 Prime Sequencer and an external Torrent Server.

We support the layout in which the external Torrent Server is connected directly to the Ion GeneStudio S5 Prime Sequencer, instead of through a local area network from a remote location such as a server room. Data are most robustly transferred from the Ion GeneStudio S5 Prime Sequencer to the Torrent Server when they are connected directly by a standard Category 6 Ethernet cable that is provided with the installation materials.

IMPORTANT! The Ion GeneStudio S5 Prime Sequencer must be connected to the Torrent Server by a standard Category 6 Ethernet cable. We do not troubleshoot data transfer problems that are associated with an indirect connection between the Ion GeneStudio S5 Prime Sequencer and the Torrent Server.

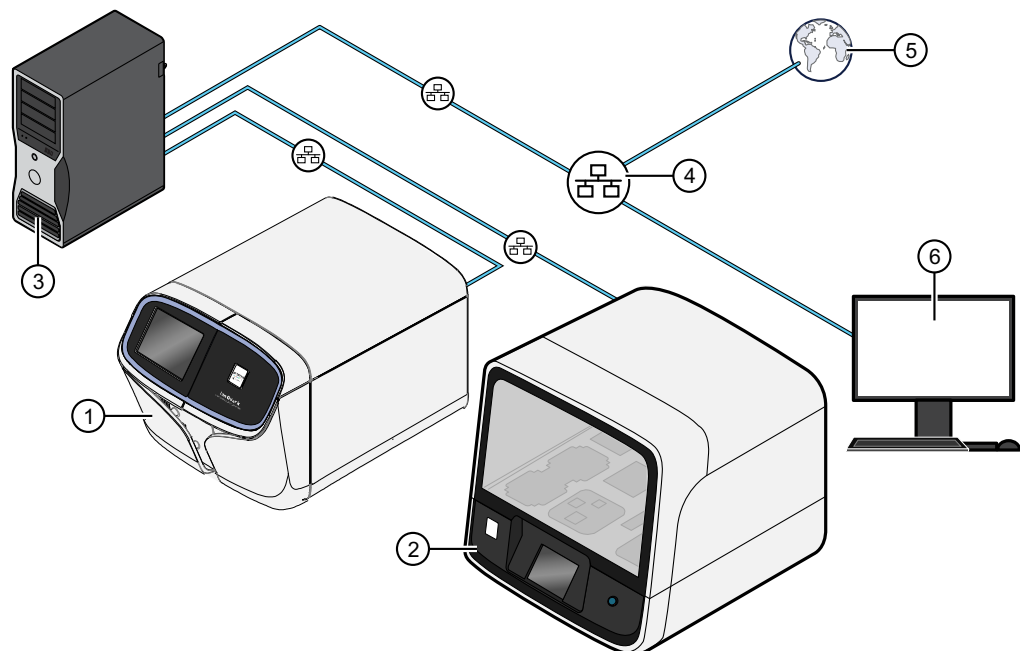

Ion GeneStudio S5 Prime System configuration

- | | |
|--|----------------------|
| ① Ion GeneStudio S5 Prime Sequencer | ③ Torrent Server |
| ② Ion template preparation instrument
(Ion Chef™ Instrument (shown) or
Ion OneTouch™ 2 System) | ④ Local area network |
| | ⑤ Internet |
| | ⑥ Client computer |

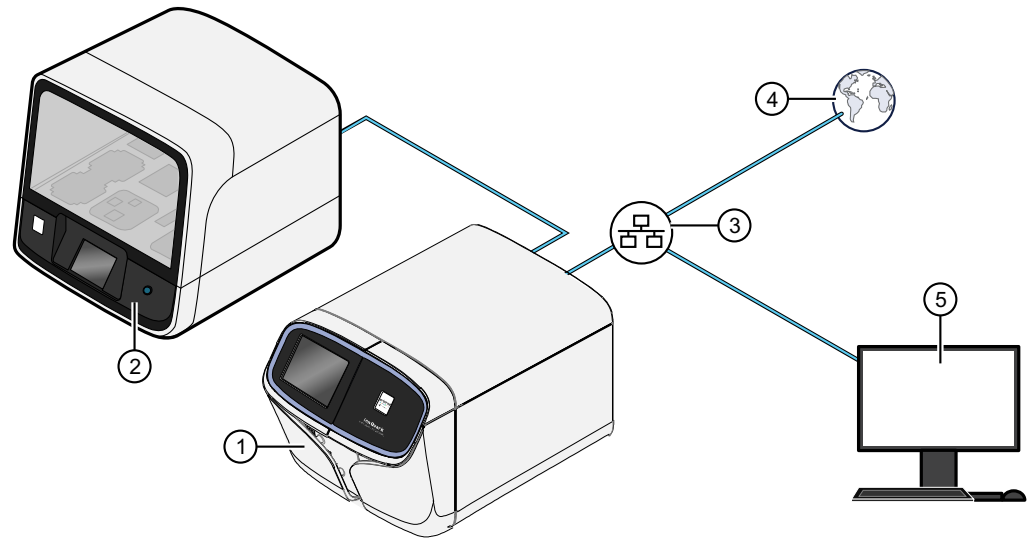

Ion GeneStudio S5 System, or Ion GeneStudio S5 Plus System configuration

- ① Ion GeneStudio S5 Sequencer, or Ion GeneStudio S5 Plus Sequencer
- ② Ion template preparation instrument (Ion Chef™ Instrument (shown) or Ion OneTouch™ 2 System)
- ③ Local area network
- ④ Internet
- ⑤ Client computer

Internet connectivity

The Ion GeneStudio S5 Sequencer, the Ion GeneStudio S5 Plus Sequencer, or the Torrent Server (in an Ion GeneStudio S5 Prime System) should be connected to a network with internet access. Connecting to the Internet allows you to update your software and access remote system support easily. Software updates through the network/internet are free. If you do not connect your instrument or server to a network, software updates must be manually installed via USB.

IMPORTANT! Thermo Fisher Scientific does not support the USB method for updating software.

Any problems (for example, file corruption, incomplete updates) resulting from update of the sequencer or server using a USB device that require correction of the faulty update is not covered by your Ion GeneStudio S5, Ion GeneStudio S5 Plus, or Ion GeneStudio S5 Prime Sequencer warranty or any service contract you may have bought. You are required to schedule an on-site Time and Materials visit by a field service engineer to correct the problem at your own expense.

In providing outbound access to the Internet from the server, you enable the support team to provide inbound support. The Ion GeneStudio S5 Sequencer, the Ion GeneStudio S5 Plus Sequencer, and the Torrent Server run a remote monitor agent that can provide service personnel with critical system information, such as installed software versions and instrument alarms. With your permission, the agent also allows service personnel to access remotely the Ion GeneStudio S5 Sequencer, the Ion GeneStudio S5 Plus Sequencer, or the Torrent Server, which is required for system

support. Without remote access, service personnel cannot access, view, and troubleshoot problems regarding machine performance.

To enable full support, the Torrent Server must have outbound internet access (ports 22, 80, and 443) and be behind an appropriately configured firewall. Although not recommended, you can enable access to the Torrent Browser (the web server running on the Torrent Server from the Internet). If you provide such access, you must restrict access to the server using HTTP and AUTH firewall rules, or a combination of the two. Implementing and maintaining such restrictions is the responsibility of your server administrator and not of Thermo Fisher Scientific.

Note: For further support and troubleshooting for Torrent Server network access requirements, see Software Administration in *Torrent Suite™ Software Help*.

Ion GeneStudio S5 System component positions



- ① Touchscreen
- ② Power button
- ③ Ion S5™ Sequencing Reagents cartridge
- ④ Chip clamp
- ⑤ Ion S5™ Wash Solution bottle. Waste reservoir located behind the Wash Solution bottle (shown on the right).
- ⑥ Ion S5™ Cleaning Solution bottle
- ⑦ Waste reservoir

Note: The system uses RFID technology to verify that the proper reagents are loaded in positions 3, 5, and 6. Reagents that exceed their expiration date or usage count generate an error message prompting the user to replace the reagent before performing the run.

Note: RFID regulatory information can be found on the main screen under **Options ▶ Regulatory info**.

Ion GeneStudio S5 Sequencer input and output connections

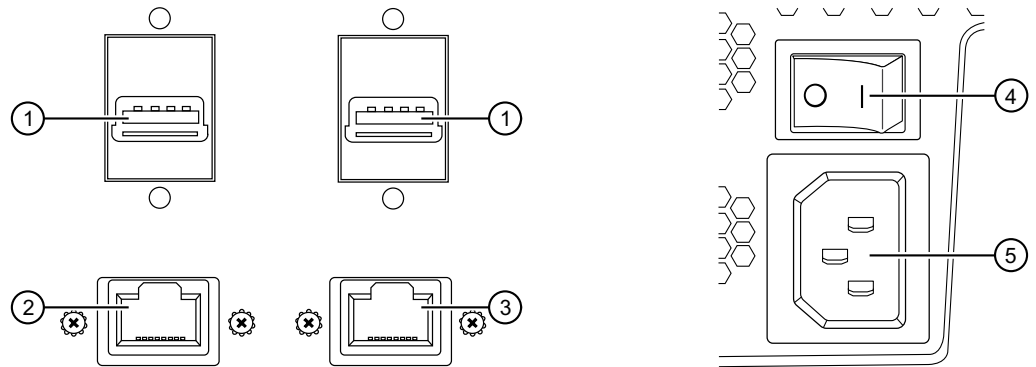

- ① USB ports – Connects a USB device to the instrument.
- ② Ethernet port – An RJ45 port that provides Ethernet (Gigabit) communication between the sequencer and a local area network.
- ③ Ethernet port – An RJ45 port that provides Ethernet (Gigabit) communication with the Ion Chef™ Instrument.
- ④ On/off switch – Power switch, where the states are on (I) or off (O).
- ⑤ Power port – 100-240VAC port that provides power to the instrument.

Power the Ion GeneStudio S5 Sequencer on or off

Note: If the Ion GeneStudio S5 Sequencer is powered on, and the touchscreen is blank, touch the screen to "wake" the touchscreen.

Power on

If the touchscreen is unresponsive, check the power switch on the back of the instrument to ensure that the switch is in the on (I) position. If the power switch is in the off (O) position, proceed with step 1. If the power switch is already in the on position, proceed to step 2.

1. Turn the power switch on the back of the instrument to the on (I) position.
2. Press the power button on the left side of the instrument.
The button illuminates. When the instrument touchscreen Main Menu appears, the instrument is ready for use.

Power off

It is not necessary to power off the instrument overnight or over the weekend. If the instrument will not be used for more than 3 days, power off the instrument as follows:

1. In the Main Menu, press **Settings** ▶ **System Tools** ▶ **Shut Down**.
2. Select either **Shut Down** or **Reboot**.

Note: If you select **Shut Down**, a confirmation message appears. Select **Yes** to power off the instrument.

Note: Do *not* press the power button during a run. Interrupting power to the instrument during a run may result in sequencing run failure and loss of sample.

Update the Ion GeneStudio S5 System software

Note: An internet connection is required for the Ion GeneStudio S5 System to receive alerts that software updates are available.

If an update to the Ion GeneStudio S5 Sequencer software is available, the **Notifications/Alarms** button illuminates red in the touchscreen Main Menu. Press the red **Alarms** button to see the detailed messages. If a message states New Software Available, follow these steps to update the software:

1. In the Main Menu, press **Settings** ▶ **Check for Updates**.
2. Press **Update** to download and install the updates automatically.
3. Press **Done**.

The instrument automatically restarts when the software update is complete.

Ion GeneStudio S5 instrument run times

Approximate Ion GeneStudio S5 instrument run times for a given chip type, read length, and number of reads are shown in the following table. Run times indicate typical time from run start to BAM file delivery (1 run/initialization).

Chip type	Number of reads	Read length/output	Instrument run time		
			Ion GeneStudio S5 Sequencer	Ion GeneStudio S5 Plus Sequencer	Ion GeneStudio S5 Prime Sequencer
Ion 510™ Chip	2–3 M	200 bases 0.3–0.5 Gb	4.5 hours	3 hours	3 hours
		400 bases 0.6–1 Gb	10.5 hours	5 hours	5 hours
Ion 520™ Chip	4–6 M	200 bases 0.6–1 Gb	7.5 hours	3.5 hours	3 hours
		400 bases 1.2–2 Gb	12 hours	5.5 hours	5.5 hours
	3–4 M	600 bases 0.5–1.5 Gb	12 hours	5.5 hours	5.5 hours
Ion 530™ Chip	15–20 M	200 bases 3–4 Gb	10.5 hours	5 hours	4 hours
		400 bases 6–8 Gb	21.5 hours	8 hours	6.5 hours
	9–12 M	600 bases 1.5–4.5 Gb	21 hours	8 hours	7 hours
Ion 540™ Chip	60–80 M	200 bases 10–15 Gb	19 hours	10 hours	6.5 hours
Ion 550™ Chip	100–130 M	200 bases 20–25 Gb	—	11.5 hours	8.5 hours

Maintain the sequencer

Required materials

- Lint-free wipes
- 70% isopropanol
- (Optional) 10% bleach solution

Clean or decontaminate the sequencer

In the event of a spill or leak on or inside the instrument, perform the following steps.

Note: Dispose of all waste in appropriate liquid or solid waste containers.

1. Remove the Ion S5™ Wash Solution bottle, then remove and empty the waste reservoir.
2. Remove the Ion S5™ Sequencing Reagents cartridge.
3. Inspect the waste and nucleotide reagent bays for liquid.
4. Using absorbent paper soak up as much liquid as possible, then wash the affected area with 10% bleach solution.
5. Wipe the affected surfaces with 70% isopropanol, then allow to air-dry.

Perform the sequencer cleaning manually

The Ion GeneStudio S5 Sequencers require cleaning before initialization. Cleaning is normally performed automatically at the completion of the previous sequencing run. To enable two sequencing runs on a single initialization, you must deselect the "Enable post-run clean" checkbox for the first sequencing run. The post-run cleaning is then performed normally after the second sequencing run. However, if the "Enable post-run clean" checkbox is deselected for the second run, the cleaning is not performed after either run. If the second sequencing run is not performed, or the cleaning is not performed automatically after the second run, the instrument will not allow the subsequent initialization to proceed until a manual cleaning has been performed.

If an Ion GeneStudio S5 Sequencer is initialized and

- a sequencing run is not started within 24 hours, *or*
- a run is not started or completed due to a power failure or an abort

do not perform a manual cleaning. An instrument reset run is required before reinitialization. See "Perform an instrument reset run with an initialized, unused Sequencing Reagents cartridge" on page 18 for more information.

When a cleaning is necessary, use the following procedure:

1. On the home screen, press **Settings** ▶ **Clean Instrument**.
The instrument door unlocks allowing access to the consumables.
2. Remove the Ion S5™ Wash Solution bottle to access the waste reservoir, then remove and empty the waste reservoir.

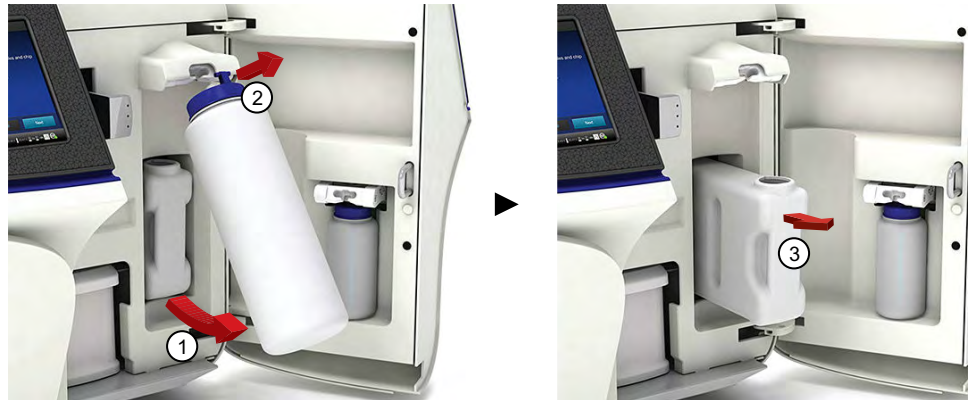

3. Reinstall the empty waste reservoir and a *used* Ion S5™ Wash Solution bottle.
4. Ensure the Ion S5™ Sequencing Reagents cartridge and Ion S5™ Wash Solution bottle are properly installed.

IMPORTANT! Perform the cleaning with a used reagent cartridge and wash solution bottle installed. The cleaning procedure pumps cleaning solution into the wash solution bottle and reagent cartridge making them unsuitable for sequencing.

5. Place a used sequencing chip in the chip clamp, then push the chip clamp in all the way to engage.
6. Close the instrument door, then press **Next**.
Cleaning takes ~35 minutes to complete. On completion, the instrument door automatically unlocks and the chip and cartridge clamps disengage.

Perform an instrument reset run with an initialized, unused Sequencing Reagents cartridge

Cleaning is normally performed at completion of a sequencing run automatically. If an Ion GeneStudio S5 is initialized and

- a sequencing run is not started within 24 hours after initialization, *or*
- a sequencing run is not completed due to a power failure or an abort, and <200 flows occurred before the stoppage

an instrument reset run is required to ensure proper cleaning before reinitialization. Do NOT perform a manual cleaning with an unused, initialized Ion S5™ Sequencing Reagents cartridge.

Note:

- If a power failure or abort occurs during the second of two runs started after a single initialization, a manual cleaning (page 16) is sufficient.
- If the number of flows that occurred before a power failure or abort is unknown, perform an instrument reset run.

To perform an instrument reset run, use the following procedure before reinitialization:

1. In the instrument touchscreen main menu, press **Run**.
The instrument door unlocks and the chip clamp disengages.
2. Ensure that a used sequencing chip is in the chip clamp, then push the chip clamp in all the way to engage.
3. Close the instrument door, then press **Next**.
4. When prompted, select **Planned Run (none)**. Ensure that the **Enable post-run clean** checkbox is selected, then press **Review**.
5. In the **Select Run** screen, press **Edit**, then in the **Detail** screen set the number of flows to **200**. Ensure that the **Post-Run/Clean** checkbox is selected, then press **Close**.
6. Press **Start run**, then press **Accept** to confirm that Post-Run Clean is enabled, and to start the run.

When the instrument reset run completes, the instrument automatically performs the cleaning procedure. After cleaning, the touchscreen returns to the main menu.



Touchscreen reference

Clean, Initialize, and Run



In the **Home** screen, the **Clean**, **Initialize**, and **Run** programs lead you through the necessary steps to prepare the instrument for sequencing and to start a sequencing run. Press the main dial to start a program. Simple, easy to follow instructions are provided on the touchscreen.

- Cleaning must be performed before each initialization to ensure that the reagents from the previous run are cleared from the fluid lines. The **Clean** program is normally performed automatically at the completion of the previous sequencing run. Perform a **Clean** if for any reason the sequencing run was not properly completed. Follow the instructions that are provided on the touchscreen.
- The **Initialize** program must be performed before each run to load and prepare the run reagents. The **Initialize** program walks you through:
 - Emptying the waste reservoir
 - Loading the reagent cartridge, wash solution, and cleaning solution
- The **Run** program walks you through steps leading up to and through sequencing, including:
 - Placing a loaded chip on the instrument
 - Selecting a Planned Run created in the Torrent Suite™ Software
 - Performing sequencing

Settings

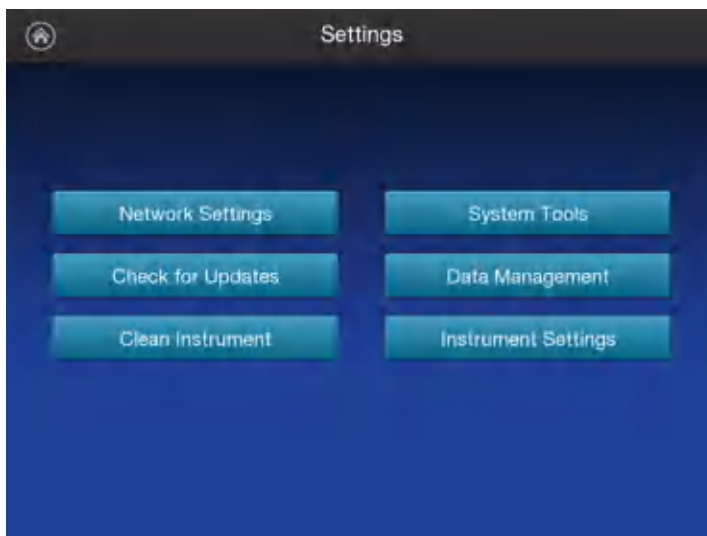

In the **Settings** menu, users can view and/or change instrument settings, manage data and network configurations, and update the installed software.

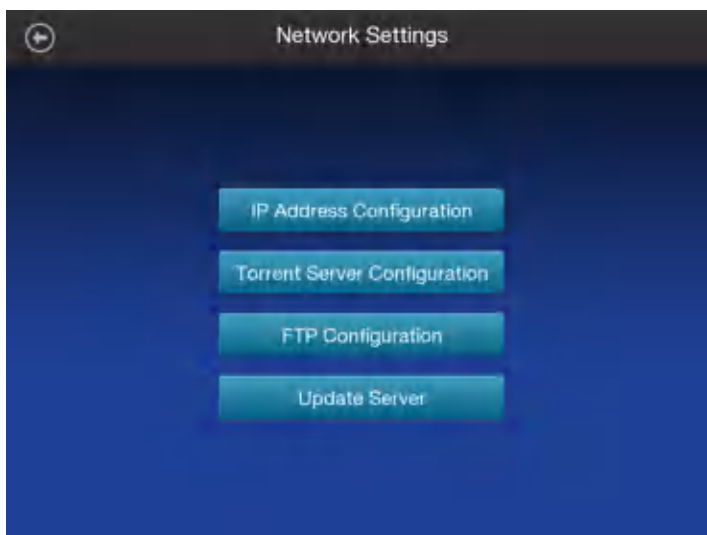

Network Settings

The **Network Settings** menu allows you to configure IP address, Torrent Server, and FTP settings.



Item	Description	When/How to use
<p>IP Address Configuration</p>	<p>Allows users to set or change the IP configuration (DHCP or Static IP).</p> 	<ol style="list-style-type: none"> 1. Select either the DHCP or Static IP radio button. 2. Touch the screen in the field you want to edit to activate the field. A virtual keyboard appears. 3. Enter the new information, then press Done.
<p>Torrent Server Configuration</p>	<p>Allows users to change the Torrent Server IP address and user information.</p>  <p>Enter one of the following IP addresses in the TSUrl field for your instrument:</p> <ul style="list-style-type: none"> • Ion GeneStudio S5/Ion GeneStudio S5 Plus Sequencer: 192.168.122.249 • Ion GeneStudio S5 Prime Sequencer: 192.168.201.1 	<p>When a change to the Torrent Server IP address or user information is required.</p>

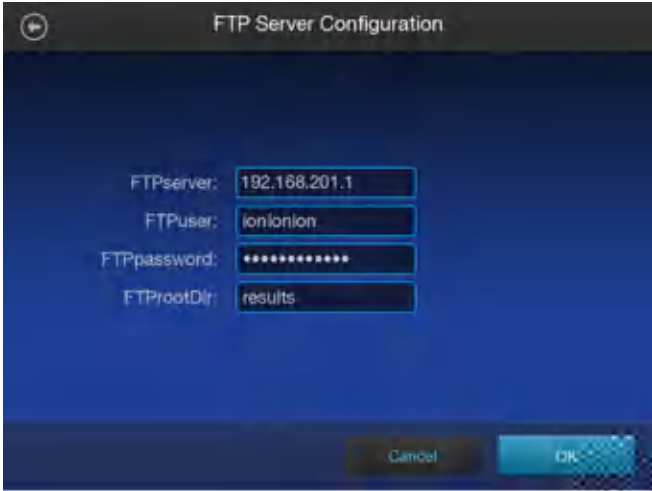
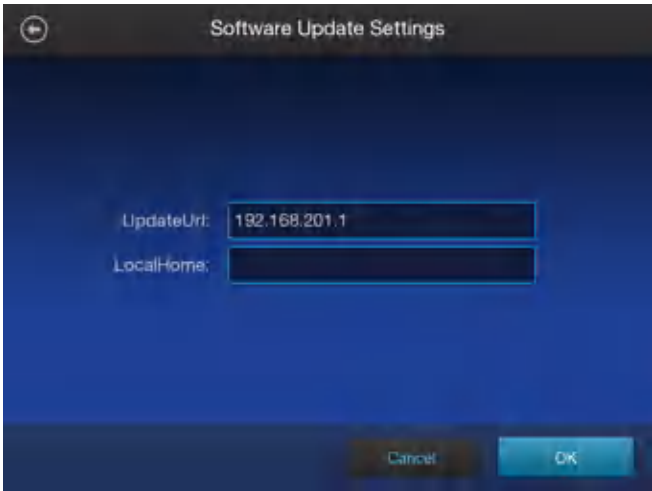

Item	Description	When/How to use
<p>FTP Server Configuration</p>	<p>Allows users to change the FTP Server IP address and user information.</p>  <p>Enter the following IP address in the FTPserver field for your instrument:</p> <ul style="list-style-type: none"> • Ion GeneStudio S5/Ion GeneStudio S5 Plus Sequencer: 192.168.122.249 • Ion GeneStudio S5 Prime Sequencer: 192.168.201.1 	<p>When a change to the FTP Server IP address or user information is required.</p>
<p>Update Server</p>	<p>Allows users to update the software update server.</p>  <p>Enter the following IP address in the UpdateUrl field for your instrument:</p> <ul style="list-style-type: none"> • Ion GeneStudio S5/Ion GeneStudio S5 Plus Sequencer: 192.168.122.249 • Ion GeneStudio S5 Prime Sequencer: 192.168.201.1 	<p>When a change to the URL for the software update server is required. The values on this screen are set at installation. Do not change the settings except at the direction of Thermo Fisher Scientific service staff.</p>



System Tools

The **System Tools** menu enables you to upload instrument diagnostics, manage data, and shut down or reboot the instrument.



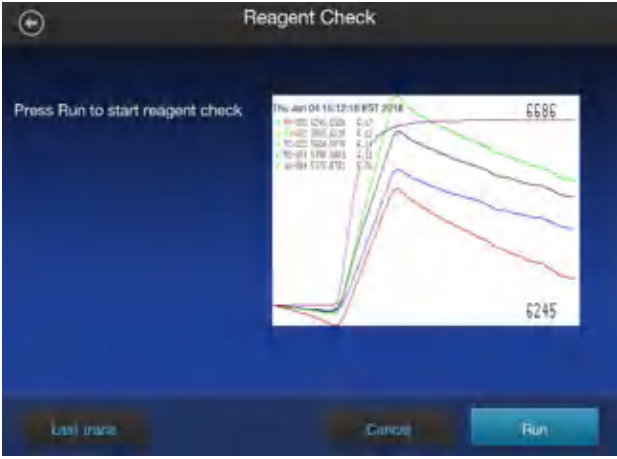

Item	Description	When/How to use
RFID	<p>Lists the product, product expiration date, and remaining uses of the product.</p> 	<p>To determine if reagents that were left on an instrument during a period of instrument shutdown have expired.</p> <ol style="list-style-type: none"> 1. Press the screen within the row of the product to view an RFID Tag Detail page. 2. Press Done to return.

Item	Description	When/How to use
<p>Noise Test</p>	<p>Provides real-time measurement of electrical noise readings on the chip.</p> 	<p>For troubleshooting if directed to do so by Technical Support.</p>
<p>Chip Calibration</p>	<p>Checks the status of a chip.</p> 	<ol style="list-style-type: none"> 1. Insert a chip into the chip clamp. 2. Press Chip Calibration to start the chip calibration. 3. In the dropdown lists, select the Image to display and the type of Calibration to perform. 4. Press Cancel to quit the chip calibration.

Item	Description	When/How to use
<p>Reagent Check</p>	<p>Reagent Check, performed by the instrument as part of initialization, confirms that initialization passes by testing reagent flow and signal detection.</p>   <p>Example Reagent Check for an Ion 540™ Chip</p>  <p>Example Reagent Check for an Ion 550™ Chip</p>	<p>If directed to do so by Technical Support as part of a troubleshooting procedure.</p> <ul style="list-style-type: none"> • Press Run to start the reagent check. • Press Last Trace to review the most recent reagent check result trace. <p>Note: Reagent Check confirms that the chip calibration passes, and will only fail if the chip is defective, or Ion S5™ Wash Solution is not flowing.</p>

Item	Description	When/How to use
<p>Filesystems and disks</p>	<p>Provides real-time drive activity status and disk space used.</p> 	<p>Use if directed to do so as part of a troubleshooting procedure:</p> <ol style="list-style-type: none"> 1. In the System Tools menu, press Disk Drives. The Filesystems screen opens. 2. Press the screen within the row of the Filesystem you want to view, then press Details. The Disk Drives in <Filesystem> screen opens. 3. Press the screen within the row of the Drive to view details of the disk drive. The Details for <Drive> screen opens. 4. Press Done to return to the previous screen.

Item	Description	When/How to use
<p>Pulse clean</p>	<p>Provides step by step instruction to perform a pulse clean of the instrument if a solid-state buffer leak occurs.</p> 	<p>Use if directed to do so by Technical Support as part of a troubleshooting procedure:</p> <ol style="list-style-type: none"> 1. Install consumables and a used sequencing chip. <p>Note: Install Cleaning solution in both the Wash solution (1) and Cleaning solution (2) locations. Use an empty Reagent cartridge.</p> <ol style="list-style-type: none"> 2. Close the instrument door, then press Next. <p>The pulse cleaning procedure starts automatically.</p>
<p>Upload Diagnostics</p>	<p>Allows upload of instrument diagnostics files for review by support personnel.</p> 	<p>For troubleshooting if directed to do so by Technical Support.</p> <p>Note: The system must be connected to an active network port. If no network is present, the file is pushed to the Torrent Browser. You can then download the file and email it to Technical Support.</p> <p>To retrieve the file using the Torrent Browser, navigate to Help ▶ Instrument Diagnostics, then follow the on-screen instructions.</p>

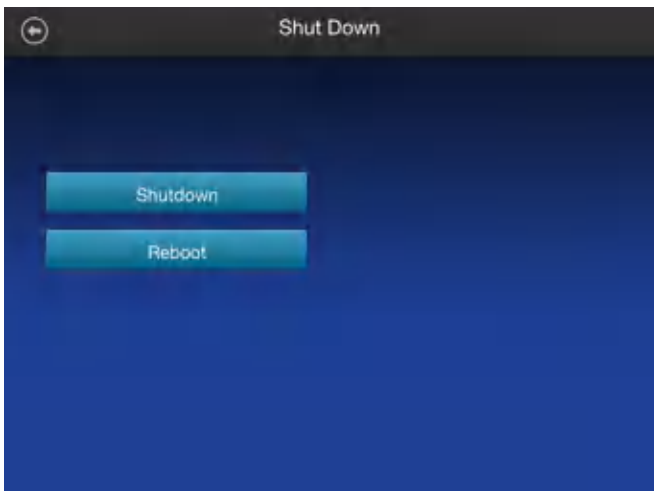
Item	Description	When/How to use
Shut Down	<p>Access to "Shut Down" and "Reboot" commands.</p>  <p>Note: It is not necessary/recommended to shut down the instrument overnight or over the weekend. If needed to shut down the instrument, see "Power the Ion GeneStudio S5 Sequencer on or off" on page 14.</p>	If directed to do so by Technical Support as part of a troubleshooting procedure.

Check for software updates

When software updates are available users will receive a Notification through the home screen.

1. In the **Settings** menu, press **Check for Updates**.
The **Software Update** screen lists the available updates.



2. Press **Update** to automatically download and install the updates.

Data Management The **Data Management** function allows users to manually delete run data, analyze the data, or transfer the data to the Torrent Server. Under normal conditions, run data is automatically transferred to the server, then deleted from the instrument hard drive.

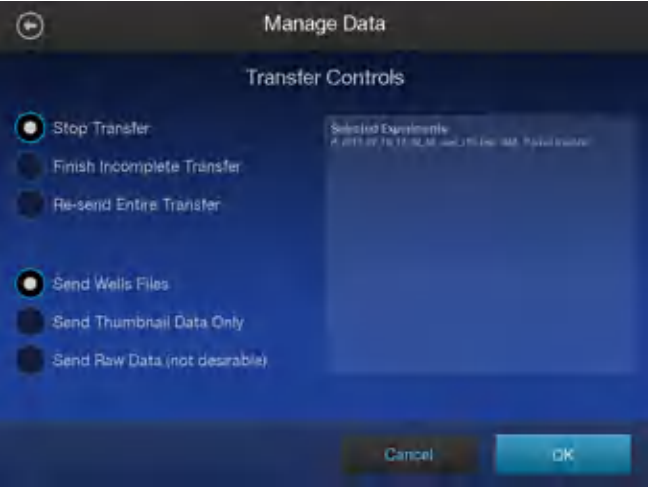
Item	Description	When/How to use
Delete data	Manually delete run data from the instrument.	If the instrument hard drive becomes full, see “Manually delete run data” on page 31.
Transfer data		<p>Transfer run data from the instrument hard drive to the Torrent Server.</p> <ol style="list-style-type: none"> 1. Touch the screen in the Experiment Name row of the individual experiment to be transferred. 2. Press Transfer. 3. Select the radio button of the action to be performed. 4. Select the radio button of the files to be transferred. 5. Press OK.

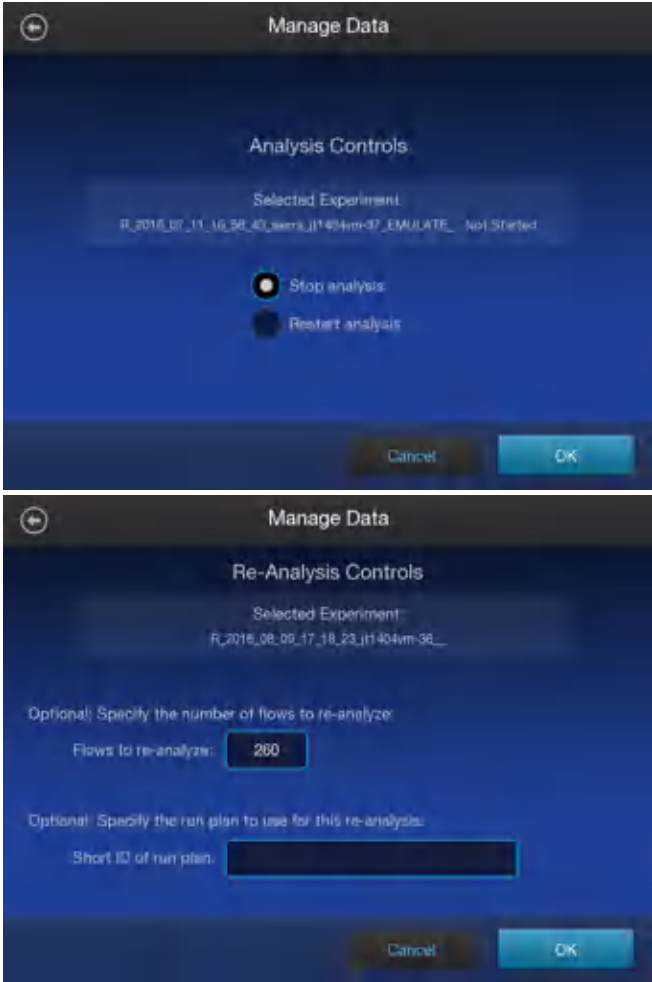
Item	Description	When/How to use
Analysis Controls	<p>Allows the user to stop or reanalyze the data of individual runs.</p> 	<ol style="list-style-type: none"> 1. Touch the screen in the Experiment Name row of the individual experiment to be analyzed, then press Analysis. 2. Select the Stop Analysis or Restart Analysis radio button, then press OK. 3. If performing a re-analysis, follow the on-screen instructions, then press OK.

Manually delete run data

To troubleshoot data management issues the **Data Management** function allows users to manually delete run data or transfer the data to the server. Under normal conditions, run data is automatically transferred to the Torrent Server, then deleted from the instrument hard drive.

1. In the **Settings** menu, press **Data Management** to access the Data Management screen, then press **Manage**.

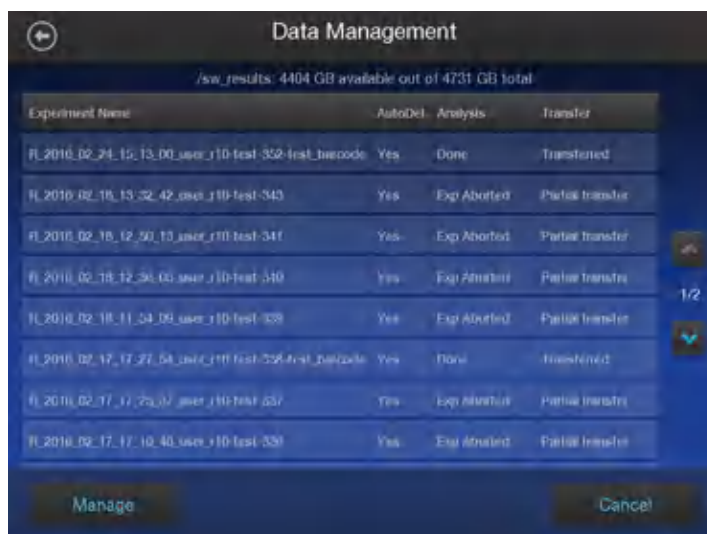

2. Press **Select All** to select all the available experiments, or touch the screen in the **Experiment Name** row of the individual experiment to be managed.

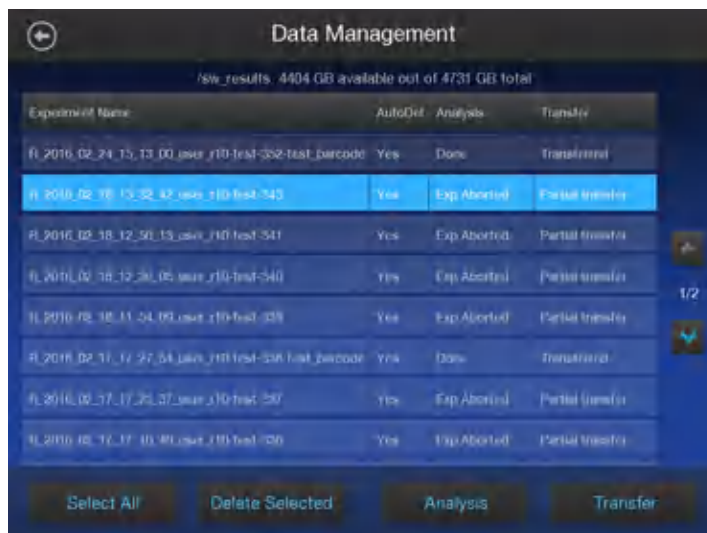

3. Press **Delete Selected**.

Perform the instrument Clean operation

The **Clean** program is normally performed automatically at the completion of the previous sequencing run. Perform a **Clean** if the sequencing run:

- was aborted or had a power failure during the second of two runs started after a single initialization.
- is not completed and >200 flows occurred before the stoppage.
- the post-sequencing run cleaning was not completed.

IMPORTANT! Do NOT perform a manual cleaning with an unused, initialized Ion S5™ Sequencing Reagents cartridge. Perform an instrument reset run instead. See “Perform an instrument reset run with an initialized, unused Sequencing Reagents cartridge” on page 18 for more information.

1. In the **Settings** menu, press **Clean Instrument**.
The Clean procedure begins automatically.
2. Follow the on-screen instructions (see page 16 for more information), then press **Next**.



The user interface returns to the Home screen when the cleaning is complete.



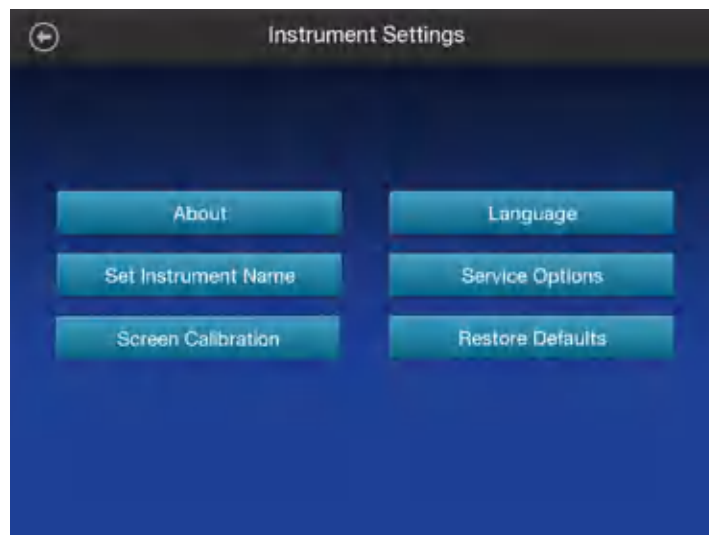

Instrument Settings

The **Instrument Settings** menu provides information about the instrument and allows the user to set the instrument name and language.

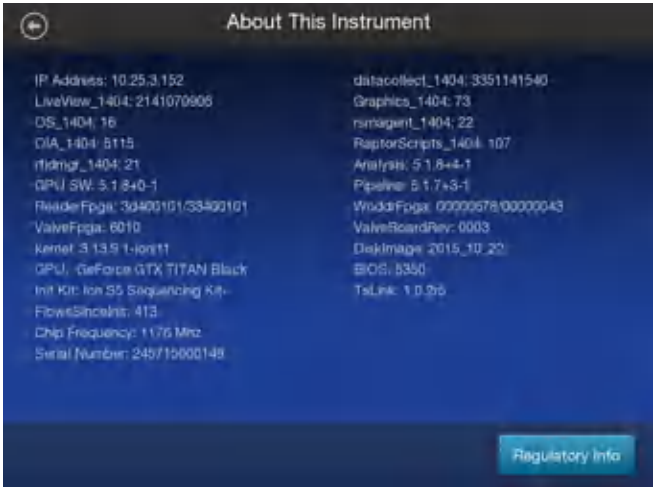
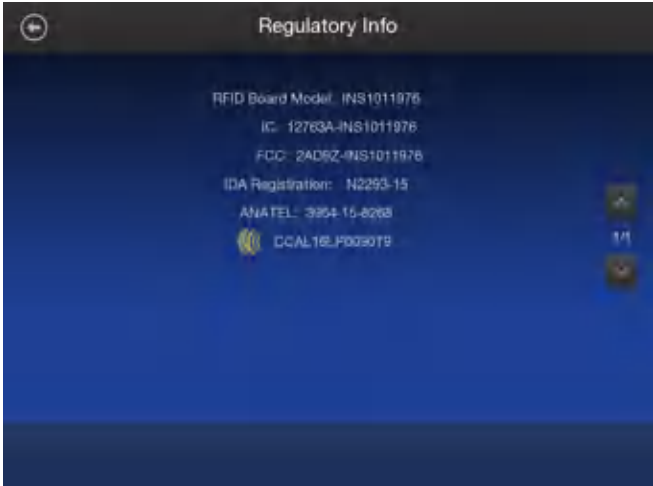

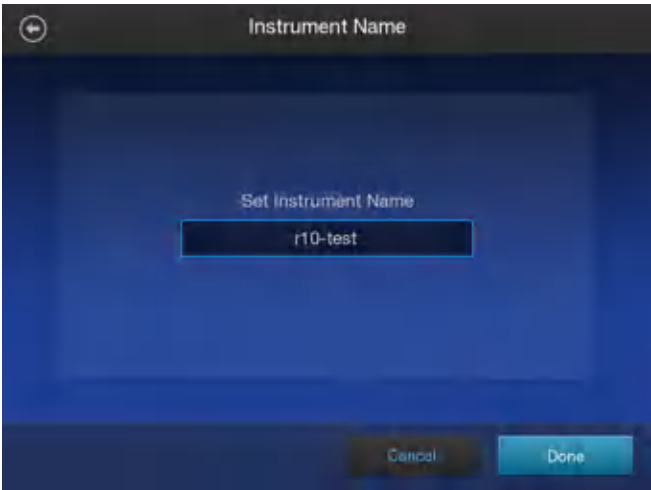
Item	Description	When/How to use
<p>About</p>	<p>Provides instrument details.</p> 	<p>To view instrument reference information or access regulatory information.</p>
<p>Regulatory Info</p>	<p>Lists instrument-specific regulatory information.</p> 	<p>To view instrument regulatory information.</p>







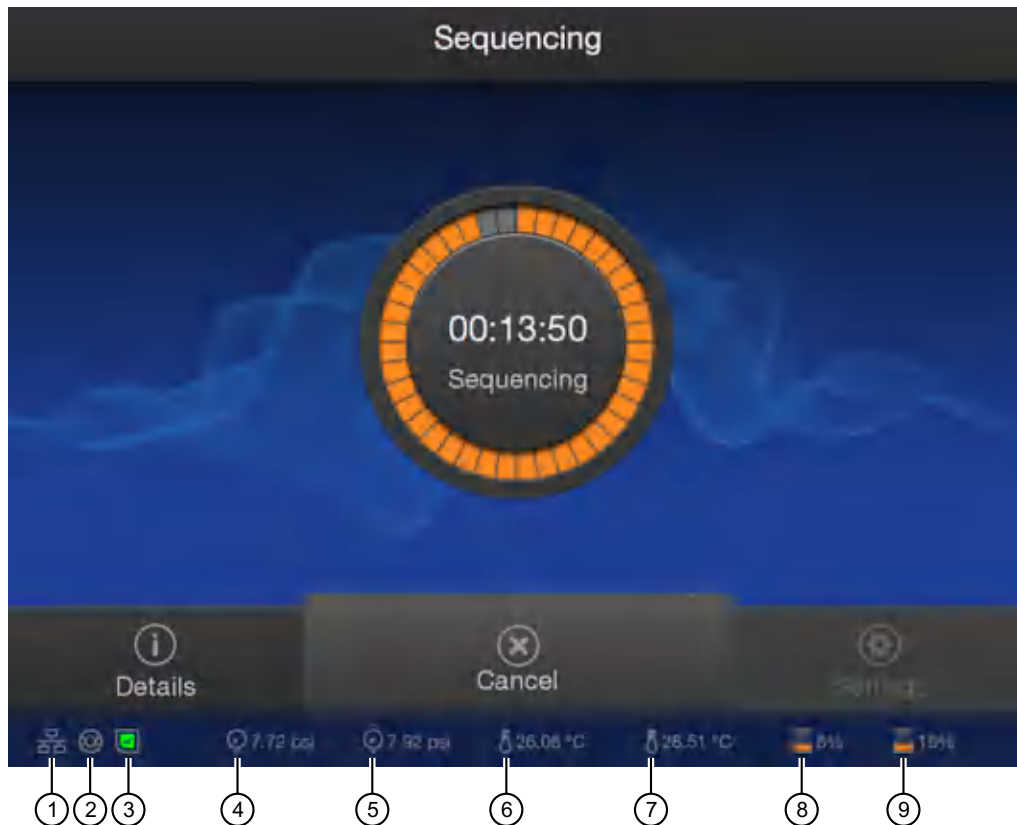

Item	Description	When/How to use
Set Instrument Name		To change the instrument name.
Screen Calibration		<p>For troubleshooting if directed to do so by Technical Support.</p> <p>Touch the red cross with your finger or a stylus each time it appears. In total, you will touch the screen 4 times, once in each corner.</p>

Item	Description	When/How to use
Restore Defaults	<p>Allows users to restore factory default settings.</p> 	<p>To restore factory default settings, press OK.</p>
Service Options	<p>For use by trained service personnel.</p>	<p>For troubleshooting if directed to do so by Technical Support.</p>
Language	<p>To set the user interface language.</p>	<p>Set to customer preference during instrument installation.</p>

Touchscreen icons



Number	Icon	Description
1		Network connectivity – connected
		Network connectivity – not connected
2		Instrument idle
		Sequencing in progress
		Instrument ready
		Error
3		Chip status – Absent
		Chip status – Standby
		Chip status – Connecting
		Chip status – Ready
		Chip status – Imaging
		Chip status – Error
4		Manifold air pressure – Good

Number	Icon	Description
4		Manifold air pressure – Bad. If the icon reads "0" and there is an alarm, contact Technical Support.
5		Regulator air pressure – Good
		Regulator air pressure – Bad. If the icon reads "0" and there is an alarm, contact Technical Support.
6		Manifold temperature – Good
		Manifold temperature – Bad. Check for related alarms. If the alarm persists contact Technical Support.
7		Chip block temperature – Good
		Chip block temperature – Bad. If the icon reads "0" and there is an alarm, contact Technical Support.
8		Instrument File System Space, the percent of file space used is indicated. ^[1] The instrument checks for sufficient disk space before each run and notifies the user if there is not enough.
9		Torrent Server File System Space, the percent of file space used is indicated. Note: If the indicator turns red, archive data from the server to free up disk space. Refer to the Torrent Suite™ Software help for more information on archiving data.

^[1] Indicator turns yellow when disk space is $\geq 67\%$ full, indicator turns red when $\geq 90\%$ full.

Alarms, Notifications, and Events

If the Alarms/Notifications indicator appears, press the indicator to open the **Notifications** screen, then press **Alarms** or **Events** see detailed messages.



① Alarms and Notifications indicator.

Alarm	Description	Recommended Action
Fatal alarms		
Fluidics Calibration Needed.	—	Contact Technical Support.
Chip Cooler can not reach desired temperature.	—	
Drive sdX failed smartctl health check.	Where X is the letter of the drive that failed. Indicates that a drive is failing.	
Failed to mount the results filesystem.	One or more drives are missing from the RAID that makes up sw_results.	
System sensor check failed ipmi - sensors.	A component on the motherboard is failing or has failed.	
System sensor check failed, CC.CC V (LL.LL/HH.HH)	Where CC.CC = current voltage, LL.LL = the low voltage threshold, HH.HH = the high voltage threshold. Indicates a voltage drop on the motherboard.	
CPU temperature check failed, Physical Id X.	Where X is the processor number. Indicates that the processor is over heating.	



Alarm	Description	Recommended Action
Front/Rear FanX speed below threshold YYYY.	Where X is the fan number and YYYY is the low threshold speed for the system fan.	Contact Technical Support.
FPGA failed to connect in emulate mode.	Internal error.	
Valve Link Failure.		
OIA (On Instrument Analysis) is not running.		
FPGA temperature is above the threshold of 70°C.	One or more of the system fans has failed.	
Boot drive exceeded 75%.	The boot drive is unexpectedly full.	
RAID degraded one disk has failed.	One of the Torrent Server drives has failed. System is still operational but must be serviced soon.	
RAID failure detected, more than one disk failed.	More than one of the Torrent Server drives has failed. System is no longer operational.	
/sw_results directory not mounted.	One or more of the drives used during data collection has failed.	
No GPU detected.	GPU has failed.	
No GPU Driver detected.		
Air Compressor failure.	Air compressor is either leaking or has stopped working.	
Non fatal alarms		
Instrument must be cleaned before starting another run.	Maximum number of runs since last clean has been exceeded.	Perform an instrument cleaning. See "Perform the sequencer cleaning manually" on page 16.
Ambient temperature is above the threshold of 35°C.	Verify the temperature in the lab.	Contact Technical Support if the temperature of the lab is within normal operating temperature (20°C to 30°C).
RAID degraded one disk has failed.	One of the Torrent Server drives has failed. System is still operational but must be serviced soon.	Contact Technical Support.
No Connectivity to Torrent Server.	Check that the Ethernet cable connecting the instrument to the server is properly connected, see page 13 for the Ethernet port location.	Reconfigure the Torrent Server as needed, see "Network Settings" on page 20.
No Connectivity to FTP server.		Reconfigure the FTP server as needed, see "Network Settings" on page 20.

Alarm	Description	Recommended Action
Network Manager not connected.	Check that the Ethernet cable connecting the instrument to the local area network is properly connected, see page 13 for the Ethernet port location.	If the problem persists, contact Technical Support.
Newer Software Available	Notification that software updates are available.	Update your software. See “Check for software updates” on page 28.



Troubleshooting

Sequencer alarms and events

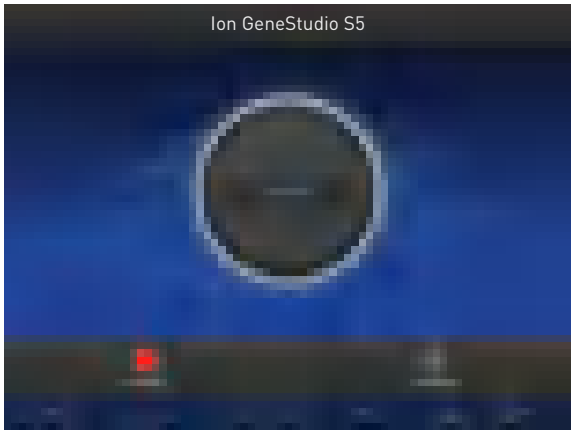
Observation	Possible cause	Recommended action
<p>Red "Alarms" and/or "Events" message in Main Menu</p> 	<ul style="list-style-type: none"> • Available software updates were detected. • Connectivity issues were detected. • Instrument did not detect required files or hardware 	<p>Press the red Alarms icon to see detailed messages.</p> <ul style="list-style-type: none"> • If a message states "Newer Software Available": <p>IMPORTANT! After updates are installed, the instrument must be restarted.</p> <ol style="list-style-type: none"> In the main menu, press Settings ▶ Check for Updates. Select the Released Updates checkbox, then press Update. When installation is complete, follow the onscreen prompts to restart the instrument. <p>Note: In some cases, the instrument restarts automatically after software installation.</p> • If a message states "No Connectivity to Torrent Server", "No Connectivity to ftp server", or "Network Manager not connected", disconnect and re-connect the ethernet cable, confirm that the router is operational, and verify that the network is up and running. • For any other messages: <ol style="list-style-type: none"> Power off the instrument: On the home screen, press Settings ▶ System Tools ▶ Shut Down ▶ Shut Down. Wait 30 seconds, then press the button on the side of the instrument to power on the instrument. • If the red "Alarms" and/or "Events" message still appears in the main menu, contact Technical Support.

Initialization fails

Observation	Possible cause	Recommended action
<p>Chip Check fails</p>	<ul style="list-style-type: none"> • The chip clamp was not closed . • The chip was not properly seated. • The chip was damaged. 	<ol style="list-style-type: none"> 1. Open the chip clamp, remove the chip, and look for signs of water outside the flow cell. 2. If the chip appears damaged, replace it with a new one. 3. Close the clamp, then repeat the Chip Check. 4. If the chip passes, click Next. If the chip fails, replace it with a new chip, then press Chip Check. 5. If Chip Check continues to fail, there could be a problem with the chip socket. Contact Technical Support.
<p>Reagent Check fails</p> 	<p>A chip failure was detected.</p>	<ol style="list-style-type: none"> 1. Replace the used sequencing chip used during initialization with a different used chip. 2. Press Retry. 3. If the initialization completes without failure, touch Home, then continue with your sequencing run. 4. If the Reagent Check continues to fail, contact Technical Support.

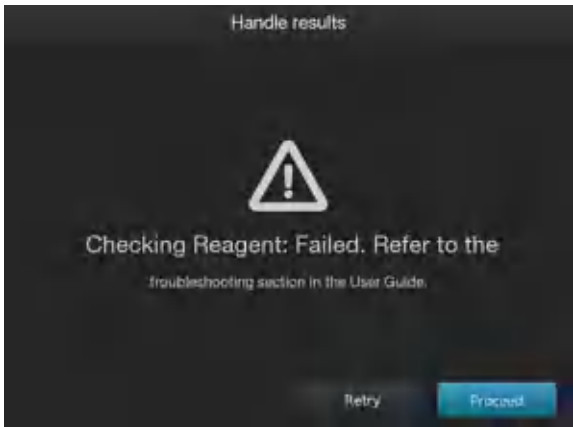
Observation	Possible cause	Recommended action
<p>Reagent Check fails</p> 	<p>A wash failure was detected.</p>	<ol style="list-style-type: none"> 1. Perform a manual cleaning of the sequencer, see page 16. 2. Replace the Reagents cartridge, Wash Solution bottle, and Cleaning Solution bottle, then repeat initialization of the sequencer. 3. If the initialization completes without failure, press Home, then continue with your sequencing run. 4. If the Reagent Check continues to fail, contact Technical Support. <p>Ensure that you install the Ion S5™ Wash Solution bottle with the instrument door fully open. If you install the bottle impeded by a partially closed door, the port can be obstructed, and a faulty installation and wash failure can result.</p>
<p>Bottle leak check fails</p>	<ul style="list-style-type: none"> • Bottle seal was not tight. • Bottle was damaged or defective. 	<ol style="list-style-type: none"> 1. Finger-tighten the bottles. 2. If the bottle continues to leak, replace the bottle. 3. If leak check continues to fail, contact Technical Support.

Troubleshooting using control libraries

Observation	Possible cause	Recommended action
Ion Sphere™ Test Fragments are not present in the Test Fragment Report section of the run report, and library sequencing is poor	<ul style="list-style-type: none"> Chip loading was poor. Control Ion Sphere™ Particles were not added to the sample 	<ol style="list-style-type: none"> Confirm that the Control Ion Sphere™ Particles (included in the Ion S5™ Installation Kit) were added. If controls were added, contact Technical Support.
Control Ion Sphere™ Particles are present in the run report, but AQ20 throughput is poor	<ul style="list-style-type: none"> The quality of the library was poor. The quality of the template preparation was poor. 	<p>Verify the quality of the library and template preparations using quality assessment procedures recommended in the appropriate library and template preparation user guides.</p> <ol style="list-style-type: none"> Use the Human CEPH Genomic DNA Control or Human CEPH Control 200 Library, included in the Ion S5™ Controls Kit (Cat. No. A27760), to prepare template-positive ISPs with the Ion OneTouch™ 2 Instrument, or the Ion Chef™ Instrument. Use the ISPs in an Ion GeneStudio S5 run. If AQ20 throughput is still below specification, verify the quality of unenriched and enriched ISPs to identify a problem in template preparation. If ISP quality is good, but AQ20 throughput is below specification, contact Technical Support.

Troubleshooting using Control Ion Sphere™ Particles

To prepare Control Ion Sphere™ Particles, provided in the Ion S5™ Installation Kit, for an installation or troubleshooting sequencing run:

- Create a Planned Run.
- Clean and initialize the Ion GeneStudio S5 Sequencer.
- Prepare the Control Ion Sphere™ Particles for sequencing:
 - Vortex the control ISPs for 5 seconds, then centrifuge for 2 seconds before taking aliquots.
 - Add 66 µL of control ISPs to an empty 0.2-mL PCR tube (non-polystyrene).
 - Add 150 µL of Ion S5™ Annealing Buffer to the tube.
- Anneal the sequencing primer to the enriched ISPs, then follow the remaining procedures in *Ion 540™ Kit – OT2 User Guide* (Pub. No. MAN0010850) to load a chip and start the sequencing run.

Solid-state buffer leak

Observation	Possible cause	Recommended action
Two or more of the following observed <ul style="list-style-type: none"> Excessive read trimming or the number of short reads is significantly higher than expected. Percentage of low quality reads is significantly higher than expected. Poor sequencing performance or no Test Fragments. 	A solid-state buffer leak occurred.	Contact Technical Support. Perform the pulse cleaning protocol if directed to do so by Technical Support or your Field Service Engineer (FSE).

Pulse clean the sequencer

You should only pulse clean your Ion GeneStudio S5 Sequencer if directed by Technical Support, or your Field Service Engineer (FSE), to recover instrument performance from a diagnosed solid-state buffer leak.

Note: You must contact Technical Support, or your FSE, to diagnose whether a solid-state buffer leak has occurred and obtain the required materials to perform the pulse cleaning.

1. Ensure that the sequencer has completed a normal post-run cleaning. In the main menu:

Display text	Description
Run	Instrument requires cleaning before a pulse cleaning can be performed, see "Perform the sequencer cleaning manually" on page 16.
Clean	Instrument requires cleaning before a pulse cleaning can be performed, see "Perform the sequencer cleaning manually" on page 16.
Initialize	Instrument is ready to be pulse cleaned. Proceed to step 2.

2. Press  (Settings) ▶ System Tools ▶ Pulse clean.

3. Follow the onscreen prompts to prepare the instrument.
 - Install new bottles of Ion S5™ Cleaning Solution in both the Wash and Cleaning solution positions.
 - Replace the Ion S5™ Sequencing Reagents cartridge with an empty used cartridge.
 - Install a used sequencing chip.



4. Close the instrument door, then touch **Next**.

The pulse cleaning procedure begins automatically. The user interface returns to the main menu when the cleaning is complete and the sequencer is ready to be initialized.



Supplemental procedures

Set up and test the Ion Chip™ Minifuge

Note: The Ion Chip™ Minifuge is only required when using the Ion OneTouch™ 2 System for template preparation. Ion Chef™ Instrument users do not require an Ion Chip™ Minifuge.

The Ion Chip™ Minifuge (Cat. No. 4479672 or 4479673) is used to load sequencing chips manually for use on Ion PGM™, Ion Proton™, and Ion GeneStudio S5 sequencing platforms. To accommodate the larger chip size, Ion Proton™ and Ion GeneStudio S5 sequencer users must:

- install the Ion S5™/Ion Proton™ Rotor and Buckets (Cat. No. 4482578).
- test the minifuge to confirm that no liquid is lost during centrifugation.

before using the minifuge to load chips for the first time.

Note: The following protocols may also be used to convert the Ion Chip™ Minifuge back for use with Ion PGM™ sequencing chips.

Install the Ion S5™ /Ion Proton™ Rotor and Buckets

1. Grasp the existing rotor and pull straight up to remove the rotor from the motor shaft.

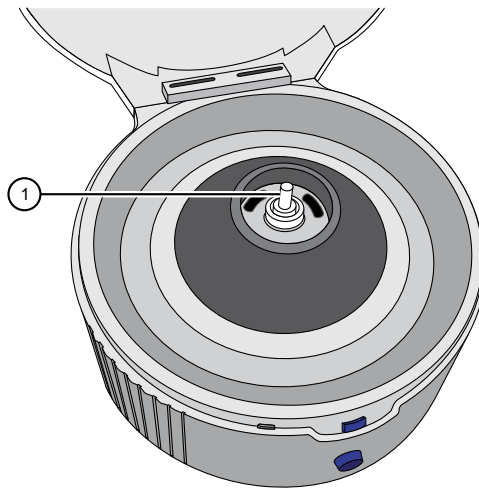

① Motor shaft

2. Press the Ion S5™/Ion Proton™ Rotor down onto the motor shaft to install.

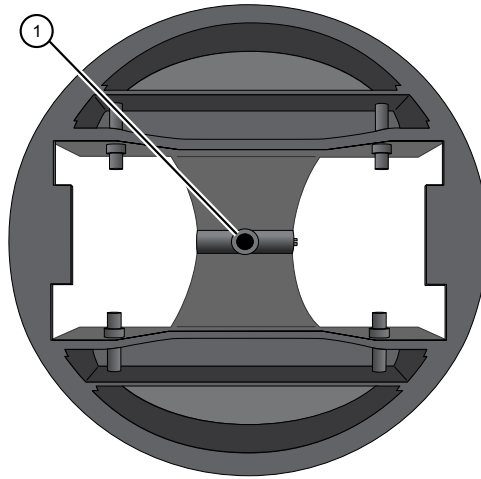

① Insert motor shaft here

3. Tighten the set screw (arrow) with a 1.5-mm hex wrench.

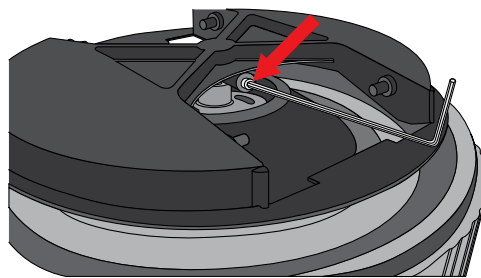

Note: A newer version of the rotor lacks a set screw. In this case, simply press the rotor firmly onto the motor shaft to install.

4. Install the two buckets. Position the buckets with the larger semi-circular cut-outs facing out, and ensure that the buckets hang freely.

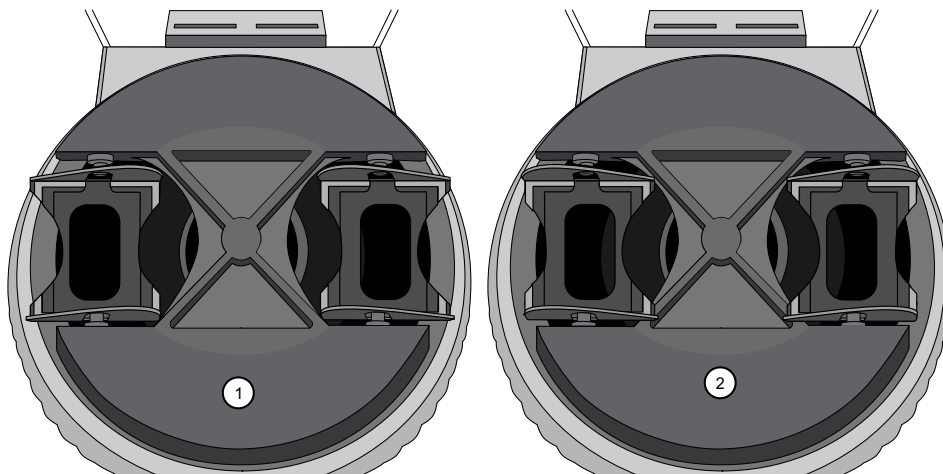

- ① Correct orientation
- ② Incorrect orientation

Test the minifuge

1. Prepare two previously-used chips:
 - a. Inject 100 μL of isopropanol two times into the loading port of each chip. After each injection, remove the expelled liquid from the opposite port.
Note: Use 50 μL volume of isopropanol if testing Ion PGM™ sequencing chips.
 - b. Aspirate the remaining isopropanol from the flow cells for 5–10 seconds. Confirm that the chips are dry.
Note: To aspirate the isopropanol, attach a P200 pipette tip to a vacuum line, then place the pipette tip in the chip loading port.

- Place the two chips prepared in step 1 in the centrifuge buckets, with the chip notch pointing out. Add 55 µL of nuclease-free water to each chip loading well (do not inject into the chip loading port).

Note: Use 35 µL volume of nuclease-free water if testing Ion PGM™ sequencing chips.

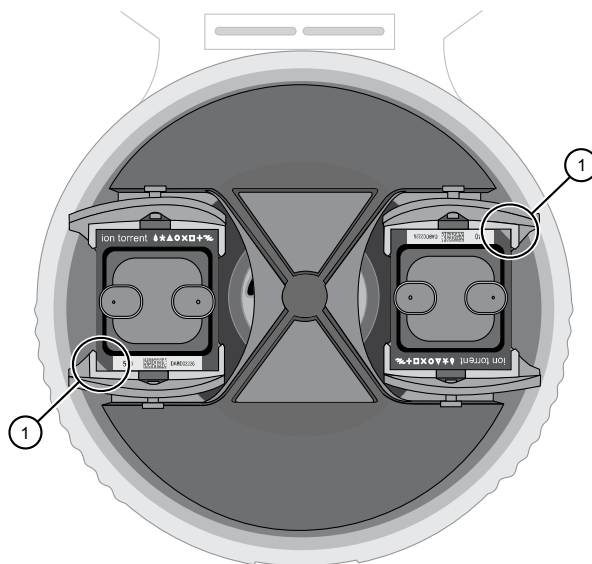

① Chip notch

- Centrifuge for 5–10 seconds, then examine each chip.
The flow cell in each chip should be completely filled with liquid with no air bubbles. A small volume of liquid will remain in the loading well; this is normal.

Result	Action
The chips are NOT completely filled...	Contact Technical Support.
The chips ARE completely filled...	Centrifuge the chips for an additional 10 minutes, then check the chips again for air bubbles, especially near the inlet and outlet ports.
The chips have air bubbles after the additional 10 minute centrifugation...	Contact Technical Support.
The chips remain completely filled...	The centrifuge is ready to use for chip loading.



Instrument warranty

For new Ion Torrent™ instruments, Life Technologies warrants to and only to buyer for twelve (12) months from the date of shipping, that the Ion Torrent™ software and Ion Torrent™ instruments are free from defects in material and workmanship and conform to Life Technologies' published specifications in all material respects. Where a valid and timely claim in respect of breach of Ion Torrent™ warranty is submitted to Life Technologies, Life Technologies may, at its discretion, replace, repair or modify the Ion Torrent™ instrument. Any agreed replacement shall be at 1:1, like-kind basis, at no cost to the buyer. For Ion Torrent™ chips or reagents reasonably determined by Life Technologies to be defective, independent of user error, shall be replaced by Life Technologies on a 1:1, like-kind basis at no cost to buyer, provided that such defective Ion Torrent™ chips or reagents were used by buyer prior to their expiration date, or if there is no expiration date, the Ion Torrent™ chips or reagents were used within six (6) months of receipt, and the defect was promptly reported with appropriate detail to Life Technologies' technical support.

NO OTHER WARRANTIES SHALL BE APPLICABLE TO ION TORRENT PRODUCTS (WHETHER OR NOT ANY FURTHER WARRANTY DOCUMENTATION MAY BE INCLUDED IN THE SHIPMENT), WITH THE EXCEPTION OF THIRD PARTY WARRANTIES WITH RESPECT TO THIRD PARTY PRODUCT. ANY THIRD PARTY PRODUCTS ARE NOT COVERED BY THIS SECTION AND ANY WARRANTIES FOR THIRD PARTY PRODUCTS ARE PROVIDED BY THE ORIGINAL MANUFACTURER OF THE THIRD PARTY PRODUCT. Warranties are made only to buyer purchasing the Ion Torrent™ Product directly from Life Technologies, are not transferable and do not extend to the benefit of any other person or entity, unless otherwise expressly stated in writing by Life Technologies. ANY PRODUCT NOT COVERED BY AN EXPRESS WRITTEN WARRANTY IS SOLD AND PROVIDED "AS IS," WITHOUT WARRANTY OF ANY KIND, STATUTORY, EXPRESS OR IMPLIED. Any description of Ion Torrent™ Product recited in Life Technologies' quotation is for the sole purpose of identifying Ion Torrent™ Product, and any such description is not part of any contract between Life Technologies and buyer and does not constitute a warranty that Ion Torrent™ Product shall conform to that description. Any sample or model used in connection with Life Technologies' quotation is for illustrative purposes only, and is not part of any contract between Life Technologies and buyer and does not constitute a warranty that Ion Torrent™ Product will conform to the sample or model. No affirmation of fact or promise made by Life Technologies, whether or not in Life Technologies' quotation, shall constitute a warranty that Ion Torrent™ Product will conform to the affirmation or promise. Unless otherwise specified in writing in documentation shipped with Ion Torrent™ Product or otherwise agreed by Life Technologies in writing. Life Technologies does not provide service or support for custom products or other products made to buyer's specifications. THE WARRANTIES IDENTIFIED IN THIS CLAUSE ARE LIFE TECHNOLOGIES' SOLE AND EXCLUSIVE WARRANTIES WITH RESPECT TO Ion Torrent™ PRODUCT AND ARE IN LIEU OF ALL OTHER WARRANTIES, STATUTORY, EXPRESS OR IMPLIED, ALL OF WHICH OTHER WARRANTIES ARE EXPRESSLY DISCLAIMED, INCLUDING WITHOUT LIMITATION ANY IMPLIED WARRANTY OF MERCHANTABILITY, FITNESS FOR

A PARTICULAR PURPOSE, NON-INFRINGEMENT, OR REGARDING RESULTS OBTAINED THROUGH THE USE OF ANY PRODUCT (INCLUDING, WITHOUT LIMITATION, ANY CLAIM OF INACCURATE, INVALID OR INCOMPLETE RESULTS), WHETHER ARISING FROM A STATUTE OR OTHERWISE IN LAW OR FROM A COURSE OF PERFORMANCE, DEALING OR USAGE OF TRADE.







Safety

-
-  **WARNING! GENERAL SAFETY.** Using this product in a manner not specified in the user documentation may result in personal injury or damage to the instrument or device. Ensure that anyone using this product has received instructions in general safety practices for laboratories and the safety information provided in this document.
- Before using an instrument or device, read and understand the safety information provided in the user documentation provided by the manufacturer of the instrument or device.
 - Before handling chemicals, read and understand all applicable Safety Data Sheets (SDSs) and use appropriate personal protective equipment (gloves, gowns, eye protection, etc). To obtain SDSs, see the “Documentation and Support” section in this document.
-

Safety alerts on this instrument

Additional text may be used with one of the symbols described above when more specific information is needed to avoid exposure to a hazard. See the following table for safety alerts found on the instrument.

English	Français
 CAUTION! Hazardous chemicals. Read the Safety Data Sheets (SDSs) before handling.	 MISE EN GARDE! Produits chimiques dangereux. Lire les fiches signalétiques (FS) avant de manipuler les produits.
 CAUTION! Hazardous waste. Refer to SDS(s) and local regulations for handling and disposal.	 MISE EN GARDE! Déchets dangereux. Lire les fiches signalétiques (FS) et la réglementation locale associées à la manipulation et à l'élimination des déchets.

Location of safety labels on this instrument

Ion GeneStudio S5 Series sequencers have warnings at the location shown:

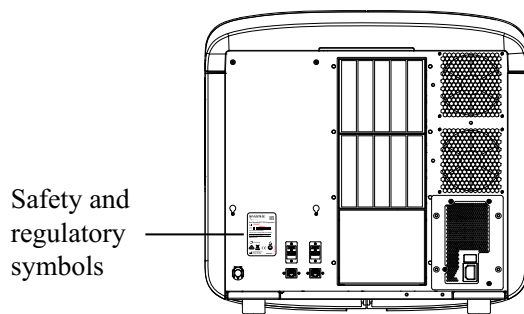

Safety and regulatory symbols

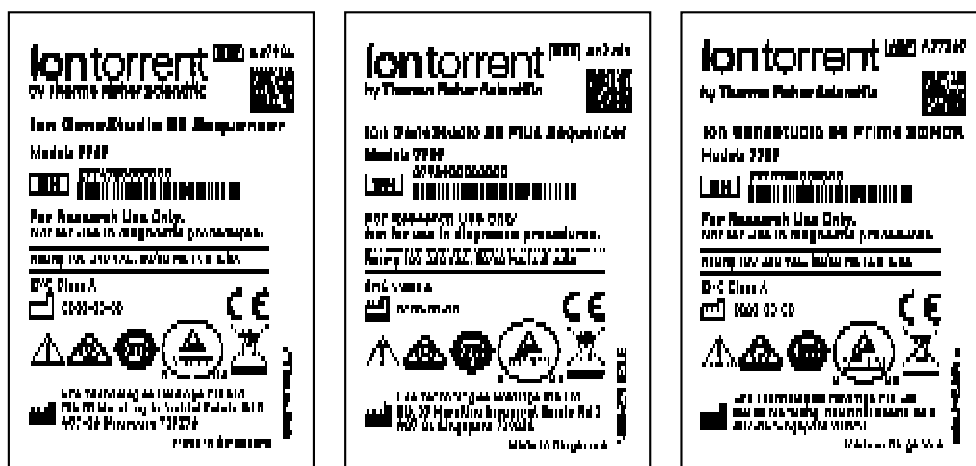

Ion GeneStudio S5 Sequencer labels

Safety information for instruments not manufactured by Thermo Fisher Scientific

Some of the accessories provided as part of the instrument system are not designed or built by Thermo Fisher Scientific. Consult the manufacturer's documentation for the information needed for the safe use of these products.

Instrument safety

General



CAUTION! Do not remove instrument protective covers. If you remove the protective instrument panels or disable interlock devices, you may be exposed to serious hazards including, but not limited to, severe electrical shock, laser exposure, crushing, or chemical exposure.

Cleaning and decontamination



CAUTION! Cleaning and Decontamination. Use only the cleaning and decontamination methods specified in the manufacturer's user documentation. It is the responsibility of the operator (or other responsible person) to ensure the following requirements are met:

- No decontamination or cleaning agents are used that could cause a HAZARD as a result of a reaction with parts of the equipment or with material contained in the equipment.
 - The instrument is properly decontaminated a) if hazardous material is spilled onto or into the equipment, and/or b) prior to having the instrument serviced at your facility or sending the instrument for repair, maintenance, trade-in, disposal, or termination of a loan (decontamination forms may be requested from customer service).
 - Before using any cleaning or decontamination methods (except those recommended by the manufacturer), users should confirm with the manufacturer that the proposed method will not damage the equipment.
-



CAUTION! Nettoyage et décontamination. Utiliser uniquement les méthodes de nettoyage et de décontamination indiquées dans la documentation du fabricant destinée aux utilisateurs. L'opérateur (ou toute autre personne responsable) est tenu d'assurer le respect des exigences suivantes:

- Ne pas utiliser d'agents de nettoyage ou de décontamination susceptibles de réagir avec certaines parties de l'appareil ou avec les matières qu'il contient et de constituer, de ce fait, un DANGER.
 - L'instrument doit être correctement décontaminé a) si des substances dangereuses sont renversées sur ou à l'intérieur de l'équipement, et/ou b) avant de le faire réviser sur site ou de l'envoyer à des fins de réparation, de maintenance, de revente, d'élimination ou à l'expiration d'une période de prêt (des informations sur les formes de décontamination peuvent être demandées auprès du Service clientèle).
 - Avant d'utiliser une méthode de nettoyage ou de décontamination (autre que celles recommandées par le fabricant), les utilisateurs doivent vérifier auprès de celui-ci qu'elle ne risque pas d'endommager l'appareil.
-

Electrical



WARNING! Ensure appropriate electrical supply. For safe operation of the instrument:

- Plug the system into a properly grounded receptacle with adequate current capacity.
 - Ensure the electrical supply is of suitable voltage.
 - Never operate the instrument with the ground disconnected. Grounding continuity is required for safe operation of the instrument.
-



WARNING! Veiller à utiliser une alimentation électrique appropriée. Pour garantir le fonctionnement de l'instrument en toute sécurité :

- Brancher le système sur une prise électrique correctement mise à la terre et de puissance adéquate.
 - S'assurer que la tension électrique est convenable.
 - Ne jamais utiliser l'instrument alors que le dispositif de mise à la terre est déconnecté. La continuité de la mise à la terre est impérative pour le fonctionnement de l'instrument en toute sécurité.
-



WARNING! Power Supply Line Cords. Use properly configured and approved line cords for the power supply in your facility.



WARNING! Cordons d'alimentation électrique. Utiliser des cordons d'alimentation adaptés et approuvés pour raccorder l'instrument au circuit électrique du site.



WARNING! Disconnecting Power. To fully disconnect power either detach or unplug the power cord, positioning the instrument such that the power cord is accessible.



WARNING! Déconnecter l'alimentation. Pour déconnecter entièrement l'alimentation, détacher ou débrancher le cordon d'alimentation. Placer l'instrument de manière à ce que le cordon d'alimentation soit accessible.



Safety and electromagnetic compatibility (EMC) standards

The instrument design and manufacture complies with the standards and requirements for safety and electromagnetic compatibility as noted in the following table:

Safety

Reference	Description
EU Directive 2014/35/EU	European Union “Low Voltage Directive”
IEC 61010-1 UL 61010-1 CSA C22.2 No. 61010-1	<i>Safety requirements for electrical equipment for measurement, control, and laboratory use – Part 1: General requirements</i>
IEC 61010-2-010	<i>Safety requirements for electrical equipment for measurement, control and laboratory use – Part 2-010: Particular requirements for laboratory equipment for the heating of materials</i>

EMC

Reference	Description
Directive 2014/30/EU	European Union “EMC Directive”
EN 61326-1	<i>Electrical Equipment for Measurement, Control and Laboratory Use – EMC Requirements – Part 1: General Requirements</i>
AS/NZS CISPR 22 2009+A1 2010	<i>Limits and Methods of Measurement of Electromagnetic Disturbance Characteristics of Industrial, Scientific, and Medical (ISM) Radiofrequency Equipment</i>
ICES-003, Issue 5	<i>Industrial, Scientific and Medical (ISM) Radio Frequency Generators</i>
FCC Part 15 Subpart B (47 CFR)	<i>U.S. Standard Radio Frequency Devices</i>

Environmental design

Waste and hazardous substances

Reference	Description
Directive 2012/19/EU	European Union “WEEE Directive” – Waste electrical and electronic equipment
Directive 2011/65/EU	European Union “RoHS Directive” – Restriction of hazardous substances in electrical and electronic equipment

Radio compliance

Reference	Description
Directive 2014/53/EU	European Radio Equipment Directive (RED)
RFID	<p><i>FCC Notice (for U.S. Customers):</i></p> <p>This device complies with Part 15 of the FCC Rules.</p> <p>Operation is subject to the following conditions:</p> <ol style="list-style-type: none"> 1. This device may not cause harmful interference, and 2. This device must accept any interference received, including interference that may cause undesired operation <p>Changes and Modifications not expressly approved by Thermo Fisher Scientific can void your authority to operate this equipment under Federal Communications Commission rules.</p> <p>Canada:</p> <p><i>This device complies with Industry Canada licence-exempt RSS standard(s).</i> Operation is subject to the following two conditions: (1) this device may not cause interference, and (2) this device must accept any interference, including interference that may cause undesired operation of the device.</p> <p>Le présent appareil est conforme aux CNR d'Industrie Canada applicables aux appareils radio exempts de licence. L'exploitation est autorisée aux deux conditions suivantes : (1) l'appareil ne doit pas produire de brouillage, et (2) l'utilisateur de l'appareil doit accepter tout brouillage radioélectrique subi, même si le brouillage est susceptible d'en compromettre le fonctionnement.</p>

Chemical safety



WARNING! GENERAL CHEMICAL HANDLING. To minimize hazards, ensure laboratory personnel read and practice the general safety guidelines for chemical usage, storage, and waste provided below. Consult the relevant SDS for specific precautions and instructions:

- Read and understand the Safety Data Sheets (SDSs) provided by the chemical manufacturer before you store, handle, or work with any chemicals or hazardous materials. To obtain SDSs, see the “Documentation and Support” section in this document.
- Minimize contact with chemicals. Wear appropriate personal protective equipment when handling chemicals (for example, safety glasses, gloves, or protective clothing).
- Minimize the inhalation of chemicals. Do not leave chemical containers open. Use only with adequate ventilation (for example, fume hood).
- Check regularly for chemical leaks or spills. If a leak or spill occurs, follow the manufacturer's cleanup procedures as recommended in the SDS.
- Handle chemical wastes in a fume hood.
- Ensure use of primary and secondary waste containers. (A primary waste container holds the immediate waste. A secondary container contains spills or leaks from the primary container. Both containers must be compatible with the waste material and meet federal, state, and local requirements for container storage.)
- After emptying a waste container, seal it with the cap provided.
- Characterize (by analysis if necessary) the waste generated by the particular applications, reagents, and substrates used in your laboratory.
- Ensure that the waste is stored, transferred, transported, and disposed of according to all local, state/provincial, and/or national regulations.
- **IMPORTANT!** Radioactive or biohazardous materials may require special handling, and disposal limitations may apply.



WARNING! PRÉCAUTIONS GÉNÉRALES EN CAS DE MANIPULATION DE PRODUITS CHIMIQUES. Pour minimiser les risques, veiller à ce que le personnel du laboratoire lise attentivement et mette en œuvre les consignes de sécurité générales relatives à l'utilisation et au stockage des produits chimiques et à la gestion des déchets qui en découlent, décrites ci-dessous. Consulter également la FDS appropriée pour connaître les précautions et instructions particulières à respecter :

- Lire et comprendre les fiches de données de sécurité (FDS) fournies par le fabricant avant de stocker, de manipuler ou d'utiliser les matériaux dangereux ou les produits chimiques. Pour obtenir les FDS, se reporter à la section « Documentation et support » du présent document.
- Limiter les contacts avec les produits chimiques. Porter des équipements de protection appropriés lors de la manipulation des produits chimiques (par exemple : lunettes de sûreté, gants ou vêtements de protection).
- Limiter l'inhalation des produits chimiques. Ne pas laisser les récipients de produits chimiques ouverts. Ils ne doivent être utilisés qu'avec une ventilation adéquate (par exemple, sorbonne).

- Vérifier régulièrement l'absence de fuite ou d'écoulement des produits chimiques. En cas de fuite ou d'écoulement d'un produit, respecter les directives de nettoyage du fabricant recommandées dans la FDS.
 - Manipuler les déchets chimiques dans une sorbonne.
 - Veiller à utiliser des récipients à déchets primaire et secondaire. (Le récipient primaire contient les déchets immédiats, le récipient secondaire contient les fuites et les écoulements du récipient primaire. Les deux récipients doivent être compatibles avec les matériaux mis au rebut et conformes aux exigences locales, nationales et communautaires en matière de confinement des récipients.)
 - Une fois le récipient à déchets vidé, il doit être refermé hermétiquement avec le couvercle fourni.
 - Caractériser (par une analyse si nécessaire) les déchets générés par les applications, les réactifs et les substrats particuliers utilisés dans le laboratoire.
 - Vérifier que les déchets sont convenablement stockés, transférés, transportés et éliminés en respectant toutes les réglementations locales, nationales et/ou communautaires en vigueur.
 - **IMPORTANT !** Les matériaux représentant un danger biologique ou radioactif exigent parfois une manipulation spéciale, et des limitations peuvent s'appliquer à leur élimination.
-

Documentation and support

Related documentation

Title	Pub. No.
<i>Ion 510™ & Ion 520™ & Ion 530™ Kit – Chef User Guide</i>	MAN0016854
<i>Ion 540™ Kit – Chef User Guide</i>	MAN0010851
<i>Ion 550™ Kit – Chef User Guide</i>	MAN0017275
<i>Ion 520™ & Ion 530™ ExT Kit – Chef User Guide</i>	MAN0015805
<i>Ion 520™ & Ion 530™ Kit – OT2 User Guide</i>	MAN0010844
<i>Ion 540™ Kit – OT2 User Guide</i>	MAN0010850
<i>Ion GeneStudio S5 System Site Preparation Guide</i>	MAN0017529

Customer and technical support

Visit thermofisher.com/support for the latest in services and support, including:

- Worldwide contact telephone numbers
- Product support, including:
 - Product FAQs
 - Software, patches, and updates
 - Training for many applications and instruments
- Order and web support
- Product documentation, including:
 - User guides, manuals, and protocols
 - Certificates of Analysis
 - Safety Data Sheets (SDSs; also known as MSDSs)

Note: For SDSs for reagents and chemicals from other manufacturers, contact the manufacturer.

