

Thermo Scientific Wellwash

User Manual

Rev. 1.1, Cat. No. N15777



Copyright

© 2014 Thermo Fisher Scientific Inc. All rights reserved. Decon is a trademark of Decon Laboratories Limited. Microside SQ is a registered trademark of Global Biotechnologies, Inc. Tween is a trademark of ICI Americas Inc. Virkon is a trademark of E.I. du Pont de Nemours and Company or its affiliates. All (other) trademarks are the property of Thermo Fisher Scientific Inc. and its subsidiaries. Reproduction of the accompanying user documentation in whole or in part is prohibited.

Disclaimer

Thermo Fisher Scientific reserves the right to change its products and services at any time to incorporate technological developments. This manual is subject to change without prior notice as part of continuous product development. Although this manual has been prepared with every precaution to ensure accuracy, Thermo Fisher Scientific assumes no liability for any errors or omissions, nor for any damages resulting from the application or use of this information. This manual supersedes all previous editions.

Remarks on screenshots

The version number displayed in screenshots may not always be the one of the currently released version.

No liability for consequential damages

Thermo Fisher Scientific shall not be liable for any indirect or consequential damages whatsoever arising out of the use or inability to use this product.

Power failure

The system requires uninterrupted power supply in order to operate correctly. Thermo Fisher Scientific has no responsibility whatsoever for system malfunctions arising from power failures.

Warranty

The Thermo Scientific Microplate Instrumentation products are fully guaranteed against defective parts and materials, including defects caused by poor workmanship for a period of one year from the date of delivery.

Thermo Fisher Scientific will repair or replace defective parts or materials during the term of warranty at no extra charge for materials and labor provided that the products were used and maintained in accordance with instructions from Thermo Fisher Scientific. The warranty is invalid if products have been misused or abused.

For the warranty to be effective, the product must have been purchased either directly from Thermo Fisher Scientific or from an authorized Thermo Fisher Scientific distributor. The guarantee is not transferable to a third party without prior written approval from Thermo Fisher Scientific.

This guarantee is subject to the following exclusions:

- Any defects caused by normal wear and tear.
- Defects caused by fire, lightning, flood, earthquake, explosion, sabotage, war, riot or any other occurrence of the character listed above.
- Refurbished products that are subject to different warranty conditions.

THIS WARRANTY IS IN LIEU OF ALL OTHER EXPRESSED OR IMPLIED WARRANTIES, INCLUDING BUT NOT LIMITED TO ANY IMPLIED WARRANTIES OF MERCHANTABILITY OR FITNESS FOR A PARTICULAR PURPOSE. The seller is not liable for any loss or damage arising out of or in connection with the use of the product or other indirect damages.

Cat. No. N15777
February 2014

(This translation corresponds to the original master document *Thermo Scientific™ Wellwash™ User Manual*, Cat. No. N15777, Rev. 1.1.)

About This User Manual

Intended users

The Thermo Scientific™ Wellwash™ microplate washer can be used as standalone in research and routine-test laboratories by professional personnel.

How to use this user manual

This user manual is for the following instruments: Wellwash 1x8, Cat. No. 5165000, and Wellwash 1x12, Cat. No. 5165040. It has been written to give you the information you need to:

- Review safety precautions
- Install the Wellwash
- Navigate and edit in the Wellwash user interface
- Operate the instrument
- Make and run wash protocols
- Define wash parameters
- Perform cleaning and maintenance procedures
- Troubleshoot the instrument performance

This user manual also describes all the features and specifications of the Wellwash instrument as well as ordering information.

Read the manual in its entirety before operating the instrument.







Keep the user manual on the CD provided for future reference. The user manual is an important part of the instrument and should be readily available during use of the instrument. Keep the user manual together with the instrument in case you distribute it onwards.

Safety symbols and markings

These symbols are intended to draw your attention to particularly important information and alert you to the presence of hazards as indicated.

Safety symbols and markings used on the Wellwash

The following symbols and markings appear on the type label and the instrument itself.

-  **Power ON**
-  **Power OFF**
-  **Serial number**
-  **Catalog number**
-  **Date of manufacture**
-  **Consult instructions for use**
-  **WEEE symbol!** This product is required to comply with the European Union's Waste Electrical & Electronic Equipment (WEEE) Directive 2012/19/EC.

Warning and other markings used in the documentation

The following symbols and markings appear in this user manual.





-  **Warning!** Risk of electric shock.
-  **Warning!** Biohazard risk.
-  **Warning!** Risk of injury to the user(s).
-  **Caution!** Risk of damage to the instrument, other equipment or loss of performance or function in a specific application.
-  **Note!** Marks a hint, important information that is useful in the optimum operation of the system, or an item of interest.

Table of Contents

Chapter 1: Introduction to the Wellwash Microplate Washer	8
<i>Intended use</i>	8
<i>Principle of operation</i>	9
Chapter 2: Installation	10
<i>Unpacking</i>	10
How to unpack	10
Checking delivery for completeness or damage	10
Environmental requirements	10
<i>Setups</i>	11
Releasing the transport lock	11
Installing the priming vessel	12
Installing the wash head	12
Liquid bottles and channels	14
<i>Connection diagram</i>	15
<i>Installing the liquid bottles</i>	16
<i>Foaming</i>	17
Connecting the power supply cable	18
<i>USB port for PC</i>	18
<i>Warnings and cautions</i>	18
Electrical	18
Defects and abnormal stresses	19
<i>Operating precautions and limitations before operation</i>	19
<i>Mechanical checks before switching on</i>	20
Installing the aerosol cover	20
<i>Switching on</i>	21
<i>Performing the operational check after switching on</i>	21
<i>Settings after installation</i>	21
Chapter 3: Wellwash Main Parts	22
<i>Front view</i>	22
<i>Back view</i>	22
<i>Side views</i>	23
<i>Liquid system diagram</i>	23
<i>USB memory device port</i>	23
<i>USB PC port</i>	24
<i>Plate carrier</i>	24
<i>Wash heads</i>	24
<i>Shaker</i>	24
Chapter 4: Operating the Instrument	25
<i>Display and keys for navigating and editing</i>	25
<i>Menus</i>	26
<i>Main menu</i>	27
Liquid level detection	27
Chapter 5: Running Protocols	28
<i>General operating procedure for running a protocol</i>	28
<i>Filling and emptying liquid bottles</i>	29
<i>Starting ready-made protocols</i>	29
Starting a ready-made protocol with the quick keys (F1-F3)	29
Starting a ready-made protocol from the list	30
<i>Loading the plate</i>	30
<i>Priming the system</i>	32
<i>Strip selection</i>	32
Strip selection with the number keys	32
Strip selection with the Layout row	33
<i>Starting a run</i>	34
<i>Canceling a run</i>	34

Chapter 6: Menu, Tabs and Parameters	35
Menu.....	35
Main menu/tab	35
Protocol.....	35
<i>Creating a protocol</i>	36
<i>Creating a protocol in an optional way</i>	39
<i>Adding new steps to protocols</i>	40
<i>Deleting steps from protocols</i>	41
Head / Plate	42
Well.....	42
<i>Microplate requirements</i>	44
Steps.....	44
Wash.....	45
Aspirate.....	47
Dispense.....	48
Soak.....	49
Prime.....	49
Pause.....	50
Layout.....	50
Settings menu.....	52
Prime parameters.....	52
Sensors.....	53
Wash head configuration.....	54
System.....	55
Reports	55
Maintenance menu	56
Clean	56
<i>Cleaning/Disinfection procedure</i>	57
<i>Clean wash head</i>	59
<i>Soak wash head</i>	60
<i>Move wash head</i>	61
<i>Empty priming vessel</i>	62
Calibration.....	63
<i>Starting the calibration</i>	63
<i>Active calibration</i>	64
<i>Calibrate current wash head</i>	64
Service.....	68
Chapter 7: Exporting and Importing	69
<i>Exporting a protocol</i>	69
<i>Importing a protocol</i>	70
<i>Exporting protocols as text files</i>	71
Chapter 8: Deleting.....	72
<i>Deleting a protocol</i>	72
Chapter 9: Shutdown	73
<i>Shutting down</i>	73
Chapter 10: Emergency Situations	74
<i>Handling abnormal situations</i>	74
Chapter 11: Maintenance.....	74
<i>Regular and preventive maintenance</i>	74
Maintenance checklist.....	75
Instrument care	75
<i>Cleaning of the instrument</i>	76
Salt deposit	76
<i>Cleaning the priming vessel</i>	77
<i>Cleaning the plate carrier</i>	77
<i>Cleaning liquid bottles</i>	78
<i>Checking the liquid level sensors</i>	79
<i>Autoclavation</i>	79

<i>Cleaning the wash head</i>	79
Mechanical cleaning of the wash head.....	80
<i>Changing or replacing the wash head</i>	80
<i>Checking the liquid line</i>	80
<i>Checking the residual volume</i>	80
<i>Checking the dispense accuracy</i>	80
<i>Checking the aspirate height</i>	81
<i>Manual priming</i>	81
<i>Disposal of materials</i>	81
<i>Decontamination procedure</i>	82
<i>Refitting the transport lock</i>	83
<i>Maintaining a system log</i>	84
<i>Packing for service</i>	84
<i>Disposal of the instrument</i>	85
Chapter 12: Technical Specifications	85
<i>General specifications</i>	85
<i>Performance specifications</i>	86
<i>Safety specifications</i>	87
In conformity with the requirements.....	87
Chapter 13: Troubleshooting Guide	87
<i>Error and warning codes</i>	87
<i>USB memory device</i>	89
<i>Troubleshooting guide</i>	89
Chapter 14: Ordering Information	90
<i>Wellwash</i>	90
<i>List of spare parts and accessories</i>	91
Appendix A: System Log	92
Appendix B: Certificate of Decontamination	93

Chapter 1: Introduction to the Wellwash Microplate Washer

The Wellwash (Figure 1) is a microplate washer. It is designed to use a 96-well plate format in both landscape and portrait orientation. The 96-well plates and strips are designed to be washed in 1x8 or 1x12 format. The instrument allows shaking. The instrument is controlled through the built-in graphical user interface and keypad. The Wellwash can be used to wash and prepare plates for a variety of test routines, mainly in enzyme-linked immunosorbent assay (ELISA) tests.

The Wellwash is available in the following configurations:

- Wellwash 1x8 100–240V 50/60Hz (Cat. No. 5165000)
 - 96-well plate washing in landscape mode
- Wellwash 1x12 100–240V 50/60Hz (Cat. No. 5165040)
 - 96-well plate washing in portrait mode



Figure 1. Wellwash microplate washer

Intended use

The Wellwash is a microplate strip washer intended for automated washing of 96-well plates and strips that meet ANSI/SBS standards.

The instrument can be used in research or routine-test laboratories by professional personnel in enzyme-linked immunosorbent assays (ELISA).

As the Wellwash is part of an analyzing system for the end user, the user is responsible for validation of the whole system to enable production of reliable and safe results. If the assay performance is essential to the analysis, the test result has to be assured using internal quality controls or an alternative test.

It is recommended to follow Good Laboratory Practice (GLP) during the analyzing process.

Use for self-testing is excluded.

Principle of operation

The Wellwash can be used to wash and prepare plates for a variety of test routines, mainly in ELISA applications. The Wellwash (Figure 1) is a microplate strip washer for automated washing, aspiration, dispensing and shaking of 96-well plates and strips in landscape or portrait plate orientation. The instrument is equipped with one wash and one waste liquid bottle each with a cap, tubing and a liquid level sensor. The Wellwash comes with a 1x8 or a 1x12 wash head. The plate carrier places the microplate under the wash head to perform the desired operation. During priming the wash head moves into the priming vessel to fill the liquid line from the liquid bottle to the wash head.

The 96-well plates and strips are designed to be washed with a 1x8 wash head (landscape) or a 1x12 wash head (portrait) (Figure 2). The wash head tips have both dispensing and aspiration channels. In the washing step, the wash head aspirates continuously and descends until it reaches the bottom of the well and the liquid is aspirated (Figure 3). In sweep mode, the wash head aspirates in two positions of the well bottom to enable a low residual volume (Figure 4). When the wash head is in the upper position, the desired volume is dispensed into the well (Figure 3 and Figure 4). Aspiration runs continuously, enabling overflow dispensing of large volumes. After the first row or column has been washed, the next row or column is moved under the wash head for washing.



Figure 2. Wash heads



Figure 3. Principle of Wash step (Normal)



Figure 4. Principle of Wash step (Sweep2)

Chapter 2: Installation



Warning! The Wellwash weighs 8 kg [17.6 lbs.] and care must be taken when lifting it.

For more information on main parts of the instrument, refer to Chapter 3: “Wellwash Main Parts”.

Unpacking

How to unpack

Move the packed instrument to its site of operation. To prevent condensation, the instrument should be left in its protective plastic wrapping until the ambient temperature has been reached. Unpack the Wellwash instrument and accessories carefully with the arrows on the transport package pointing upwards. Place the instrument onto a laboratory bench.



Caution! Do not touch or loosen any screws or parts other than those specifically designated in the instructions. Doing so may cause misalignment and will void the instrument warranty.

Retain the original packaging for future transportation. The packaging is designed to assure safe transport and minimize transit damage. Using other packaging materials may invalidate the warranty. Also retain all instrument-related documentation provided by the manufacturer for future use.

If you relocate your instrument or ship it for service, refer to “How to pack for service”.

Checking delivery for completeness or damage

Check the enclosed packing list against the order. Visually inspect the transport packaging, the instrument and the accessories for any possible transport damage. If any parts are missing or damaged, contact your local Thermo Fisher Scientific representative or Thermo Fisher Scientific Oy.



Caution! If the instrument has been mechanically damaged, ship it for service.

Environmental requirements

When you set up your Wellwash, avoid sites with excess dust, vibrations, strong magnetic fields, direct sunlight, draft, excessive moisture or large temperature fluctuations. Make sure that:

- The working area is flat, dry, clean and vibration-proof, and leave additional room for cables, covers, and so on.
- There is at least 10 cm of free space around the instrument on the laboratory bench for ventilation.
- There is sufficient room behind the instrument to enable disconnecting the device.
- The ambient air is clean and free of corrosive vapors, smoke and dust.
- The ambient temperature range is between +10°C (50°F) and +40°C (104°F).
- The humidity is low so that condensing does not occur (relative humidity is between 10% and 80%, non-condensing).



Caution! Do not operate the instrument in an environment where potentially damaging liquids or gases are present.

Setups



Warning! All parts of the instrument that come into contact with potentially infectious materials must be treated as potentially infectious areas.

It is advisable to adhere to applicable safety precautions, such as the wearing of disposable powder-free gloves, safety glasses, and protective clothing, to avoid potential infectious disease contamination when performing cleaning procedures and also when making adjustments to the instrument.



Caution! Leave the instrument to sit for at least three hours before installing and switching it on to prevent condensation causing a short circuit.

Releasing the transport lock



Caution! Make sure that the transport lock has been removed and that the priming vessel, the wash head, and the liquid bottles with tubes and liquid level detectors have been installed before you put the instrument into operation.

1. Remove the padded packing material protecting the wash head arm and plate carrier to reveal the transport lock and transport lock tag (Figure 5). Also remove the plastic transport protection bag.

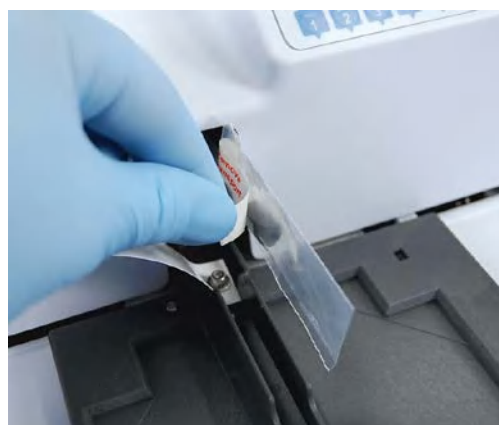

Figure 5. Transport lock and transport lock tag

2. Unfasten the transport lock screw using the Allen key supplied (Figure 6).

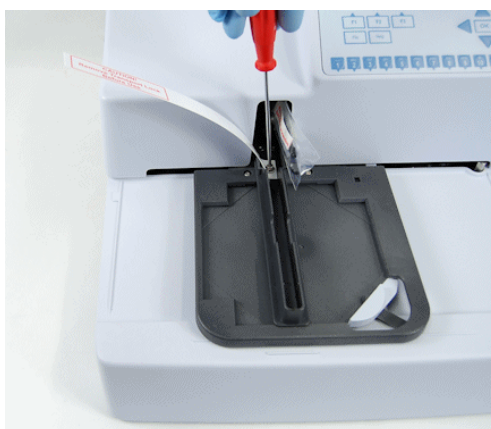

Figure 6. Unfastening the transport lock

3. Keep the transport lock and tag for future relocation or transportation of the instrument.

Installing the priming vessel

The instrument comes with the priming vessel installed. The priming vessel is correctly installed if it stays in place and does not move up. If the priming vessel is not installed, insert it downwards and pull it towards yourself (Figure 7).



Figure 7. Priming vessel installation



Warning! The priming vessel may be contaminated after the instrument has been used.

Installing the wash head

The wash head is packed separately and must be installed before use. Keep the wash head package for storage purposes. If the wash head is not used, place it first into the enclosed plastic bag and then into the original package. The wash head supplied with the instrument is calibrated at the factory. The wash head box includes an instrument serial number according to which it has been calibrated at the factory. Optional wash heads must be calibrated by the user prior to use.



Warning! The wash head may be contaminated after the instrument has been used.



Warning! Failing to connect the dispensing or aspiration tube may cause spillage.



Caution! Only use wash heads that have an identification label.



Note! Always wear disposable powder-free gloves when handling the wash heads.



Note! Do not remove the lot number sticker on the wash head.

1. The instrument is supplied with a 1x8 or 1x12 wash head depending on the model.
2. Fit the supplied wash head tightly to the tubing according to Figure 8 and Figure 9. Note the difference in sizes.
 - The larger aspiration (waste) tube is connected to the bottom hole.
 - The smaller dispensing tube is connected to the top hole.
 - Apply silicone grease to the O-rings of the connectors if needed.



Figure 8. Available wash heads (A) as well as aspiration and dispensing tubes (B)

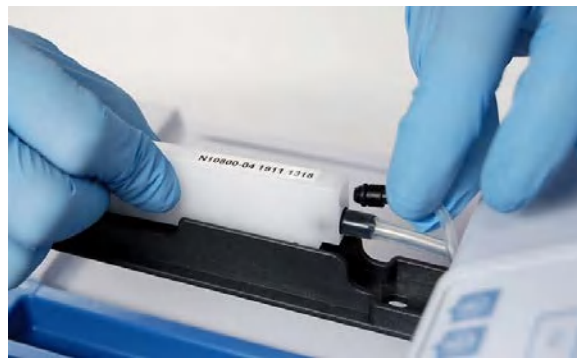

Figure 9. Fitting the wash head to the connectors

3. Fit the wash head onto the wash head arm with the tips pointing downwards and ensure that the wash head moves freely up and down in the wash head arm slot (Figure 10).

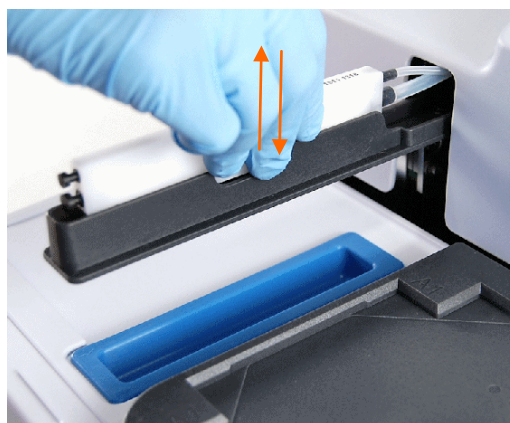

Figure 10. Fitting the 1x8 wash head onto the wash head arm

4. Check that the wash head is properly inserted (Figure 11).



Figure 11. 1x8 wash head properly inserted

5. Check that the wash head configuration in the **Settings** menu corresponds to the installed wash head.
6. If you are replacing the wash head, you must calibrate the wash head. Refer to “Calibrate current wash head”.
7. If you are changing the wash head to another type, first change the Wash head type and then calibrate the wash head.

Liquid bottles and channels

The Wellwash includes one standard buffer bottle (2 liters) and one waste bottle (2 liters).

The liquid channels are: **A** (for Buffer A) and **W** (for Waste).

The liquid bottles are named and the tubing is color coded to correspond to the correct buffer source (**A = blue** and **W = colorless**) (Figure 12). Refer to “Connection diagram”.

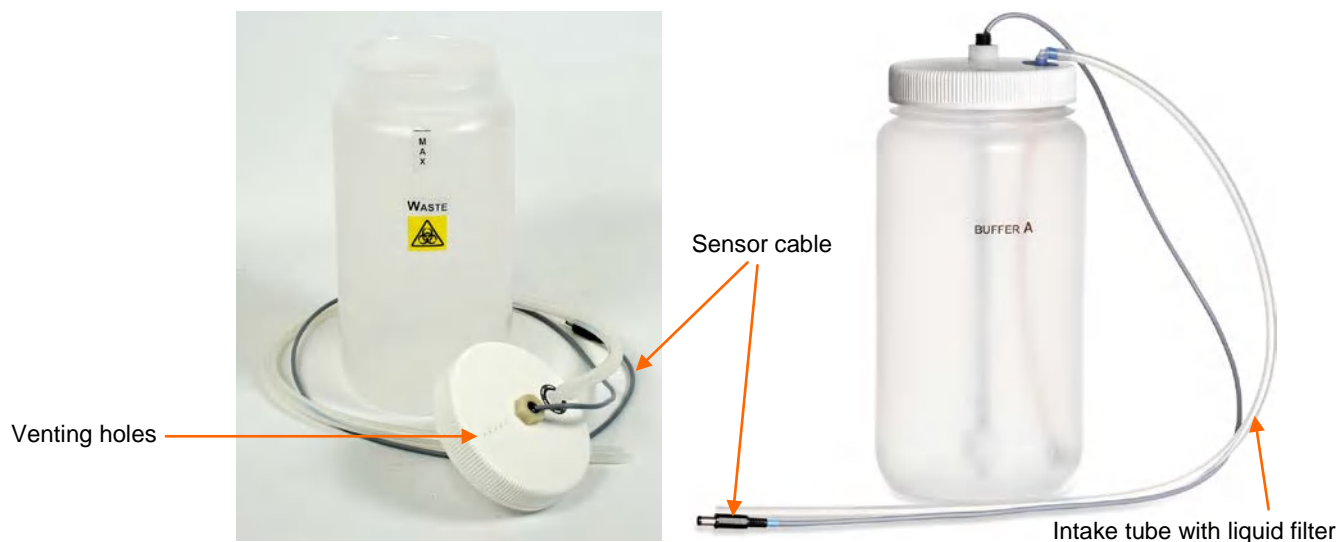

Figure 12. Waste and liquid bottles with liquid level sensors



Caution! Do not cover the venting holes.



Caution! If foaming occurs in the waste bottle, refer to “Foaming”.



Caution! Do not limit, change or remove the float position on the liquid level sensors (Figure 13).

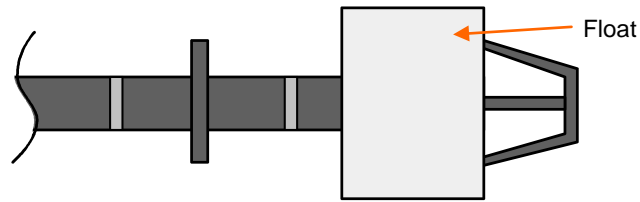

Figure 13. Correct position of the float on the buffer bottle sensor

Smaller bottles can also be used with an optional bottle holder (Cat. No. N10820).



Caution! If a smaller size buffer bottle is used with the bottle stand, the remaining volume in the bottle after the liquid level sensor indicates empty may be smaller than the nominal 290 ml.



Caution! Before disconnecting the tubings, prime the liquid system with air to avoid liquid spillage.

Connection diagram

Figure 14 shows the connections of the liquid level sensor cabling and liquid bottle tubing.

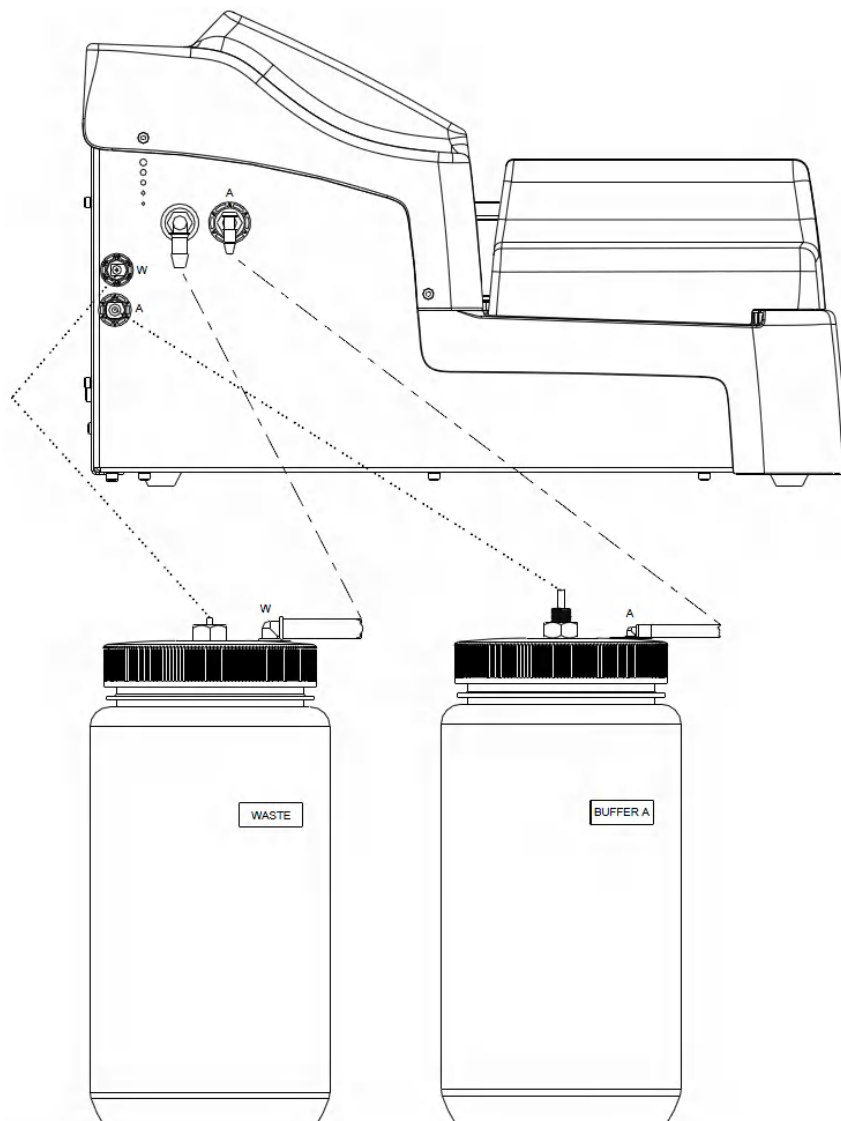

Figure 14. Wellwash connection diagram

Installing the liquid bottles

1. Fit the liquid bottle tubing to the corresponding color-coded tube connectors on the left side panel of the instrument (Figure 15). The connectors are from left to right: **W** = **colorless** (Waste) and **A** = **blue** (Buffer A).



Figure 15. Connecting the liquid bottle tubing

2. Connect the liquid sensor cables into the appropriate color-coded sockets on the left side panel of the instrument (Figure 16). The sockets are from top to bottom: **W** (Waste) and **A** (Buffer A).



Figure 16. Connecting the liquid sensor cable

All the liquid bottle tubings are connected to the instrument in Figure 17.



Figure 17. Liquid bottle tubings connected to the instrument



Warning! Make sure that the liquid level of the waste bottle is always kept below the maximum level indicated on the bottle to avoid potential overflow as the contents of the waste bottle is potentially infectious.



Warning! The contents of the waste bottle is potentially infectious, so it is important to wear protective clothing, such as disposable gloves, a laboratory coat and safety glasses, when emptying or handling the waste bottle.



Caution! Always ensure that the liquid bottles are attached properly. Always connect the bottle cap to the correct bottle and to the correct connector on the left side panel of the instrument. Otherwise the wash performance may be seriously affected.



Caution! Ensure that the intake tube reaches fully down to the bottom of the liquid bottle so that no red tubing is visible.



Caution! Check regularly that the liquid filter in the intake tube is clean. If not, replace or clean it.



Caution! To ensure proper function, do not disconnect the sensor cables from the instrument during operation.

Foaming

The liquid level sensor is unable to detect foam. In case of foaming:

1. Empty the waste bottle as soon as the foam level has reached the maximum filling level indicated on the waste bottle.
2. Add a commercially available anti-foaming agent, such as silicone oil, to the empty waste bottle to reduce foaming. Use concentrations of anti-foaming agents as recommended by the manufacturers.
3. Consider switching to a larger waste bottle and additionally increase the concentration of anti-foaming agent in the waste bottle.
4. Carefully swirl the waste bottle from time to time to improve mixing between the foam layer and anti-foaming agent.

Connecting the power supply cable



Warning! Do not operate the instrument from a power outlet that has no ground connection. Do not use a power supply cable other than the Thermo Scientific power supply cable designed for your region.

1. Ensure that the mains (I/O) switch (Figure 18) at the right-side panel of the instrument is in the off (0) position.
2. Connect the power supply cable to the power supply connector.
3. Connect the power supply to a correctly installed line power outlet with a grounded conductor.

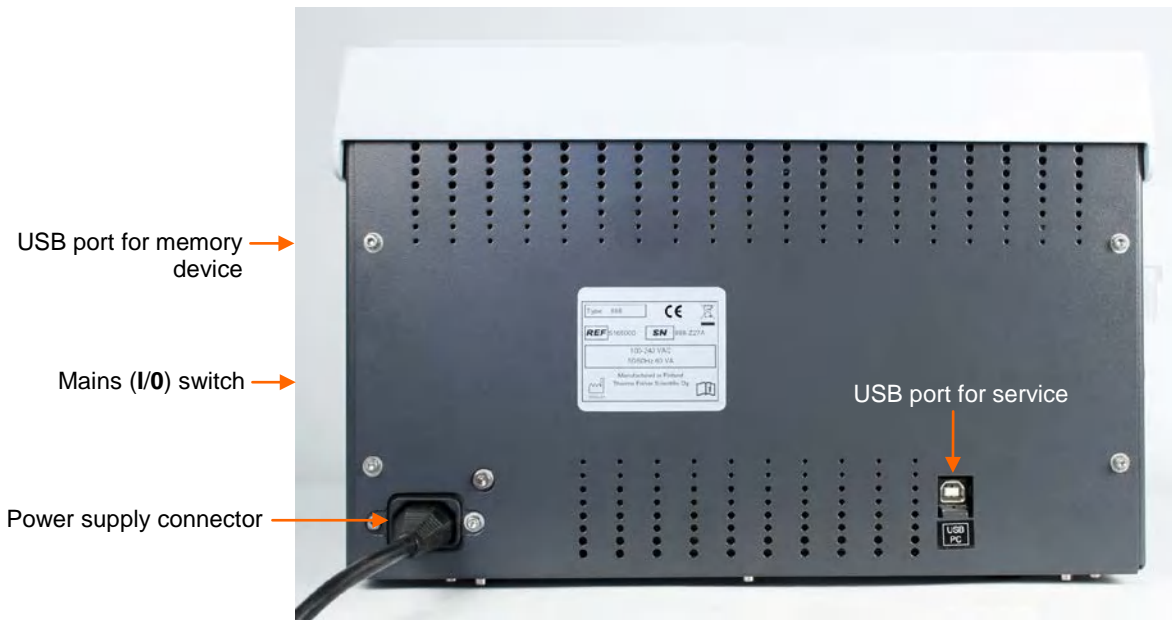

Figure 18. Connecting the power supply cable

USB port for PC

It is possible to connect the instrument to an external computer for service purposes (Figure 18).

Warnings and cautions

This instrument is designed to provide full user protection. When correctly installed, operated and maintained, it will present no hazard to the user.

The following recommendations are given for added user safety.

Electrical

Ensure that the power supply cable supplied with the unit is always used. If a correct type of mains cable is not provided, use only cables certified by the local authorities.

The power plug should only be inserted into a socket outlet with a protective ground contact. Never use an extension cable without a protective ground wire.



Warning! Only authorized technical service personnel are allowed to open the instrument.

The same precautions applicable when using any electrical equipment should naturally be observed with this instrument.



Warning! Do not touch switches or electrical outlets with wet hands. Switch the instrument off before disconnecting it from the mains supply.

Defects and abnormal stresses



Warning! If the instrument is not functioning properly, it may create electromagnetic perturbation, which could impair the operation of other devices or equipment in the usual laboratory environment.

Whenever it is likely that the protection system has been impaired, the instrument should be made inoperative and be secured against any unintended operation. Contact authorized technical service immediately.

The protection is likely to be impaired if, for example, the instrument:

- Shows any visible damage
- Fails to perform the intended functions
- Has been subjected to prolonged storage under unfavorable conditions
- Has been subjected to severe transport stresses.

Operating precautions and limitations before operation

1. Read this manual in its entirety, as it contains information necessary to ensure safe operation.
2. Always ensure that the electrical supply in the laboratory conforms to that specified on the type label at the rear of the instrument.
3. Ensure that the bottle and wash head tubings are properly fitted. Ensure that the intake tube reaches completely down to the bottom of the liquid bottle so that no red tubing is visible. Check regularly that the liquid filter in the intake tube is attached and clean.
4. Fill the buffer bottle only after an installation and operational check of the system.
5. Check that there is room in the waste bottle to run the protocol or series of protocols. Empty the waste bottle before a series of runs.

The liquid level sensor will warn if safe levels have been exceeded.



Caution! To ensure proper function, do not disable or disconnect sensors.

6. Check that a correct wash head is installed.
7. Check that the wash head configuration matches the configuration specified by the protocol. Calibrate the wash head if not yet calibrated.
8. Ensure that the priming vessel is empty and correctly installed.
9. Fit the microplate in the correct orientation appropriate for the wash head configuration. Note that if you do not load the microplate correctly onto the instrument, this will result in liquid spillage.



Caution! Mismatching the wash head and plate orientation may cause spillage.

10. Select the number of strips to be processed correctly. If there are strips missing on a plate, ensure that they are not selected for processing. If there are unused wells on the strip, it is recommended to fill unused wells with the same amount of deionized distilled water as in the used wells.

Mechanical checks before switching on

Before switching the instrument on:

- Move the wash head arm up and down, and the plate carrier back and forth to ensure that they move freely (Figure 19).
- Lift the wash head arm up and move the plate carrier under the wash head. Lower the wash head arm, with the wash head in place, so that the tips touch the plate carrier. Then move the plate carrier until the tips are aligned with the small circular indentations on the surface of the plate carrier. Check that the outermost tips in the wash head are directly above the indentations to ensure that the wash head arm is at right angle to the plate carrier.

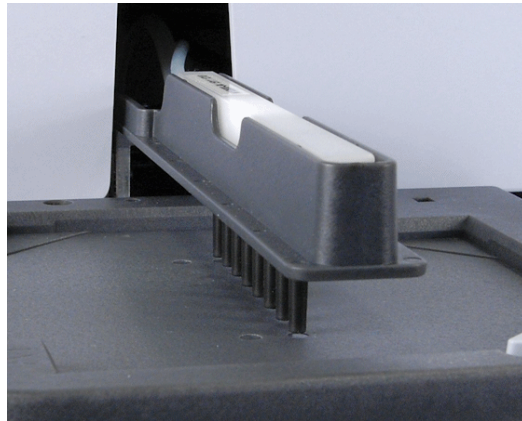

Figure 19. Alignment check

Installing the aerosol cover

The transparent aerosol cover may be present (Figure 20) or absent during operation. The aerosol cover primarily protects the user against biohazardous aerosols and the site against environmental contamination. Figure 20 shows the aerosol cover being installed. The corners have magnets for quick magnetic mounting of the cover.



Figure 20. Installing the aerosol cover

Switching on

Switch the instrument on. The system performs initialization tests (= self diagnostics) each time it is switched on.

To change the preferred user interface language or the local date/time, refer to “Settings menu”.



Caution! Do not switch the power off or plug/unplug the USB memory device during “Performing self diagnostics”.



Caution! Do not touch the wash head or plate carrier when the instrument is in use.



Note! Ensure that the wash head is installed.

Performing the operational check after switching on

Before putting the instrument into operation, perform the following operational check. For more information, refer to “Operating the instrument”.

- Ensure that the liquid bottles are empty.
- Turn the empty buffer bottle upside down to ensure that the liquid level sensor in the bottle works properly. The liquid level icon should be **green** when the buffer bottle is upside down and **red** when the buffer bottle is in an upright position. The liquid level icon should be **red** when the waste bottle is upside down and **green** when the waste bottle is in an upright position. For more information, refer to “Liquid level detection”.
- Fill the buffer bottle completely with liquid.
- Prime the instrument to ensure that priming works; the liquid tubing is filled with liquid and is aspirated to the waste bottle. Check for possible air leaks in the liquid system. Lift the buffer bottle about 20 cm and ensure that the wash head tips are not dripping. For more information, refer to “Priming the system”.
- Run a protocol, such as one of the demo protocols supplied with the instrument. The protocol should have an aspirate, dispense, shake, and soak function to ensure an adequate sample of functions to test the instrument’s proper operation. Check that the liquid channels and wash head tips work properly during dispensing and aspiration.



Warning! Clogged tips may cause faulty washing performance.

Settings after installation

To change the wash head type, the preferred user interface language or the date/time, refer to “Settings menu”.

Chapter 3: Wellwash Main Parts

Front view

The front view of the Wellwash instrument is shown in Figure 21.

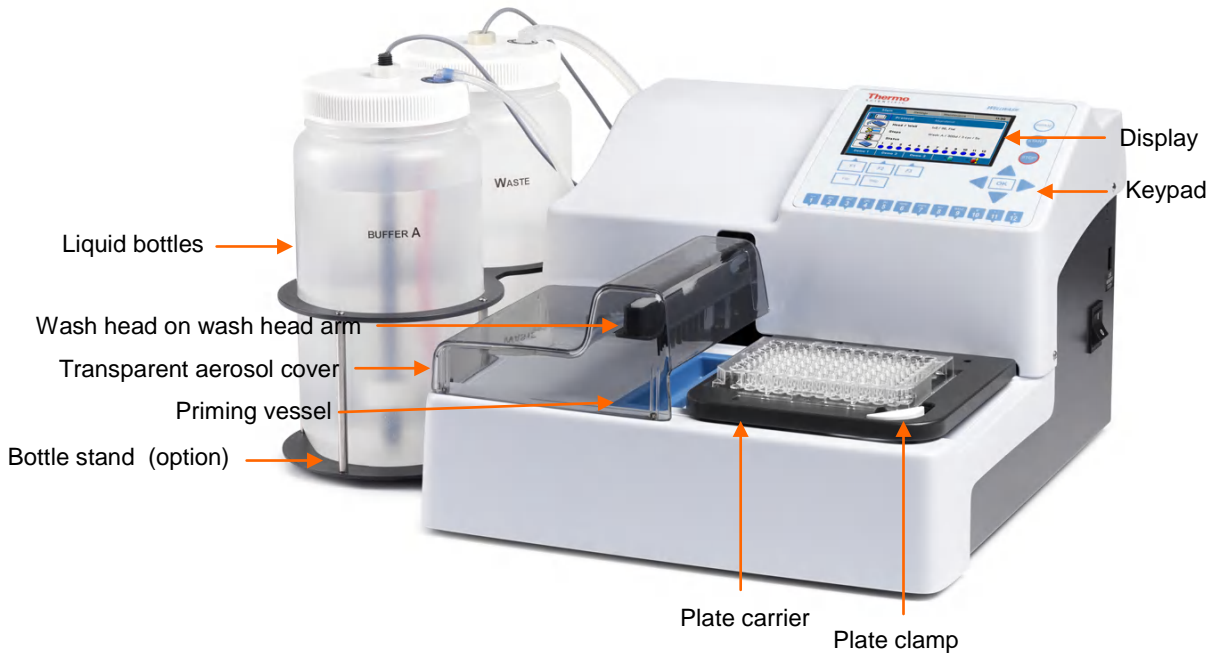

Figure 21. Wellwash front view with accessories

Back view

The back view of the Wellwash instrument is shown in Figure 22.



Figure 22. Wellwash back view

Side views

The side views of the Wellwash instrument are shown in Figure 23.

Connectors for liquid sensor cables,
from top to bottom:

W = colorless (Waste) and **A** = blue (Buffer A)

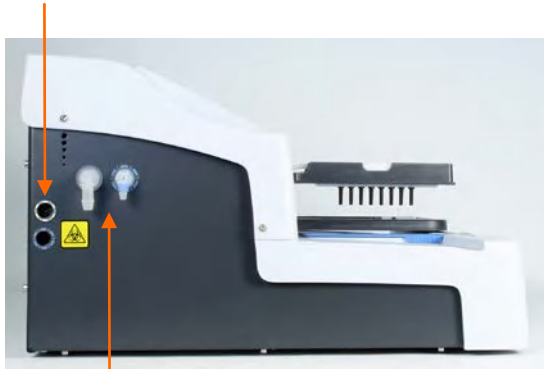

Connectors for liquid container tubes,
from left to right:

W = colorless (Waste) and **A** = blue (Buffer A)

Left Right

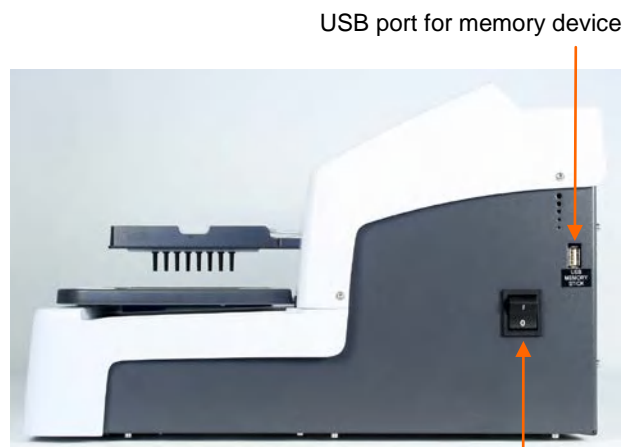

USB port for memory device

ON/OFF (I/O) switch

Figure 23. Wellwash side views

Liquid system diagram

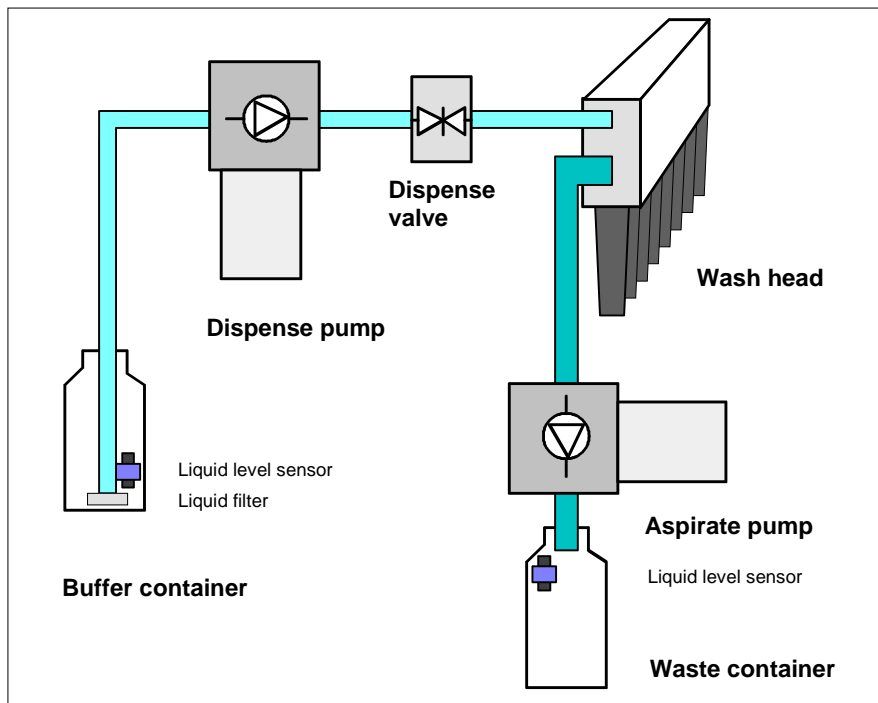

Figure 24. Liquid system diagram

USB memory device port

The instrument is equipped with a USB port for an external memory device (Figure 23). You can transfer wash protocols from one instrument to another of the same model with the USB memory device.



Note! It is recommended to format the USB memory device if export or import fails. For more information, refer to Chapter 13: “Troubleshooting Guide”.

You can check the functionality of the USB memory device by inserting it into the USB port for memory device (Figure 23). The “WELLWASH” folder will be created.

USB PC port

The instrument is equipped with a USB port for an external PC connection for service use (Figure 22).

Plate carrier

The plate carrier supports both portrait and landscape orientation of the 96-well plate (Figure 21). A plate clamp is incorporated in the plate carrier to keep the plate in place during processing. A sensor in the plate clamp senses the presence of a microplate.

Wash heads

The wash head alternatives (Figure 25) are shown below.

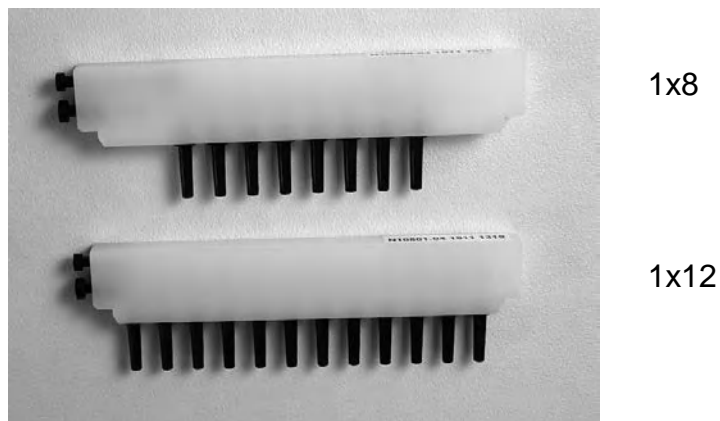

Figure 25. Wellwash 1x8 and 1x12 wash heads



Warning! Do not remove the wash head plugs when in use.



Caution! Only use wash heads that have an identification label.

Shaker

The linear shaker operates at three different speeds (Table 1).

Table 1. Shaking speeds

Speed designation	Speed
Low	5 Hz, amplitude 2.5 mm
Medium	10 Hz, amplitude 1.5 mm
High	15 Hz, amplitude 1 mm



Caution! The instrument is not intended for shaking purposes only. A separate microplate shaker is available if needed (e.g. Thermo Scientific™ iEMS™ Incubator/Shaker). Refer to www.thermoscientific.com.

Chapter 4: Operating the Instrument

Display and keys for navigating and editing

The keypad and display are shown in Figure 26.

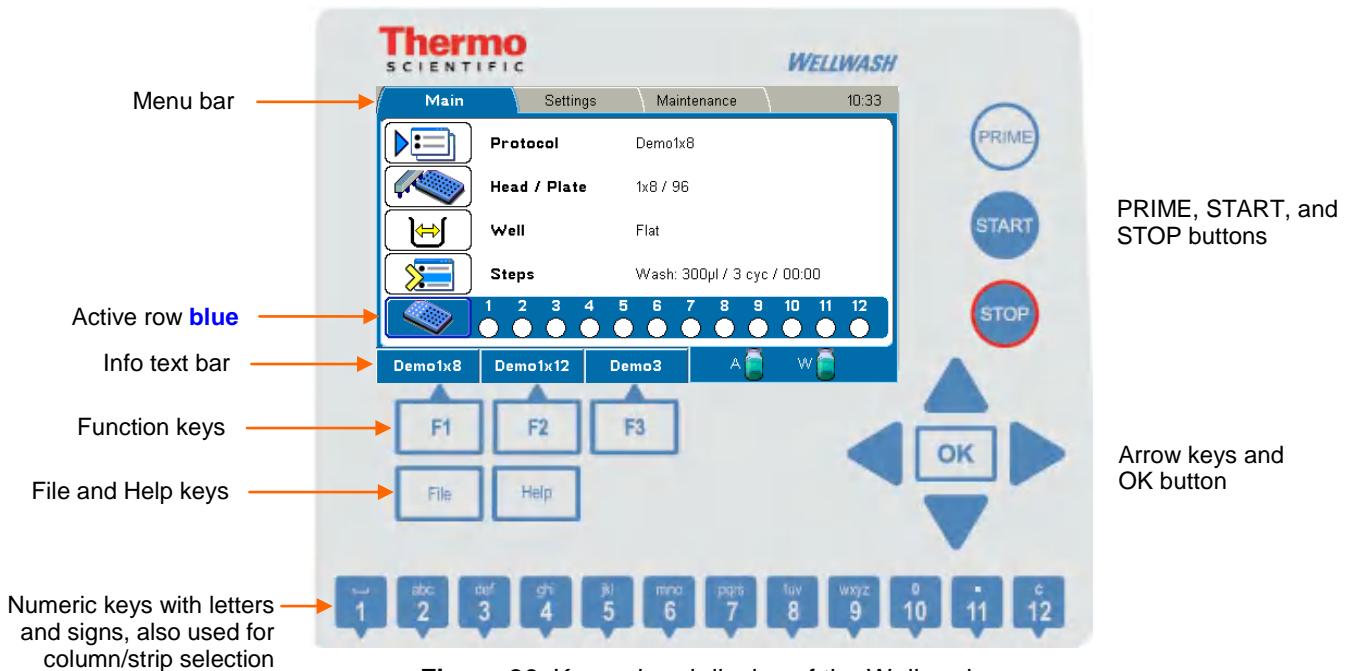

Figure 26. Keypad and display of the Wellwash

The keys for navigating and editing are detailed below. The keys also have other functions depending on the level in the software.

The active row is colored **blue**.



Use the **Left, Right, Up** and **Down** arrow keys to navigate. You can speed up selection by holding down the arrow key.

Press the **OK** button to select, edit, or accept the highlighted item.



Use the **F1-F3** keys to select the corresponding action from the info text bar (Figure 26). The information on the info text bar is updated according to the active menu. In the **Main** menu, the **F1-F3** function keys are reserved for protocols that you can assign to the keys for quick selection. The instrument is shipped with three demo protocols assigned to the keys. To assign your own protocols to the keys, press the **FILE** key in the protocol list view and select *Quick Key*.

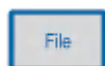

Press the **FILE** key, for example, to save the active protocol in the **Main** menu. Depending on the active menu, the **FILE** key opens a list of actions possible for the current protocol: **New, Open, Save, Save As, Quick Key, Export, Import** and **Delete**.

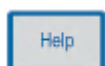

Use the **HELP** key for more detailed instructions.



Press the **PRIME** button to prime the instrument.



Press the **START** button to start the execution of the currently selected protocol.



Press the **STOP** button to terminate protocol execution.

Pressing the key also returns the software to the previous state.



Use the character keys to enter numerical data and text.

- The space character is found under the **1** key.
- The following special characters are found under the **. / 11** key:
. - _ ' + ! ? % : ()
- The **µ** character is found under the **mno / 6** key.

The **CLEAR (C / 12)** key is used to delete written text or numbers.

Use the keys to select strips. Refer to “Strip selection with the number keys”.

To write an uppercase letter, press the desired letter key repeatedly until the capital appears.

Menus

The software includes the **Main**, **Settings**, and **Maintenance** menus.

The menu tree is displayed in Table 2.

Table 2. Program overview

Main	Settings	Maintenance
└ Protocol	└ Prime parameters	└ Clean
└ Head / Plate	└ Sensors	└ Calibration
└ Well	└ Wash head configuration	└ Service
└ Steps	└ System	
└ Layout	└ Reports	

Main menu

You can specify the protocol-related parameters and manage the run of the active protocol in the **Main** menu.

The **Main** menu contains the **Protocol**, **Head / Plate**, **Well**, **Steps**, and **Layout** rows, and their parameters.

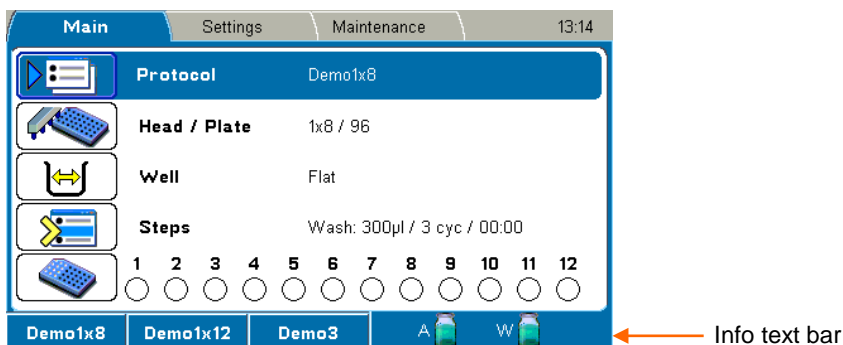

The clock on the menu bar shows the local time.



Note that the **blue** clock icon appears on the menu bar when **Autoprime** is active.

- * An asterisk in front of a protocol name means that the protocol has not yet been saved.

- ⚠ A yellow caution symbol on the **Head / Plate** row means that the current protocol has a different wash head than the one defined in the **Settings** menu. Refer to “Wash head configuration”.



See the info text bar for the required actions of the **F1-F3** keys. The action text on the info text bar changes according to the current menu.

Liquid level detection

The info text bar also shows the liquid level in the bottles (**A** and **W**). The liquid bottles have sensors to enable liquid level detection. Fill the buffer bottle and empty the waste bottle if the red bottle icon appears on the info text bar. Refer to “Sensors”.



Liquid level detection (LLD):

Liquid A

- icon is **green** when the bottle is filled with liquid
- icon is **red** with an exclamation mark when the bottle is nearly empty or disconnected (The warning is activated when there is approximately 290 ml in the 2 liter wash bottle / 580 ml in the 4 liter wash bottle.)
- icon is **empty** with a cross when the LLD is disabled

Waste

- icon is **red** with an exclamation mark when the bottle is full or disconnected
- icon is **green** when the bottle is not yet full
- icon is **empty** with a cross when the LLD is disabled

Chapter 5: Running Protocols

General operating procedure for running a protocol

1. Ensure that the buffer solution in the buffer bottle A is correct and that there is sufficient liquid for the protocol. Also ensure that the waste bottle is not full when you begin. Ensure that the liquid level sensors are enabled and symbols are green. Refer to “Liquid level detection”. Ensure that the tubing is properly fitted.

The liquid levels in the bottles are monitored during runs. Follow the color-coded icons on the info text bar. Refer to “Filling and emptying liquid bottles”.

Ensure that the intake tube is fixed to the lowest position on the cap, whereby no red tubing is visible above the cap, and fully immersed in the buffer bottle.

2. Select a protocol. Refer to “Selecting a protocol”.

The selected protocol name is shown on the **Protocol** row in the **Main** menu.

3. Ensure that the protocol parameters are correct.

4. Insert the 96-well plate to be washed onto the plate carrier and ensure that the microplate is correctly oriented according to the wash head configuration.

The A1 position of the plate is in the upper left corner when the 1x8 wash head is in use and in the lower left corner for the 1x12 wash head. Refer to “Loading the plate”.

If you are using strip plates, ensure that the individual strips are properly attached to the plate frame.

Ensure that the plate is not covered.

5. Press the **PRIME** button to prime the instrument. Refer to “Priming the system”.



6. Select the strips if they are not already selected. Refer to “Strip selection”.



7. Press the **START** button.



8. The microplate is processed according to the predefined protocol.

9. Check that the liquid channels work properly during dispensing and aspiration.

10. If you need to abort the run, press the **STOP** button.

11. Remove the plate after the protocol has ended.

12. Prime the instrument with distilled deionized water at the end of the batch.



Note! If you use a partial strip plate, make sure that your column/strip selection matches the physical strips on the plate.



Note! Do not remove the plate before the end of the protocol run.



Note! It is recommended to shut down the Wellwash at the end of the day. Refer to “Shutting down”.

Filling and emptying liquid bottles



Warning! Biohazard risk.



Caution! Before disconnecting the tubings, prime the liquid system with air to avoid liquid spillage.

1. Disconnect the liquid bottles and fill or empty them when necessary. Refer to “Liquid level detection”.
2. Unscrew the liquid bottle cap and fill with a suitable buffer solution.
3. Replace the liquid bottle cap and reinstall the bottles. Refer to “Liquid bottles”.
4. Always reprime the system before running a protocol. Refer to “Priming the system”.

Starting ready-made protocols

You can select a protocol using the quick keys or from the protocol list and start it.

Starting a ready-made protocol with the quick keys (F1-F3)

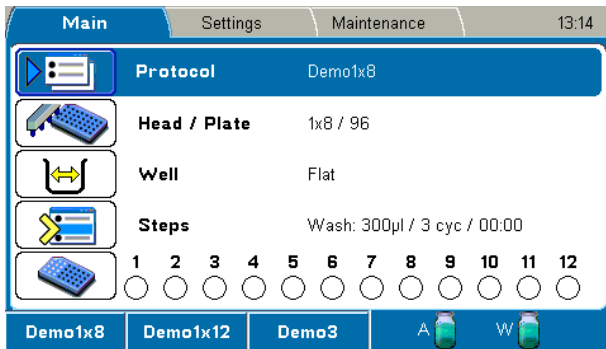

F1-F3 function keys



Use the **F1-F3** function keys reserved for ready-made, demo or favorite protocols. Three default protocols may be connected to the **F1-F3** keys. You may change these protocols from Protocol > OK > FILE > Quick Key > **Set/Clear F1-F3**.

Starting a ready-made protocol from the list

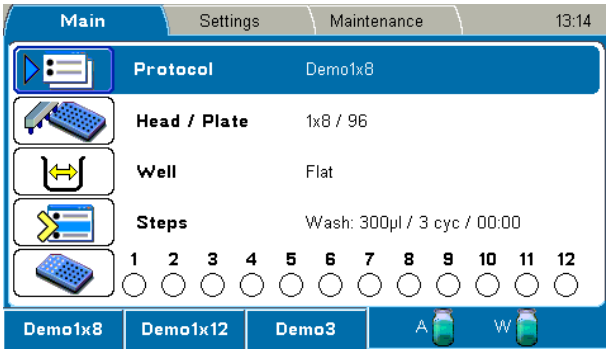

1. Press the **OK** button on the **Protocol** row in the **Main** menu.

OR



Press the **FILE** key in the **Main** menu and select *Open* using the **Down** arrow key, and then press the **OK** button.

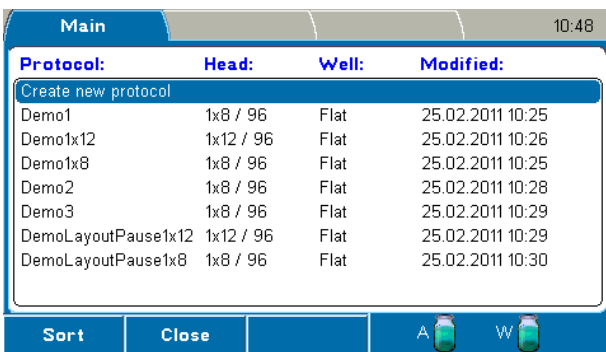

Example protocol list



2. Select the ready-made protocol from the protocol list and press the **OK** button.

Loading the plate

The wash head defines the plate type and orientation (Table 3, Figure 27 and Figure 28).

Table 3. Wash head type and plate orientation

Wash head	Plate	Orientation
1x8	96-well plate	Landscape
1x12	96-well plate	Portrait



Figure 27. 1x8 orientation



Figure 28. 1x12 orientation



Caution! Ensure that the microplate is correctly oriented to match the wash head (Table 3).



Caution! Ensure that the strips on a strip plate are pressed flat on the frame. Misaligned strips may increase the residual volume or limit plate carrier movement.



Caution! Ensure that the plate is not covered.



Caution! Do not limit the plate clamp operation.

Insert the 96-well plate onto the plate carrier (Figure 29). Position A1 of the plate should correspond to position A1 marked on the plate carrier.

Ensure that the plate is firmly placed flat on the plate carrier. The plate clamp will hold the plate in position during the run.



Figure 29. Inserting the microplate in landscape mode



Caution! Ensure that the strips in strip plates are positioned in the microplate as selected in the user interface, otherwise spilling may occur and the instrument may become contaminated.



Caution! For proper performance, all the wells in a strip should have an equal amount of liquid. It is recommended to use distilled deionized water in unused wells on the strip.

Priming the system



Press the **PRIME** button to fill the liquid tubing completely from the buffer bottle intake tube to the wash head tips. If you prime for the first time, fill the buffer bottle completely to ensure proper priming. The default priming volume is 30 ml in order to fill the liquid tubing properly. The dead volume of the liquid tubing is 19 ml (Figure 30).

The default volume used during priming is defined in the Settings > Prime parameters > **Prime volume (Prime button) (ml)** menu. Refer to “Prime parameters”.

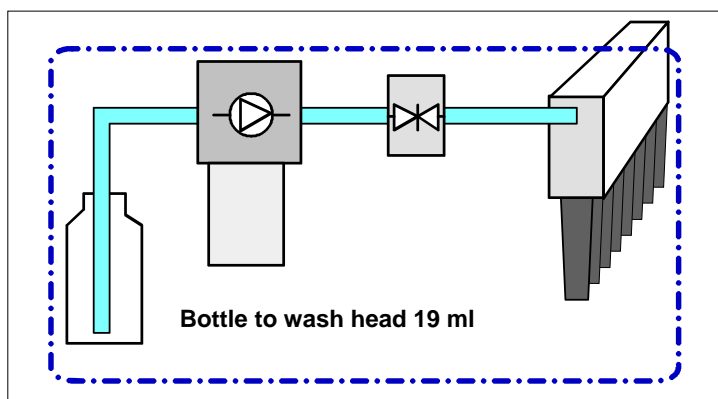

Figure 30. Dead volume of the liquid tubing



Caution! Prime the liquid system with the liquid to be used (wash buffer). Ensure that the dispensing pump is not run for longer than a few minutes without liquid, otherwise it may be damaged. Check for possible air leaks.



Note! If the instrument has not been used for a longer period, you might need to perform the Boost prime option. Refer to “Service”.

Strip selection



1. To select the columns/strips of the plate, use the number keys.

OR



2. Press the **OK** button in the **Layout** row in the **Main** menu.

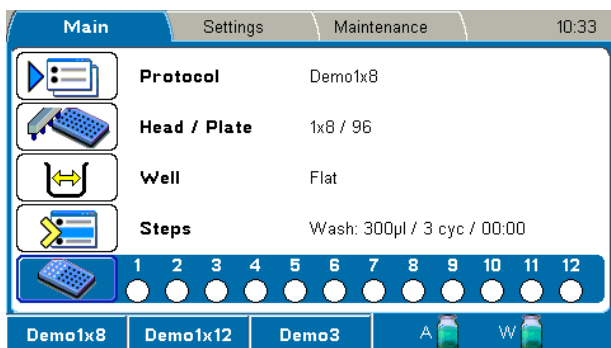

Strip selection with the number keys



It is possible to select the strips with the number keys regardless of which row is highlighted in the **Main** menu.

The following rules apply when selecting the columns/strips:

- 1x8 wash head: Press the keys 1–12, any combination
- 1x12 wash head: Press the keys 1–8, any combination
- All columns/strips: Double-press the 8 or 12 key to select all columns/strips when the selection is empty.
- Select or unselect a column/strip: Press the corresponding number key.
- Range of strips: First select the starting strip and then double-press the key corresponding to the final strip in the range.
- Deselect a range of strips: Double-press a key to delete all selected strips in descending order.
- Clear all selections: Hold the **C / 12** key down for more than 2 seconds.



Note! Strip selection is disabled if the Layout step is the first step of the protocol. Refer to “Layout”.

Strip selection with the Layout row

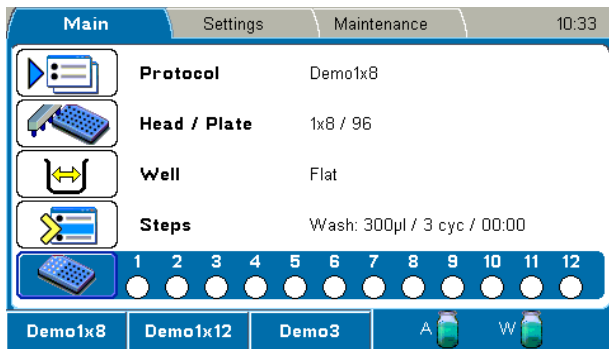

Go to the **Layout** row in the **Main** menu and press the **OK** button.

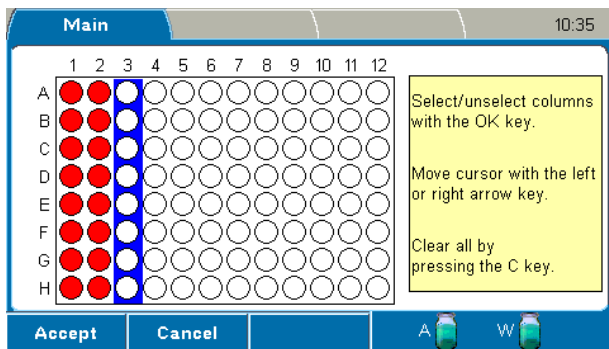

Select/unselect columns/strips with the **OK** button and move the cursor using the **Left** or **Right** arrow key.

All selections are cleared with the **C** key.

Columns/strips 1–12 are edited if a 1x8 wash head is used or columns/strips 1–8 for a 1x12 wash head.

The selected columns/strips are highlighted with **red** color.

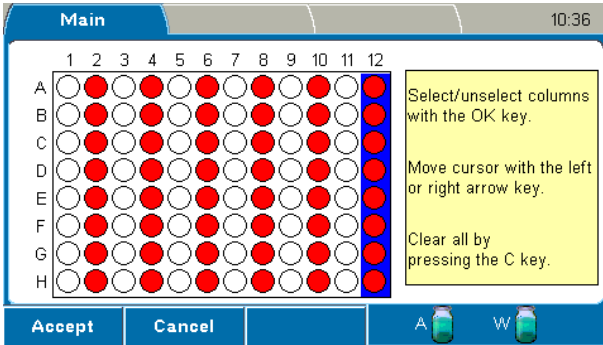

Starting a run

1. Press the **START** button to start the run.



The microplate will be processed according to the protocol.



Note! Ensure that the liquid channels work properly during dispensing and aspiration.

2. Remove the plate after the protocol has ended.



Note! Prime the instrument with distilled deionized water at the end of the batch.

Canceling a run

- Press the **STOP** button to cancel a run.



Note! It is not possible to stop the run when a user input is required as a response to a warning or error message.

Chapter 6: Menus, Tabs and Parameters

Menus

The software includes the **Main**, **Settings**, and **Maintenance** menus/tabs.

The menu tree is displayed in Table 4.

Table 4. Program overview

Main	Settings	Maintenance
└ Protocol	└ Prime parameters	└ Clean
└ Head / Plate	└ Sensors	└ Calibration
└ Well	└ Wash head configuration	└ Service
└ Steps	└ System	
└ Layout	└ Reports	

Main menu/tab

You can specify the protocol-related parameters and manage the run of the active protocol in the **Main** menu.

The **Main** menu contains the **Protocol**, **Head / Plate**, **Well**, **Steps**, and **Layout** rows, and their parameters.

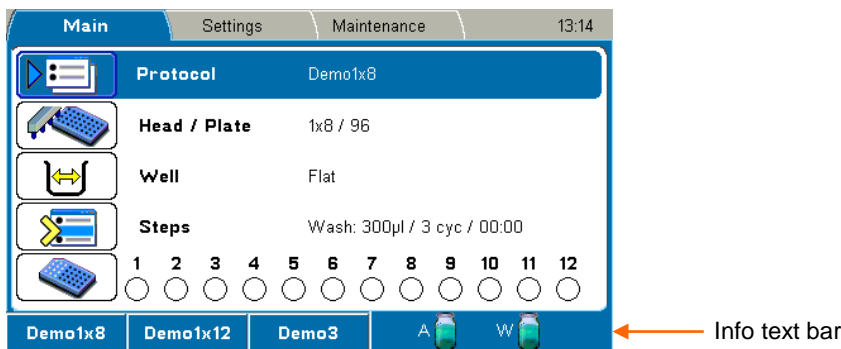

The clock on the menu bar shows the local time.



Note that the **blue** clock icon appears on the menu bar when **Autoprime** is active.

- * An asterisk in front of a protocol name means that the protocol has not yet been saved.

-  A yellow caution symbol on the **Head / Plate** row means that the current protocol has a different wash head than the one defined in the **Settings** menu. Refer to “Wash head configuration”.



See the info text bar for the required actions of the **F1-F3** keys. The action text on the info text bar changes according to the current menu.

Protocol

The **Protocol** row in the **Main** menu shows the name of the active protocol.

You can open another protocol by pressing the **OK** button on the **Protocol** row or by pressing the **FILE** key. The list of protocols saved in the software will appear. The protocols are listed in alphabetical order by protocol name. At least 100 wash protocols can be saved to memory.

Protocol:	Head:	Well:	Modified:
Create new protocol			
• Demo1	1x8 / 96	Flat	25.02.2011 10:25
Demo1x12	1x12 / 96	Flat	25.02.2011 10:26
Demo1x8	1x8 / 96	Flat	25.02.2011 10:25
• Demo2	1x8 / 96	Flat	25.02.2011 10:28
• Demo3	1x8 / 96	Flat	25.02.2011 10:29
DemoLayoutPause1x12	1x12 / 96	Flat	25.02.2011 10:29
DemoLayoutPause1x8	1x8 / 96	Flat	25.02.2011 10:30



It is possible to protect protocols from accidental editing or deleting. A locked symbol is shown in front of the protocol name when locked.

To lock/unlock a protocol, select it on the protocol list and press the **F3** key.

For instructions on how to start protocols, refer to Chapter 5: “Running Protocols”.

Creating a protocol



1. Press the **FILE** key in the **Main** menu to create a new protocol. Refer to “Protocol”.



2. Select *New* and press the **OK** button.

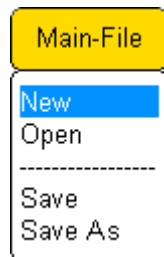

3. Select the **Head / Plate** row. The default wash head shown is according to **Wash head configuration**. Refer to “Head / Plate”.



4. Select the wash head.

If the selected wash head is different from the one that is set in the **Settings** menu, you must change the wash head in the **Settings** menu before starting the protocol. Refer to “Wash head configuration”.



Caution! If you edit an existing protocol and change the wash head, the wash head related step parameters of the protocol (e.g. the Wash step) are automatically reset to default values. Soak and Pause steps are not affected.

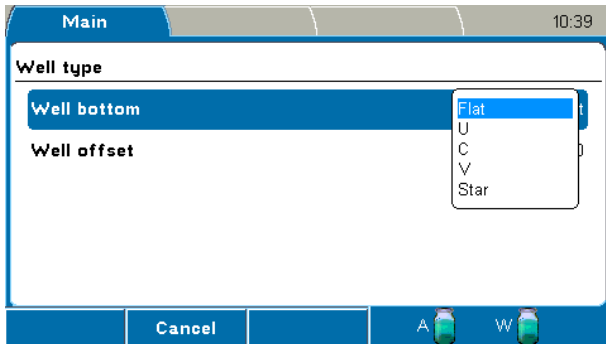

5. Select **Well**. The **Well type** window opens. Refer to “Well”.



6. Select the well bottom shape of the plate or strips.



7. Select **Well offset** to adjust the well offset value. For more information on the Preview function, refer to “Well”.



Note! Well offset has an effect on the residual volume.



8. Select the **Steps** row in the **Main** menu. Refer to “Steps”.

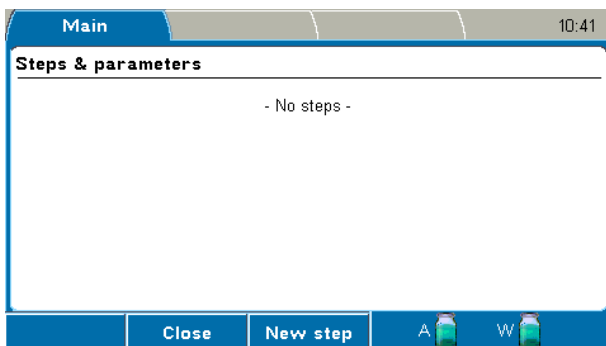

9. Press the **F3** (New step) key to open the step list box.

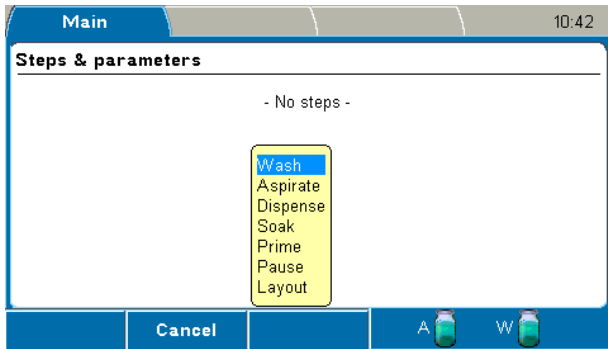

10. Select the step.

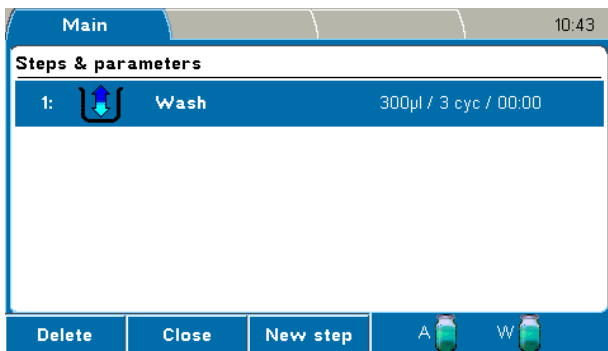

Steps are listed and numbered in order of execution. It is possible to create several steps in the step list and process the steps in the defined sequence.

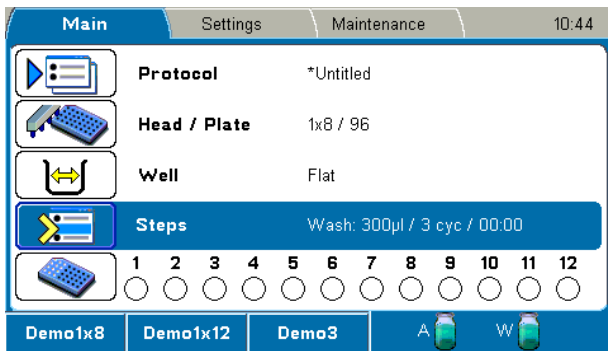

Refer to “Adding new steps to protocols” and “Deleting steps from protocols”.

For more information on the step parameters, refer to “Steps”.



11. Press the **FILE** key in the **Main** menu. Note that the strip selection is not saved with the protocol. Use the Layout step if you want to save the strip selection.



12. Select *Save As*. The *Save Protocol As* dialog opens.



13. Enter the protocol name, for example, *Test1*, by using the character keys. The protocol is now created.



Note! You cannot use the protocol name “Untitled”.

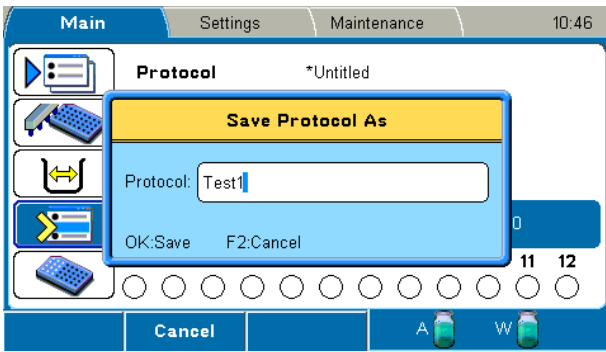

Note! You cannot save a protocol with a name already in use.

Creating a protocol in an optional way

You can also create a protocol using the **Protocol** window:



1. Select the **Protocol** row in the **Main** menu and press the **OK** button.
2. Select the **Create a new protocol** row and press the **OK** button.

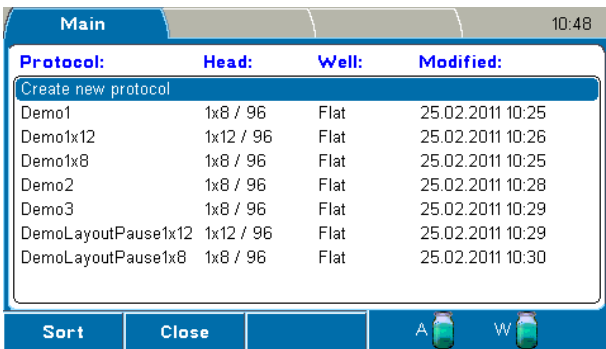

3. Enter a name for the protocol and press the **OK** button.

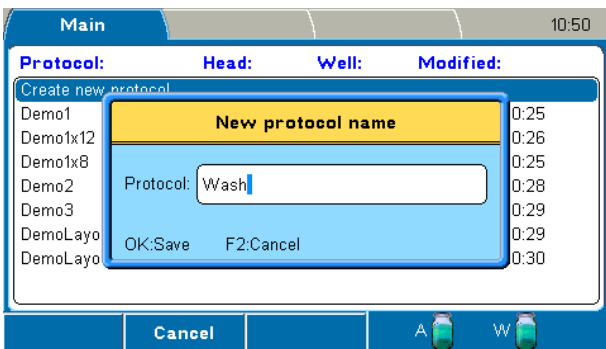

- In the **Main** menu, set the desired protocol parameters and steps.
- When ready, press the **FILE** key and select **Save** to save your protocol.

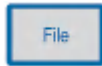

Adding new steps to protocols

- Select the **Steps** row in the **Main** menu and press the **OK** button.

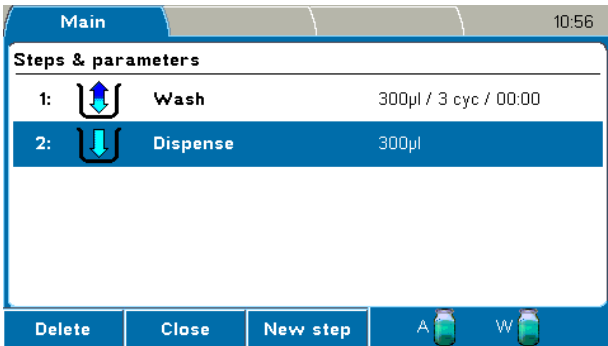

- Press the **F3** (New step) key to open the step list box.

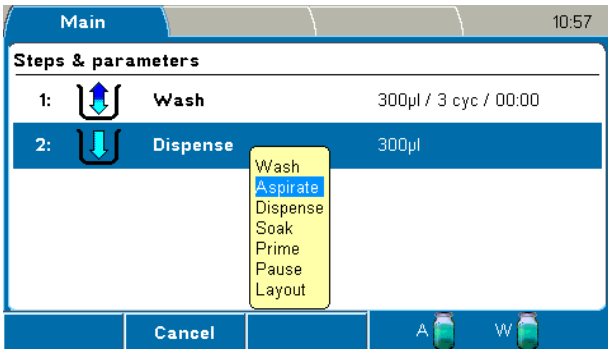

- Select the new step and press the **OK** button.



- A flashing insert bar with the selected step appears. Select the position where you want to insert the step by using the **Up** or **Down** arrow key and then press the **F3** (Insert) key.

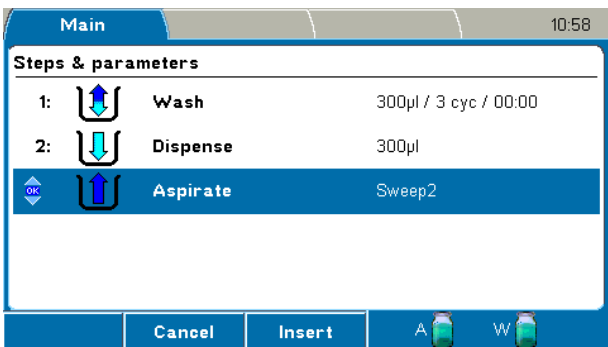



5. Press the **OK** button to edit the new step. For more information on steps, refer to “Steps”.
6. Save the changes you make in each step using the *File – Save* functions.
7. Press the **F3** (New step) key to add further new steps to the protocol.



When there are more than five steps, **blue** arrows appear at the bottom and/or at the top of the display.



8. Use the **Up** and **Down** arrow keys to navigate in the protocol.

Deleting steps from protocols

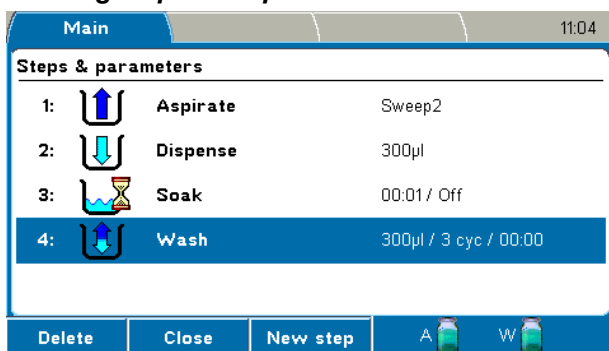

1. Select the step you want to delete and press the **F1** (Delete) key.

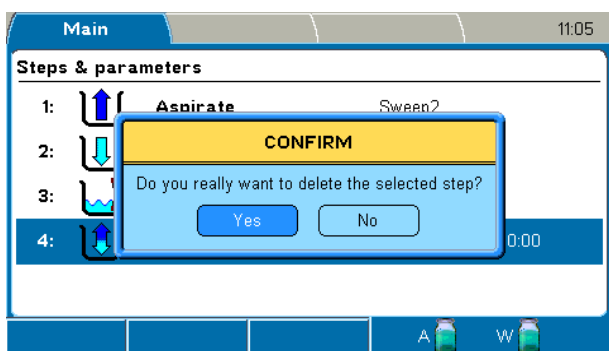

2. Press the **OK** button to confirm the deletion.

Head / Plate

You can select the wash head and plate format on the **Head / Plate** row in the **Main** menu.



Caution! If you edit an existing protocol and change the wash head, the wash head related step parameters of the protocol (e.g. the Wash step) are automatically reset to default values. Soak and Pause steps are not affected.

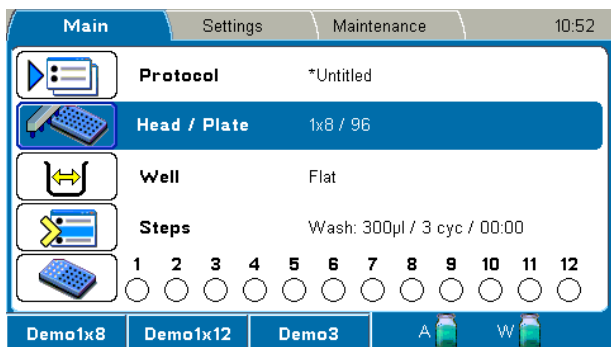

When you press the **OK** button, the wash head/plate list box appears.

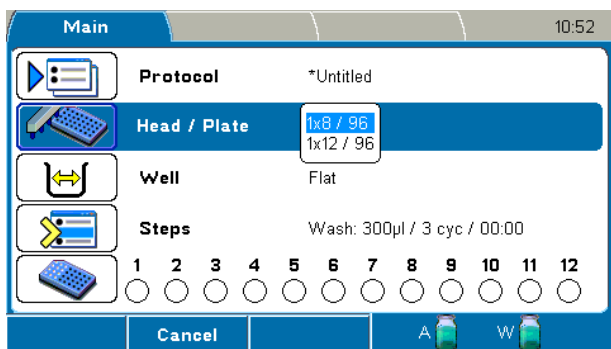

Select the wash head and press the **OK** button. Refer to “Wash head configuration” and “Creating a protocol”.



Note! Calibrate the wash head if it is not already calibrated.

Well

You can select the well shape and well offset on the **Well** row in the **Main** menu.



Caution! If you edit an existing protocol and change the wash head, the wash head related step parameters of the protocol (e.g. the Wash step) are automatically reset to default values. Soak and Pause steps are not affected.

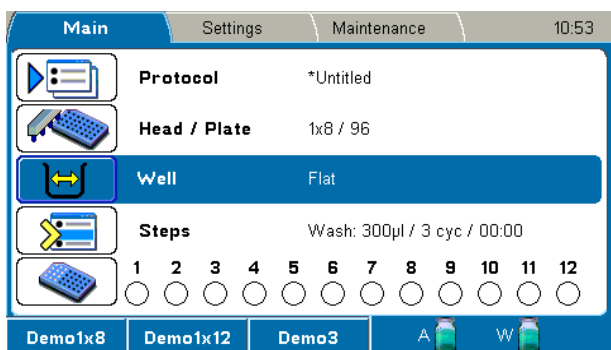



When you press the **OK** button, the **Well type** window appears.

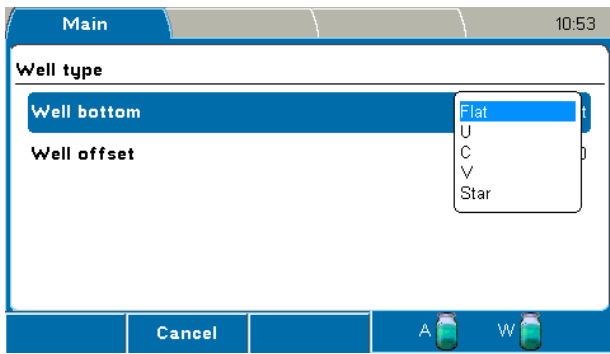

The following settings are available:

- **Well bottom** – Select the well shape.

Different well shapes of strips and plates available are shown in Figure 31. The default well shape format is *Flat*.



Note! The well shape has an effect on the aspirate height and the aspirate mode.



Flat
Flat
bottom

C
Flat bottom
with curved
edges

U
Round
bottom

V
V bottom

Star A
Flat bottom
with curved
edges and 8 ribs

Star B
Showing the
orientation of
the 8 ribs

Figure 31. Well shapes

- **Well offset** – Adjust the X offset of a plate. The offset value ranges from -1.5 mm to 1.5 mm in increments of 0.1 mm.



Use the **Up** and **Down** arrow keys to adjust the value.



Press the **F3** (Preview) key to move the plate carrier and align the wash head over the first column of a plate. Then press the **Up** or **Down** arrow key to move the plate carrier in steps of 0.1 mm.



Warning! Well offset has an effect on the residual volume in the well. With U- and V-shaped wells, setting the well offset off center will increase the residual volume.



Note! With Flat bottom wells, setting the well offset off center may decrease the residual volume. This feature should only be used with the Normal aspirate mode.



Press the **OK** button to accept the value and/or the **F2** key to close the window.

Microplate requirements

96-well format microplates meeting the ANSI/SBS standard can be used with the Wellwash (Table 5).



Note! Use only plates manufactured according to ANSI/SBS standard dimensions.

Table 5. Default values used for different bottom shapes

Bottom shape	Default bottom height	Thermo Scientific™ Reference plate code	Max. overall plate height
Flat	3.1 mm	439454 Nunc™ solid F96	14.5 mm ± 0.2 mm
U	4.2 mm	449824 Nunc U96	14.5 mm ± 0.1 mm
C	3.4 mm	430341 Nunc C96	14.0 mm ± 0.3 mm
V	4.2 mm	249662 Nunc V96	14.5 mm ± 0.1 mm
Star	3.6 mm	441653 Nunc starwell strip plate	14.5 mm ± 0.1 mm

Steps

You can create or edit the wash protocol in the **Main** menu. It is recommended to test the optimal parameters for each assay before operation.

Steps are listed and numbered in order of execution. It is possible to add several steps to the step list. The maximum number of steps in a protocol is 99.

If there is more than one step in the protocol, the step parameters are not shown on the **Steps** row.

The following steps are available:

- Wash
- Aspirate
- Dispense
- Soak
- Prime
- Pause
- Layout

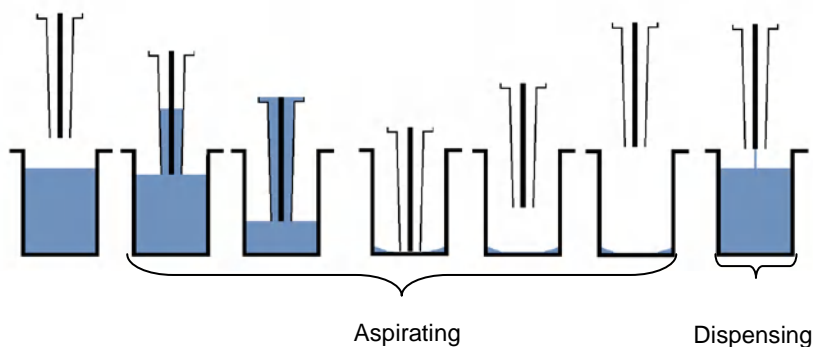

Figure 32. Principle of Wash step (Normal)

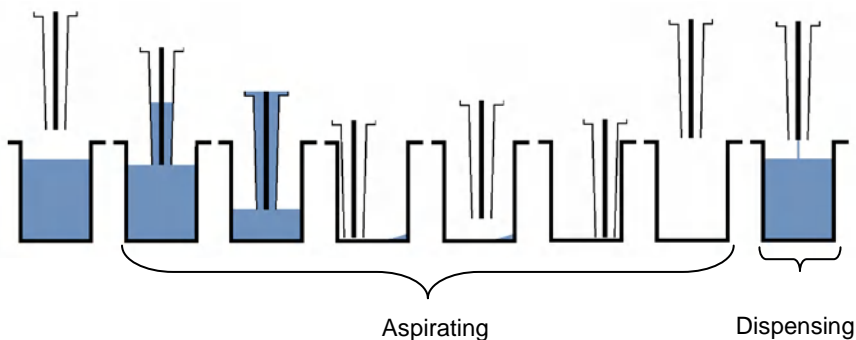

Figure 33. Principle of Wash step (Sweep2)

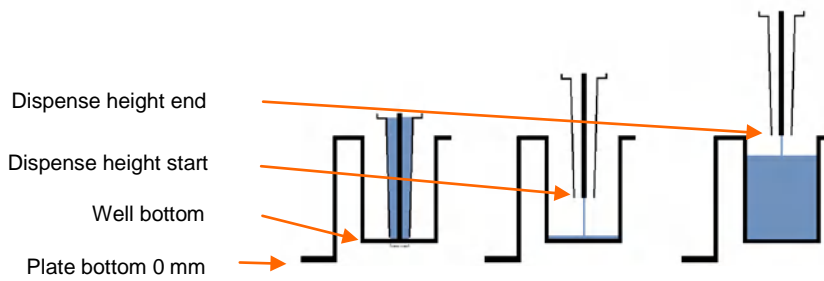

Figure 34. Dispense heights

- **Preview** – Use the Preview function to adjust the height positions in the Wash, Aspirate and Dispense steps.

Select the height parameter and press the **OK** button to activate the height editing and Preview function.



Press the **F3** (Preview) key to move the plate carrier and align the wash head over the first column of a plate. Then press the **Up** or **Down** arrow key to move the wash head in steps of 0.1 mm. Press the **OK** button to confirm the height.

Wash



The wash step is the only step needed in most wash protocols. The well is first emptied, then filled with buffer and finally emptied or left full.

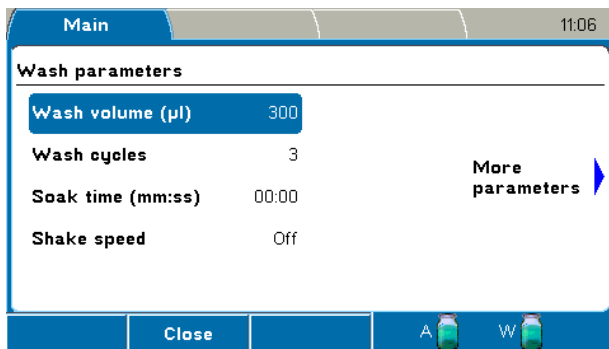

The wash parameters are grouped into two windows. Use the **Right** and **Left** arrow keys to move from one window to another.

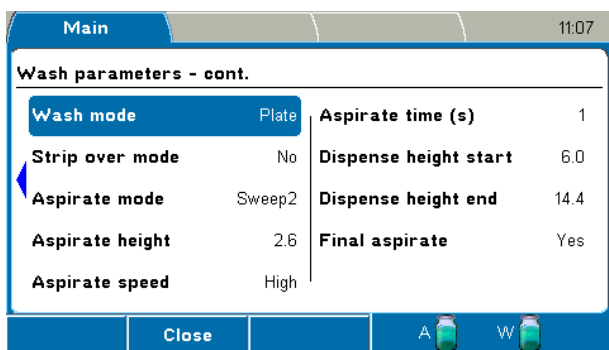

The *Wash* step has the following parameters:

- **Wash volume (µl)** – Define the volume of the wash buffer used in microplate washing. The range is 50 µl to 1000 µl in 10 µl increments. The default value is 300 µl.



Note! It is possible to dispense more than the well volume and the excess liquid is aspirated, as the aspiration is always on. If a so-called overflow volume is selected where the dispensing volume is greater than the well volume, pay attention to the dispense end height. Check that the wash head tips are inside the well.

- **Wash cycles** – Define the number of wash cycles that will be performed, from 1 to 10. The default value is 3.
- **Soak time (mm:ss)** – Define the time period between wash cycles in the wash step. The default value is 00:00 (= no soak). The minimum value is 0 s and the maximum value 60 min in increments of 1 s.
- **Shake speed** – Define the shake speed Off, Low, Medium, or High. The default is *Off*. The shake speed setting is only effective when the soak time is > 00:00.



Caution! Ensure that the liquid does not spill at the shake speed and volume settings in use.

- **Wash mode** – Define the wash mode. The default is *Plate* mode.
 - **Plate** – All selected strips are processed before the next cycle.
 - **Strip** – Each selected strip is processed the number of cycles before moving to the next strip.
- **Strip over mode** – Define the strip over function. The default is *No*.
 - **No** – All selected strips are processed as fast as possible.
 - **Yes** – Unused strips are processed dry. The time parameters are measured during the first protocol run. The wash head stays above unused strips for as long as it takes to process each selected strip. This selection is recommended when the timing for washing strips is critical. You can maintain the time between cycles constant with this option. It is recommended to carry out a dummy run before the actual samples. Refer to Figure 32.
- **Aspirate mode** – Define the aspirate mode Normal, Sweep 2, or Sweep 3. Sweep is allowed for 96-well plates with flat wells. The default depends on the wash head type or well shape. Refer to Figure 33.
 - **Normal** – There is one aspirate position in the center of the well.
 - **Sweep2** – Aspirate in two different positions across the bottom of the well.
 - **Sweep3** – Aspirate in three different positions across the bottom of the well.
- **Aspirate height** – The aspirate height ranges from 0 mm to 14 mm in 0.1 mm increments. The default height varies according to the plate type and well shape (Table 6). The zero height from which the aspirate height is defined is the lowest level of a plate when the plate is properly placed on the plate carrier. Refer to Figure 34.



Caution! Too high an aspirate height increases the residual volume.



Note! The aspirate height determines the amount of residual volume in the wells. If you want the wells entirely empty, move the tips completely to the well bottom or slightly below so that the wash head rests on the bottom of the well.

Table 6. Plate and well shape vs. default aspirate height

Plate / Well shape	Default aspirate height	
96 / Flat	2.6 mm	Default aspirate heights are defined so that the wash head rests on the bottom of the well.
96 / C	2.9 mm	
96 / U	4.2 mm	
96 / V	5.4 mm	
96 / Star	3.1 mm	

- **Aspirate speed** – Define the aspirate rate Low, Medium, or High. The default is *High*.
- **Aspirate time (s)** – The aspirate time ranges from 0 s to 10 s in 1 s increments. The default is 1 s.
- **Dispense height start** – The dispense height start ranges from 0 mm to 17 mm in 0.1 mm increments. The default is *6.0 mm*. Ensure that the value fits the plate in use. Because dispensing starts from a lower level in a well and ends at a higher level, the start height should be lower than or equal to the end height. Refer to Figure 34.
- **Dispense height end** – The dispense height end ranges from 0 mm to 17 mm in 0.1 mm increments. The default is *14.4 mm*. Refer to Figure 34.



Note! Because aspiration is on during dispensing, the end volume in the well depends on the dispense height. If the liquid level in the well during dispensing reaches the wash head tip, then excess liquid is aspirated.



Note! It is possible to dispense more than the well volume and the excess liquid is aspirated, as the aspiration is always on during dispensing. If a so-called overflow volume is selected where the dispense volume is greater than the well volume, ensure that the dispense height end is not outside the well.

- **Final aspirate** – The wells are emptied at the end of the step. The default is *Yes*, which leaves wells empty. *No* leaves the wells wet.

Aspirate



An aspirate step removes liquid from the wells.

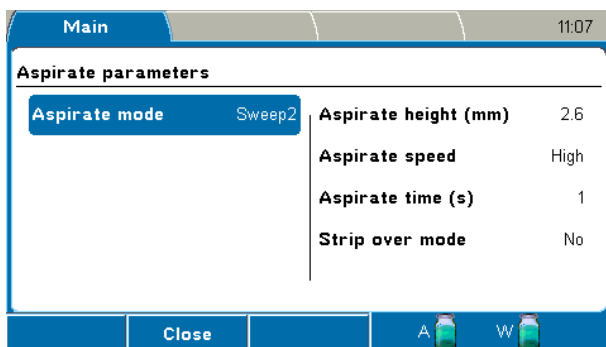

The *Aspirate* step has the following parameters:

- **Aspirate mode** – Define the aspiration mode Normal, Sweep 2, or Sweep 3. The default is *Sweep2*. Sweep is allowed for 96-well plates with flat wells. Refer to Figure 33.
 - **Normal** – There is one aspirate position at the center of the well.
 - **Sweep2** – Aspirate in two different positions across the bottom of the well.
 - **Sweep3** – Aspirate in three different positions across the bottom of the well.
- **Aspirate height (mm)** – The aspirate height ranges from 0 mm to 14 mm in 0.1 mm increments. The default height varies according to the plate type and well shapes (Table 6). Refer to Figure 34.



Caution! Too high an aspirate height increases the residual volume.



Note! The aspirate height determines the amount of residual volume in the wells. If you want the wells entirely empty, move the tips completely to the well bottom or slightly below so that the wash head rests on the bottom of the well.

- **Aspirate speed** – Define the aspirate rate Low, Medium, or High. The default is *High*.
- **Aspirate time (s)** – The aspirate time ranges from 0 s to 10 s in 1 s increments. The default is 1 s.



Caution! A zero second aspirate time will increase the residual volume.

- **Strip over mode** – Define the strip over function. The default is *No*.
 - **No** – All selected strips are processed as fast as possible.
 - **Yes** – If Yes is selected, unused strips are processed dry. The time parameters are measured during the first protocol run. The wash head stays above unused strips for as long as it takes to process each selected strip. This selection is recommended when the timing for washing strips is critical. You can maintain the time between cycles constant with this option.

Dispense



A dispense step fills the wells with liquid.

Dispense parameters	
Dispense volume (µl)	300
Dispense height start	17.0
Dispense height end	17.0
Strip over mode	No

The *Dispense* step has the following parameters:

- **Dispense volume (µl)** –The dispense volume ranges from 50 µl to 400 µl in 10 µl increments. The default value is 300 µl.
- **Dispense height start** – The height at the start of dispensing ranges from 0 mm to 17 mm in 0.1 mm increments. The default is 17.0 mm. Ensure that the value fits the plate in use. Because dispensing starts from a lower level in a well and ends at a higher level, the start height should be lower than or equal to the end height. Refer to Figure 34.
- **Dispense height end** – The height at the end of dispensing ranges from 0 mm to 17 mm in 0.1 mm increments. The default is 17.0 mm. Refer to Figure 34.



Note! Because aspiration is on during dispensing, the end volume in the well depends on the dispense height. If the liquid level in the well during dispensing reaches the wash head tip, then excess liquid is aspirated.

- **Strip over mode** – Define the strip over function. The default is *No*.
 - **No** – All selected strips are processed as fast as possible.

- **Yes** – If Yes is selected, unused strips are processed dry. The time parameters are measured during the first protocol run. The wash head stays above unused strips for as long as it takes to process each selected strip. This selection is recommended when the timing for washing strips is critical. You can maintain the time between cycles constant with this option.

Soak



During a soak step the liquid remains in the wells for the set time with or without shaking of the plate.

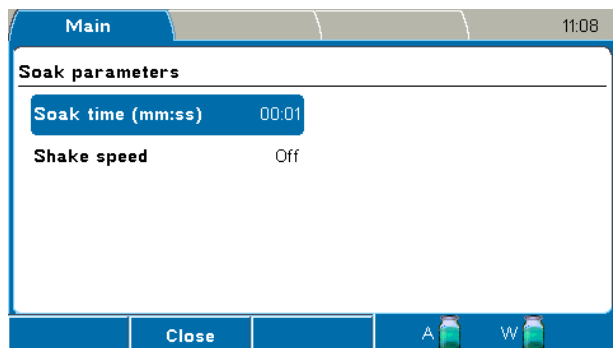

The *Soak* step has the following parameters:

- **Soak time (mm:ss)** – The soak time is the time period between a wash cycle in wash protocols. The minimum value is 00:01 s and the maximum value 60:00 min in increments of 1 s. The default value is 00:01.
- **Shake speed** – Define the shake speed Off, Low, Medium, or High. The default is *Off*.



Caution! Ensure that the liquid does not spill at the shake speed and volume settings in use.



Caution! The instrument is not intended for shaking purposes only. A separate microplate shaker is available if needed (e.g. iEMS Incubator/Shaker). Refer to www.thermoscientific.com.

Prime



The prime step is performed to fill the liquid tubing completely from the buffer bottle intake tube to the wash head tips. The default priming volume is 30 ml in order to fill the liquid tubing properly. The dead volume of the liquid line is 19 ml (see Figure 30).



Note! Avoid unnecessary priming with air because it may damage the pump.

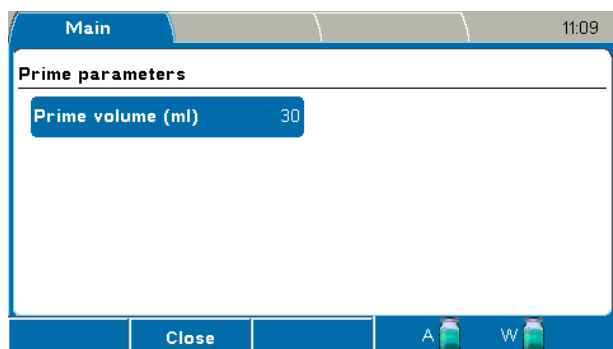

The *Prime* step has the following parameter:

- **Prime volume (ml)** – The prime volume ranges from 5 ml to 100 ml in 5 ml increments. The default is *30 ml*.

Priming is carried out in the priming position. Aspiration is on while priming. At the end, the priming vessel is emptied and the wash head returns to the home position.

Pause



You can stop a protocol momentarily and then start the protocol again.

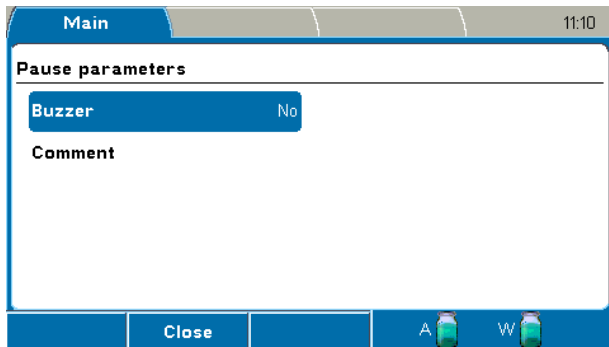

The *Pause* step has the following parameters:

- **Buzzer** – Set the buzzer on (= Yes) or off (= No). There is a beep when the Pause step starts. The default is *No*.
- **Comment** – You can add text, for example, instructions. There is space for 128 characters.

To end the Pause step, press the **OK** button to continue protocol execution. A three second alarm is sounded.

Layout

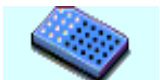

The *Layout* step is used to predefine the strip selection for a protocol. This step determines the area on which the next steps are processed.

The layout is *landscape* when a 1x8 wash head is selected and *portrait* for a 1x12 wash head. The strips are numbered 1–12 if a 1x8 wash head is used and marked A–H for a 1x12 wash head.

If there is no Layout step in the protocol, the processed area is according to the Main > **Layout** row selection.



Note! Only the strips that are selected for the Layout step are saved with the protocol. Strips selected using the **Layout** row are not saved.

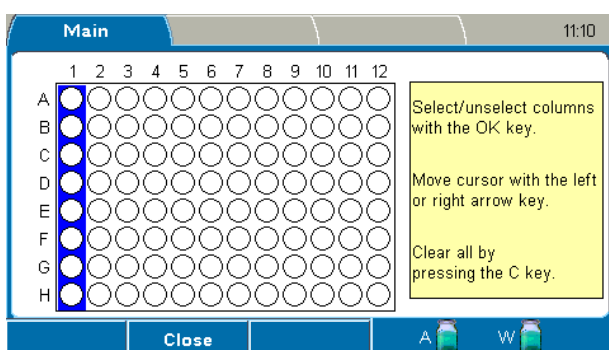

The selected strips are highlighted in **red**.

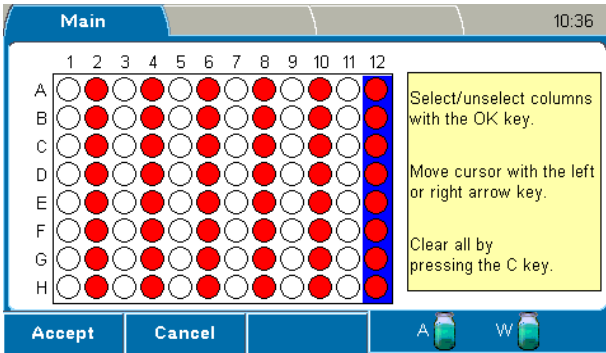

Note! If the Layout step is the first step in the protocol, the selected wells are shown in **blue** on the **Layout** row in the **Main** menu. The **Layout** row is then locked.

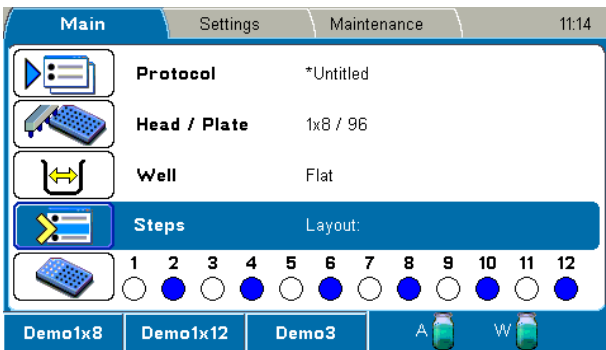

If the Layout step is used, it is recommended to use the step as the first step in the protocol. If the Layout step is not the first step in the protocol, the **Layout** row is not locked but enabled. You can select strips using the row until the first Layout step in the protocol is encountered.

Settings menu

The **Settings** menu contains the **Prime parameters**, **Sensors**, **Wash head configuration**, **System**, and **Reports** parameters.



Prime parameters



Select the **Prime parameters** row in the **Settings** menu and press the **OK** button.

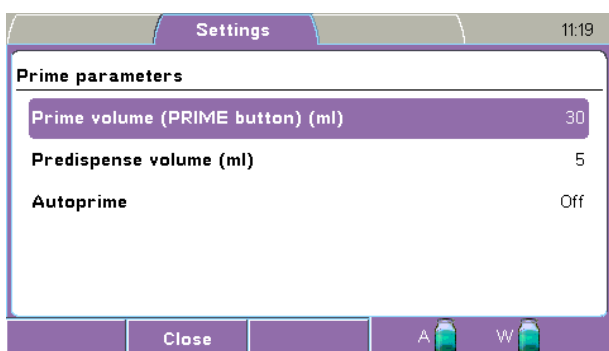

Warning! If you activate the **Autoprime** parameter, ensure that the wash head is firmly attached. Failure to do so may result in spillage.

The **Prime parameters** window has the following parameters:

- **Prime volume (Prime button) (ml)** – The prime volume ranges from 5 ml to 100 ml in 1 ml increments. The default is *30 ml*.
- **Predispense volume (ml)** – This volume is dispensed before the start of each dispensing to ensure accurate dispensing. The predispense volume ranges from 1 ml to 20 ml in 1 ml increments or it can be set Off. The default is *5 ml*.
- **Autoprime** – This primes the instrument at a set interval to ensure that the instrument stays primed. Autoprime is not recommended for long time intervals (overnight). Use instead the Soak wash head function. Refer to “Soak wash head”.
 - **Volume (ml)** – The autoprime volume ranges from 1 ml to 30 ml in 1 ml increments. The default is *5 ml*.
 - **Time (hh:mm)** – The time ranges from 0:00 (= Off) to 9:00 in increments of 15 min. The default is *Off*.



Note that the **blue** clock icon appears on the menu bar when **Autoprime** is active.



Warning! Multiple occasions of autoprime may empty the buffer bottle.

Sensors

Liquid level sensors are built into the caps of both bottles to avoid overflow of the waste bottle and to warn the user when the buffer bottle is almost empty.

The liquid level sensors can be enabled or disabled in the **Sensors** window.



Caution! If the sensors are disabled, there will be no warning prior to the buffer bottle being empty or the waste bottle full. Failure may result in a weakened or faulty wash result, liquid spillage or biohazard.



Select the **Sensors** row in the **Settings** menu and press the **OK** button.

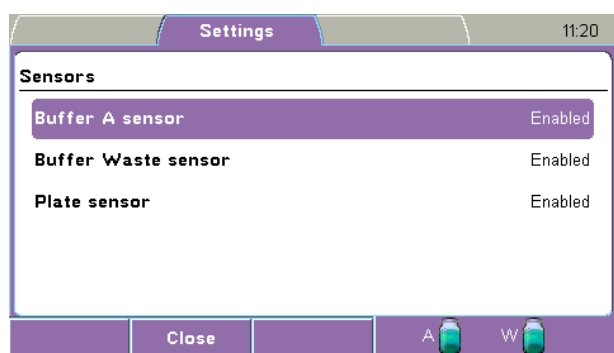

The **Sensors** window has the following parameters:

- **Buffer A sensor** – Disable or enable the buffer A sensor. The default is *Enabled*.
- **Buffer Waste sensor** – Disable or enable the buffer Waste sensor. The default is *Enabled*.
- **Plate sensor** – Disable or enable the plate sensor. The default is *Enabled*. When enabled, the instrument checks whether there is a plate on the plate carrier at the beginning of the protocol run.



Caution! If the plate sensor is disabled, there will not be a warning indicating a missing plate. A missing plate may result in spillage.

Wash head configuration

You must always set the wash head configuration to correspond to the physically installed wash head. Refer to “Head / Plate”.



Select the **Wash head configuration** row in the **Settings** menu and press the **OK** button.

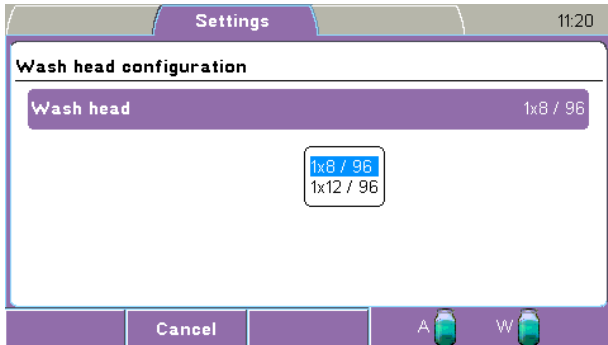

The **Wash head configuration** window has the following parameters:

- **Wash head** – Ensure that the installed wash head is the same as set in the **Wash head configuration** window. Press the **OK** button to select the correct wash head from the list:
 - **1x8 / 96**
 - **1x12 / 96**



Warning! An incorrect wash head configuration can cause liquid spillage or a faulty washing performance.



Warning! If the error message shown below appears, calibrate the wash head before use.

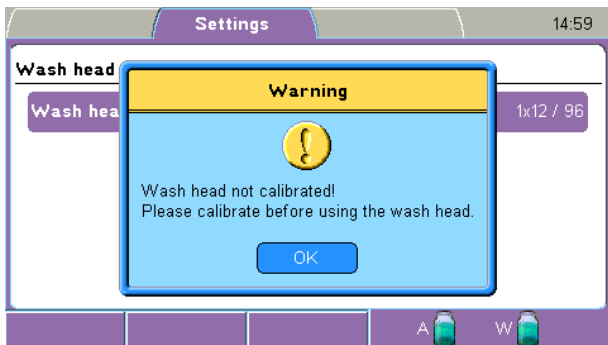

System

The system parameters are set in the **System** window.



Select the **System** row in the **Settings** menu and press the **OK** button.



The **System** window has the following parameters:

- **Date and time** – The date and time is set in the *dd.mm.yyyy hh:mm:ss* format.
- **Date format** – Select the date format *dd-mm-yyyy*, *dd/mm/yyyy*, *dd.mm.yyyy*, *yyyy-mm-dd*, or *mm/dd/yyyy*. The default is *dd.mm.yyyy*.
- **Time format** – Select the time format 12 hour or 24 hour. The default is *24 hour*.
- **Buzzer** – Disable or enable the buzzer. The alternatives are All on, Keyb off, or All off. All the warning signals are off in All off. The default is *Enabled* and *All on*.
- **Language** – Set the preferred user interface language. The default is *English*.
 - **English**
 - 中文 (= Chinese)
 - **Français** (= French)
 - **Deutsch** (= German)
 - 日本語 (= Japanese)
 - **Português** (= Portuguese)
 - **Русский** (= Russian)
 - **Español** (= Spanish)
 - **Italiano** (= Italian)

The following information is also visible in the **System** window:

- **Version** – Version of the software
- **SN** – Serial number of the instrument
- **Protocol ver** – Version of the protocol parameter set. For the best compatibility, ensure that the protocols are of the same version.
- **Memory used** – The amount of protocol memory that is in use as a percentage of total memory.

Reports

You can export the available reports to a USB memory device for viewing, printing, or saving.

To export a report, attach a USB memory device to the USB memory device port in the instrument, select the desired report and press the **OK** button. The selected report is exported to the USB memory device under an automatically generated folder named *“WELLWASH”*.

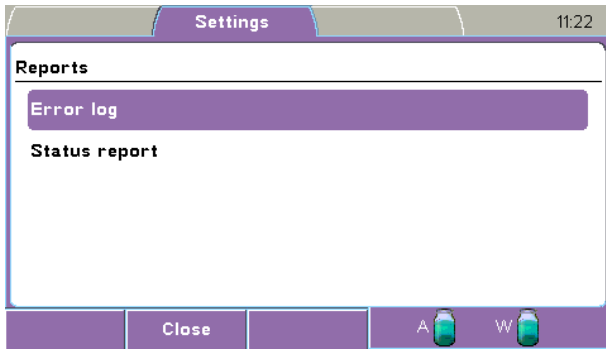

The reports available are:

- **Error log** – The error log shows the date and time of the error and the error(s).
- **Status report** – The status report shows the following parameters: report name, date and time, instrument name, version and serial number, current protocol, prime and rinse parameters, sensor settings and status, wash head configuration, system settings, calibration parameters for all wash heads, offset values, and pump usage hours.

Maintenance menu

You can perform the maintenance procedures in the **Maintenance** menu.

The **Maintenance** menu contains the **Clean**, **Calibration**, and **Service** parameters.

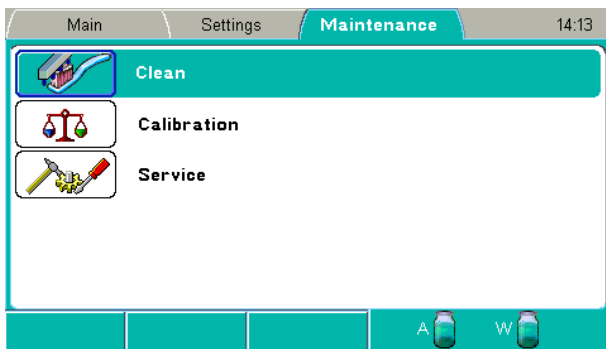

Clean

Cleaning and disinfection procedures are set in the **Clean** window.

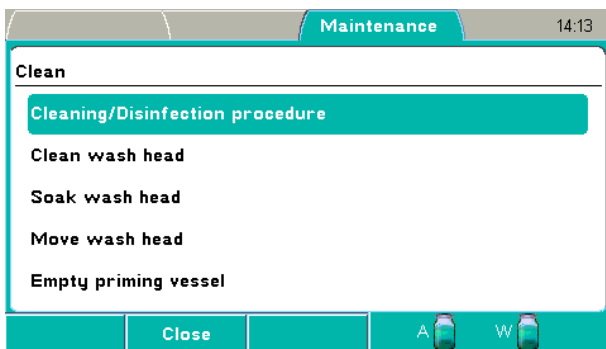

The **Clean** window has the following parameters:

- **Cleaning/Disinfection procedure** (see “Cleaning/Disinfection procedure”)
- **Clean wash head** (see “Clean wash head”)
- **Soak wash head** (see “Soak wash head”)
- **Move wash head** (see “Move wash head”)
- **Empty priming vessel** (see “Empty priming vessel”)

Cleaning/Disinfection procedure

The procedure cleans or disinfects the instrument according to a set of actions. Refer to Chapter 11: “Maintenance”, particularly “Decontamination procedure”.



1. Press the **OK** button on the **Cleaning/Disinfection procedure** row.

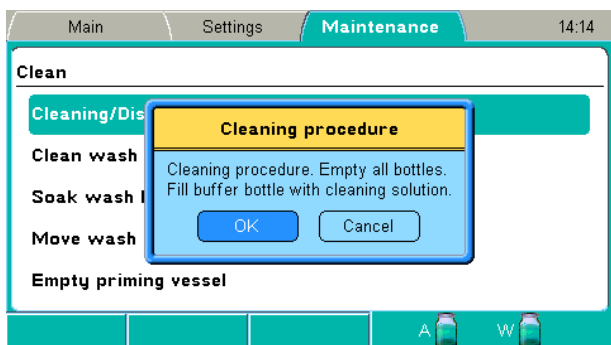

2. Empty all bottles and fill the buffer bottle with cleaning reagent. Press the **OK** button.

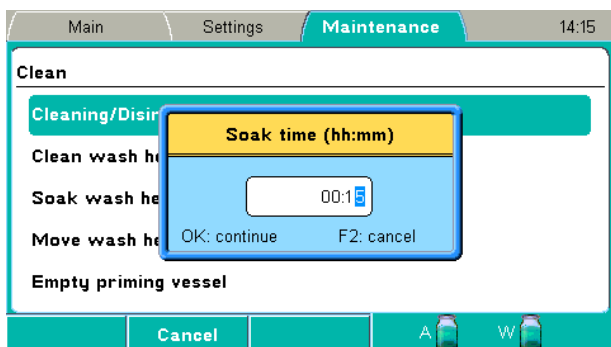

3. Select the soak time using the **Right** arrow key and number keys. The default is *15 min*. Press the **OK** button.

Priming, preparing the soak and soaking take place.

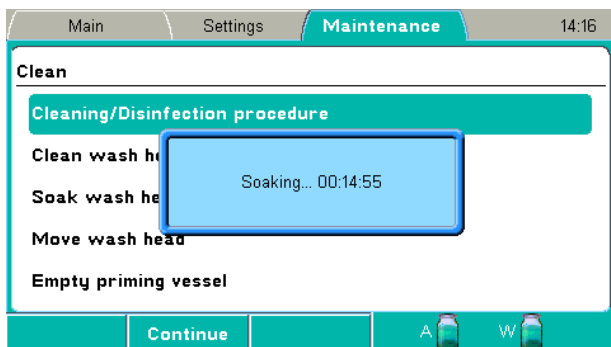

4. Press the **F2** key to abort the soaking if you want a shorter soak time than the set soak time and to continue the procedure. Priming is then carried out.

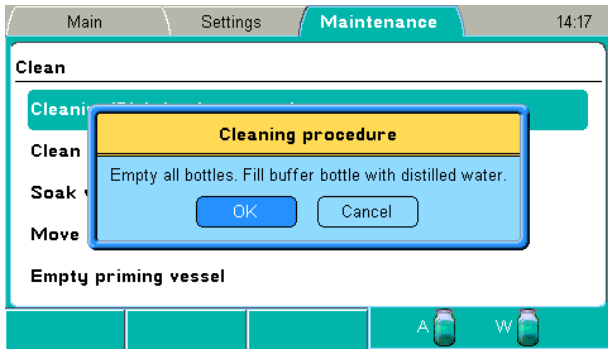

5. Empty all bottles and fill the buffer bottle with deionized distilled water. Press the **OK** button.

Priming, preparing the soak and soaking take place. The default soak time is 2 s. Finally the priming vessel is emptied.

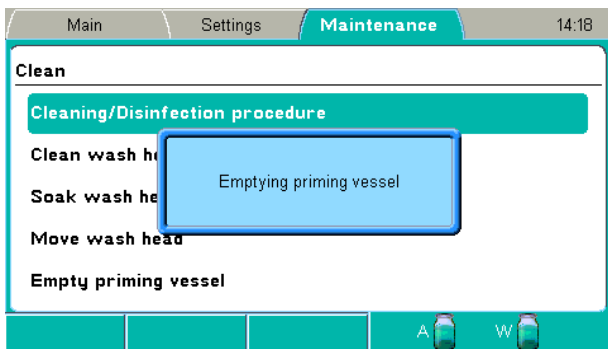

6. Empty all bottles and press the **OK** button.

Priming is then carried out.

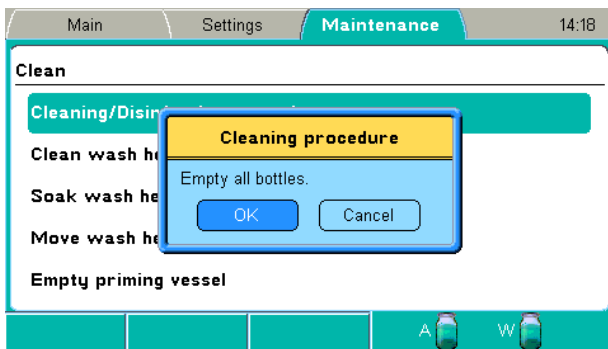

7. Press the **OK** button when the procedure is ready.

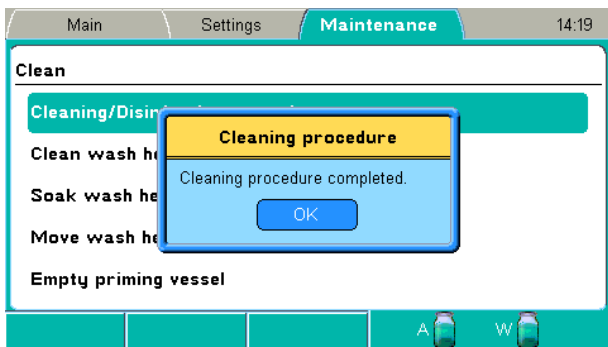

Clean wash head

The procedure cleans the wash head according to a set of actions. Carry out this procedure if the wash head is dirty or clogged.

The instrument fills the priming vessel with a selected liquid and soaks the wash head for a selected period of time.



Note! Use a suitable cleaning agent and repeat the *Clean* procedure with deionized distilled water.



1. Select the **Clean wash head** row and press the **OK** button.

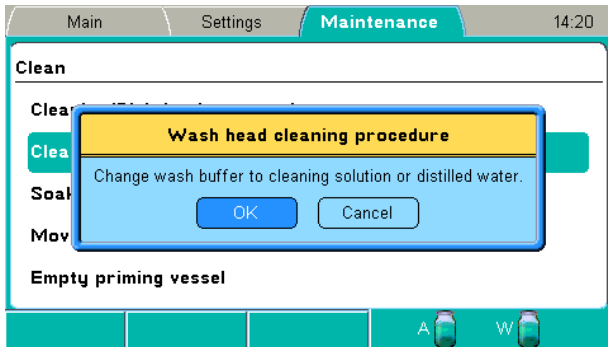

2. Change the wash buffer to cleaning agent or deionized distilled water. Press the **OK** button.

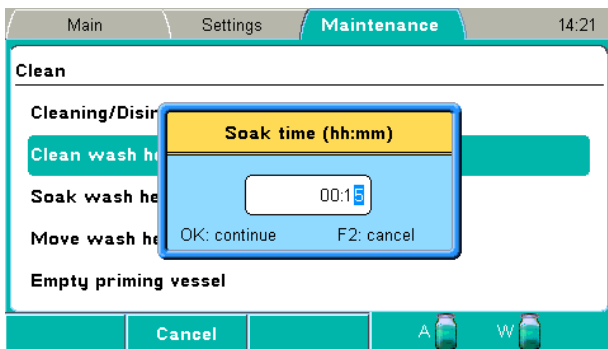

3. Select the soak time using the **Right** arrow key and number keys. The default is *15 min*. Press the **OK** button.

Priming, preparing the soak and soaking take place.

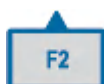
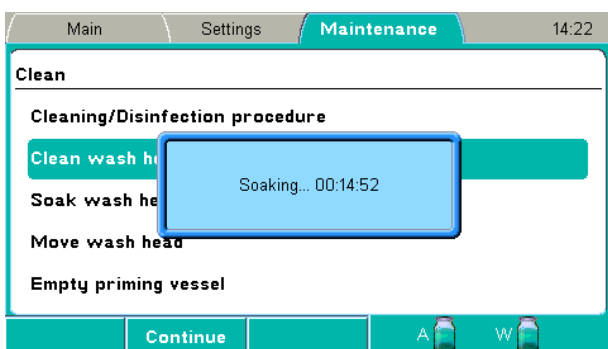

4. Press the **F2** key to stop the soaking if you want a shorter soak time than the set soak time and to continue the procedure. Priming is then carried out.

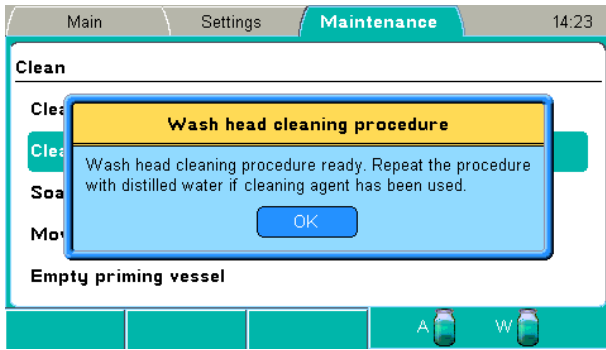

5. Press the **OK** button when the procedure is ready.

Repeat the wash head cleaning procedure with deionized distilled water if cleaning agent has been used.



Note! If the tips are still clogged, refer to “Cleaning the wash head”.

Soak wash head

The procedure soaks the wash head according to a set of actions. The wash head is soaked in liquid (standby) to prevent clogging. The instrument fills the priming vessel with a selected liquid and leaves the wash head immersed in the solution. This procedure can be used for a shorter period of time between washes using a wash buffer or to soak for an extended period, for example, overnight, using deionized distilled water.



1. Select the **Soak wash head** row using the **Down** arrow key and press the **OK** button.

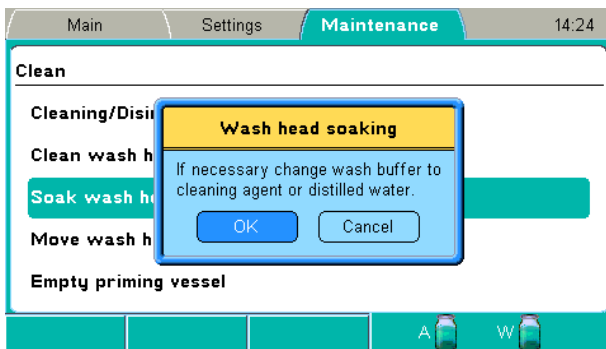

2. Change the wash buffer to cleaning agent or deionized distilled water if needed. Press the **OK** button.

Priming, preparing the soak and soaking take place.

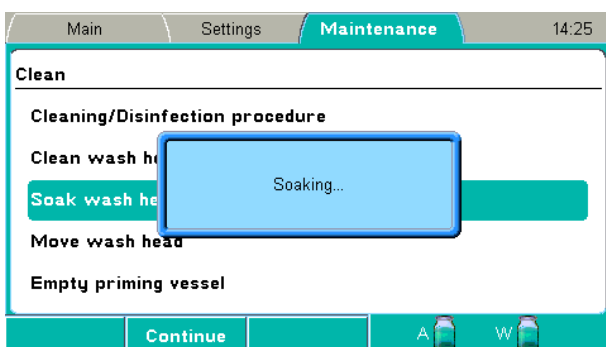



3. Press the **F2** key to abort the soaking and to continue the procedure. The priming vessel is emptied.

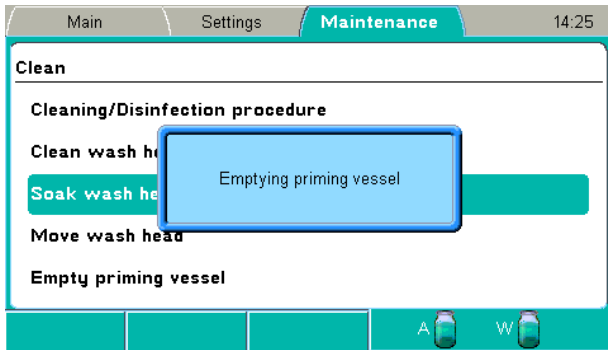

4. Press the **OK** button when the procedure is ready.

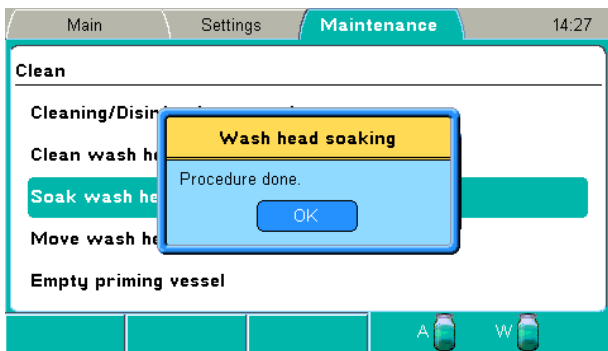

Move wash head

The procedure moves the wash head down into the priming vessel to the soak position. You need to add deionized distilled water or a suitable cleaning agent manually into the priming vessel.

This procedure can be used to leave the wash head in liquid (standby) or when a clogged wash head is cleaned and the instrument pump cannot be used to fill the priming vessel.



1. Select the **Move wash head** row using the **Down** arrow key and press the **OK** button.

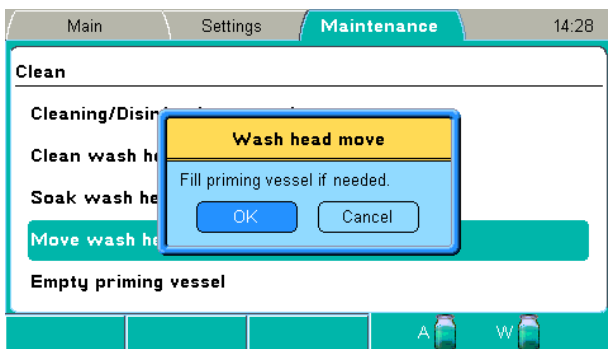

2. Fill the priming vessel manually if needed. Press the **OK** button. Preparing the soak and soaking take place.

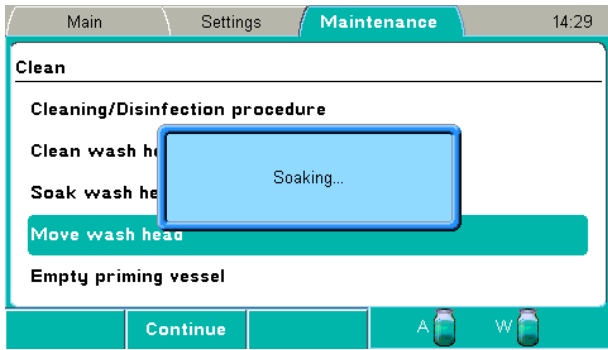

3. Press the **F2** key to end the procedure.



Empty priming vessel

The procedure aspirates the priming vessel empty of liquid. The procedure can be carried out, for example, after the *Move wash head* procedure. Refer to “Move wash head”.



1. Select the **Empty priming vessel** row using the **Down** arrow key and press the **OK** button.

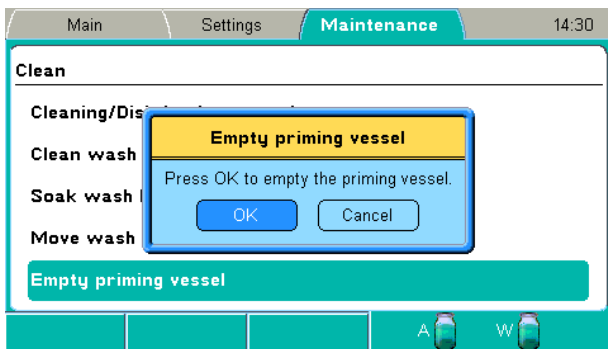

2. Press the **OK** button to empty the priming vessel.



The priming vessel is emptied.

3. Press the **OK** button when the procedure is done.



Calibration

The wash head supplied with the instrument is calibrated during production. The wash head box includes an instrument serial number to which it has been calibrated. Refer to “Active calibration”.

Ensure that the wash head type corresponds to the wash head setting in the Settings menu. Each wash head type has its own calibration.



Note! An optional wash head must be calibrated by the user.



Note! It is recommended to check the dispense accuracy regularly and calibrate if necessary. Refer to Chapter 11: “Maintenance”.



Note! After the calibration procedure, verify the accuracy by dispensing the required volume onto a plate.

Required tools:

- Calibrated laboratory scale with 0.0001 g resolution
- 4+1 96-well plates
- Approximately 500 ml of liquid

The purpose of the calibration is to calibrate the liquid system to dispense accurate volumes. Refer to Figure 24, Liquid system diagram. The instrument controls the dispensed volume by adjusting the dispense pump speed and valve open time.

Calibration is performed at 100 μ l and 300 μ l. The weighed liquid mass of each plate is entered into the Weight fields in the table in grams. The software calculates the internal values of the mean volume per well and the accuracy % for reference use only. The instrument uses linear regression to calculate the dispense valve open time versus volume.

Starting the calibration



Note! Ensure that the wash head type corresponds to the wash head setting in the **Settings** menu.



Note! Before running the calibration, make sure that the liquid system operates correctly, for example, that the liquid filter and wash head tips are clean.



Select the **Calibration** row in the **Maintenance** tab and press the **OK** button.



The following calibrations are available:



Active calibration

- **Factory** – For service purposes only. This can only be temporarily activated and is active until the power is turned off.
- **User** – The date of the last calibration is shown, initially the date of the calibration in production.

Calibrate current wash head

The calibration is used for calibrating the wash head.



Note! A new wash head of the same kind must be calibrated before use.

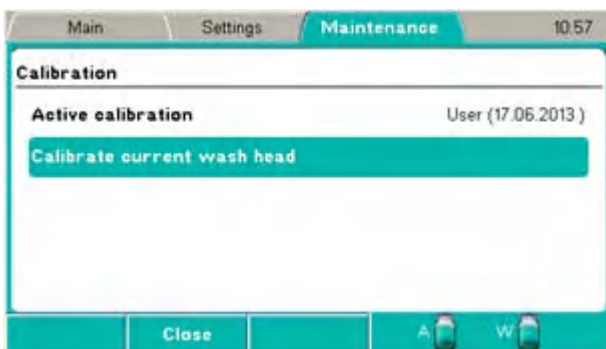

1. Select the **Calibrate current wash head** row and press the **OK** button.

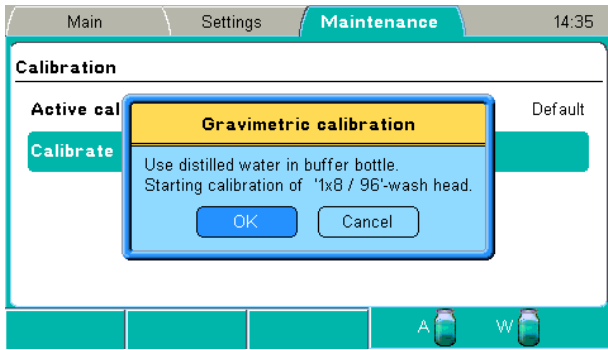

2. Press the **OK** button to start the calibration. The dispense pump speed is first calibrated.

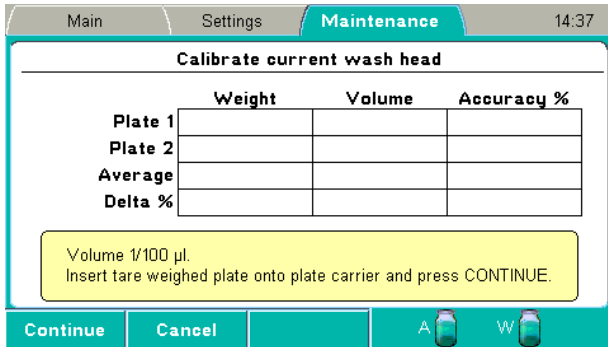

3. Insert the first tare weighed plate onto the plate carrier and press the **F1** key to continue. Dispensing is carried out.

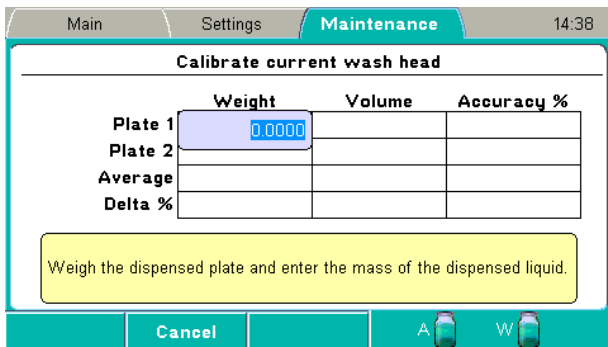

4. Weigh the dispensed plate and enter the mass of the dispensed liquid in grams using the number keys.

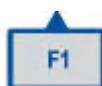
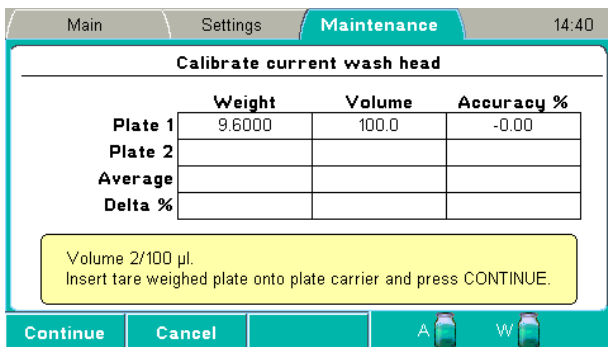

5. Insert the second tare weighed plate onto the plate carrier and press the **F1** key to continue. Dispensing is carried out.

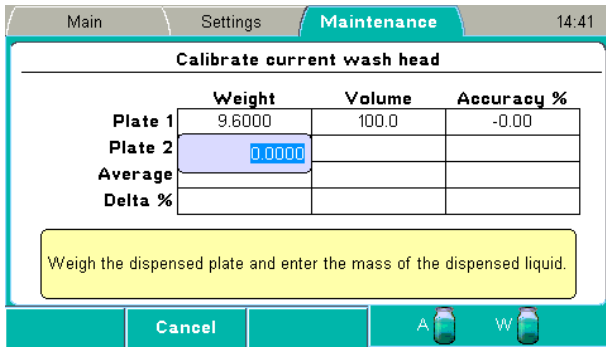

6. Weigh the dispensed plate and enter the mass of the dispensed liquid in grams using the number keys.

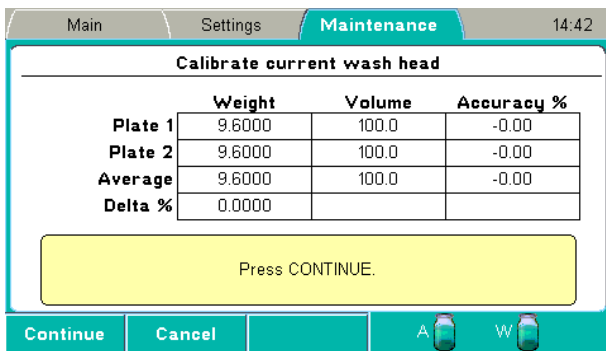

7. Press the **F1** key to continue calibration.

OR

Press the **F2** key to cancel calibration.

OR

Press the **F3** key to repeat calibration when the software informs that the Delta% or accuracy are not acceptable. (The accuracy of the first plate must be $\pm 50\%$ and that of the second plate must be $\pm 5\%$.)

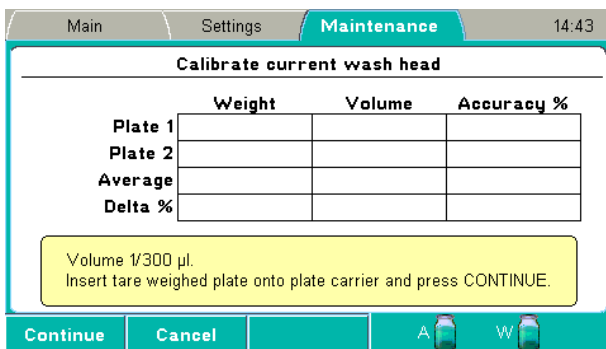

8. Continue dispensing and weighing the third and fourth plate in the same way.

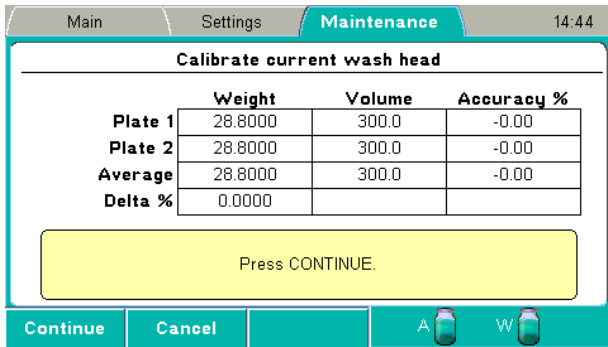

9. Press the **F1** key to continue calibration.

OR

Press the **F2** key to cancel calibration.

OR

Press the **F3** key to repeat calibration when the software informs that the Delta% or accuracy are not acceptable. (The accuracy must be 2.5 to 3.5 x that of 100 µl.)

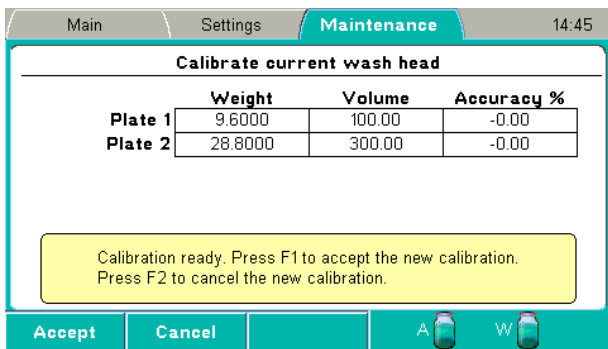

10. Calibration is now complete. Press the **F1** key to accept the new calibration.



Note! Calibration for the wash head is saved and it becomes the active calibration.



11. Press the **OK** button when the procedure is done.

12. Verify the new performance by dispensing a plate, for example, with 300 µl. Tare weigh the plate, dispense and measure the weight to determine the actual dispensed volume.

Calculation method: $\text{Weight [mg]} / 96 = \text{Volume/well [\mu l]}$

Service

Service procedures are set in the **Service** window.

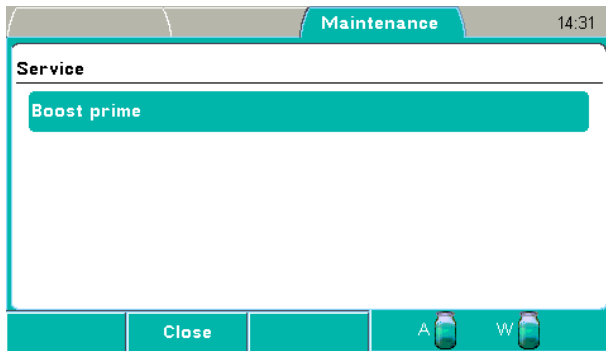

The **Service** window has the following parameter:

- **Boost prime** – Use the Boost prime option when no liquid enters the tubing during priming.



Warning! There is a risk of liquid spillage if Boost prime is not stopped when liquid starts to flow and reaches the wash head.



Note! The liquid level sensors must be enabled (Settings > **Sensors**) to allow boost priming. Refer to “Sensors”.



Note! Attempt the Prime function before performing the Boost prime option. Refer to “Priming the system”.

Fill the buffer bottle completely with suitable liquid (e.g. tap water) and enable the liquid level sensors.



Start the Boost prime option by pressing the **OK** button. The pump speed is increased in steps to maximum speed. To prevent splashing, press the **OK** button or the **STOP** button to interrupt the sequence when liquid starts to flow in the tubing. Continue with the normal Prime operation. Empty the priming vessel (Maintenance > Clean > **Empty priming vessel**) if necessary.



If there is still no liquid flowing, refer to “Manual priming”.

Chapter 7: Exporting and Importing

It is possible to export and import the stored protocols to or from one instrument to another of the same type.

Exporting a protocol

To export a protocol from the instrument to a USB memory device:

1. Insert the USB memory device (Figure 35).



Figure 35. USB memory device inserted



2. Go to the **Protocol** row in the **Main** menu and press the **OK** button. The list of protocols appears.

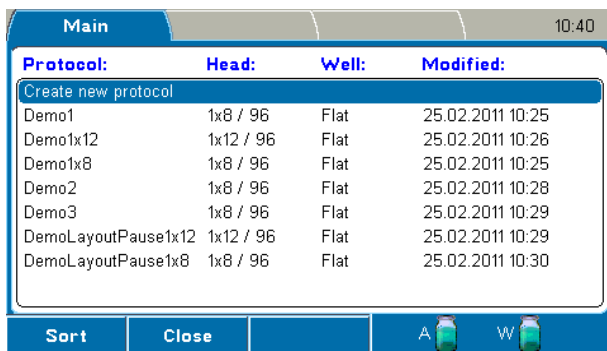

3. Select the protocol you want to export.

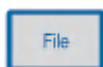

4. Press the **FILE** key to open the **File** menu.

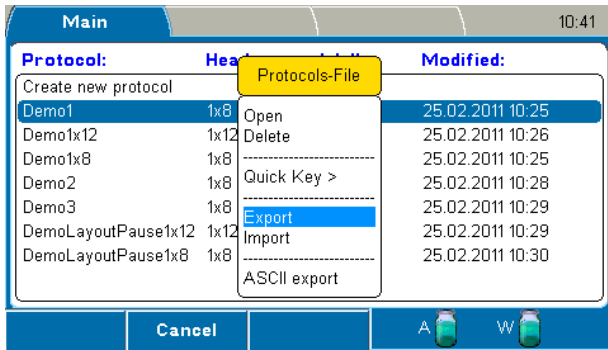

5. Select **Export** and press the **OK** button.



The protocol is exported to the USB memory device under an automatically generated folder named “WELLWASH”. The file extension of an exported protocol is .PRO. The file is in binary format. You can export protocols one at a time.

Ensure that exporting overwrites a protocol if it already exists on the USB memory device.

When importing, ensure that the same protocol name is not used.

Importing a protocol

To import a protocol from a USB memory device to the instrument:

1. Insert the USB memory device (Figure 35).

2. Go to the **Protocol** row in the **Main** menu and press the **OK** button. The list of protocols appears.

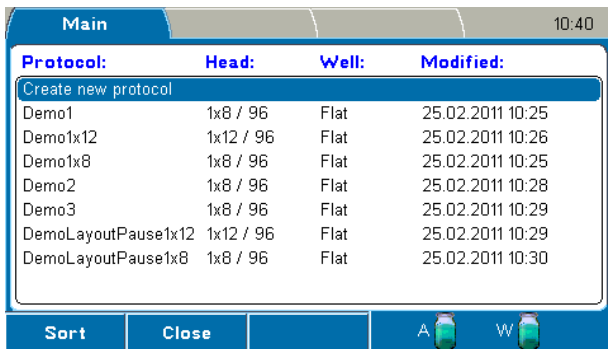

3. Press the **FILE** key to open the **File** menu.

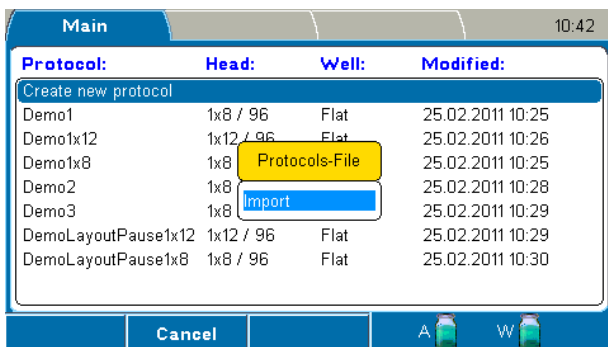



4. Select Import and press the **OK** button.

A list of protocols stored on the USB memory device opens.

The list also shows protocols of the Wellwash Versa instrument if they are stored on the memory device. They cannot be imported.

USB protocol:	Head:	Well:	Modified:
Demo1	1x8 / 96	Flat	29.04.2010 09:00
Demo1x12	1x8 / 96	Flat	23.02.2011 20:45
Demo1x8	1x8 / 96	Flat	23.02.2011 20:39
Demo2	1x8 / 96	Flat	29.04.2010 09:02
Demo3	1x8 / 96	Flat	29.04.2010 09:04
DemoLayoutPause1x12	1x8 / 96	Flat	23.02.2011 21:03
DemoLayoutPause1x8	1x8 / 96	Flat	23.02.2011 20:58



5. Select the protocol you want to import and press the **OK** button. You can import protocols one at a time.

USB protocol:	Head:	Well:	Modified:
Demo1	1x8 / 96	Flat	29.04.2010 09:00
Demo1x12	1x8 / 96	Flat	23.02.2011 20:45
Demo1x8	1x8 / 96	Flat	23.02.2011 20:39
Demo2	1x8 / 96	Flat	29.04.2010 09:02
Demo3	1x8 / 96	Flat	29.04.2010 09:04
DemoLayoutPause1x12	1x8 / 96	Flat	23.02.2011 21:03
DemoLayoutPause1x8	1x8 / 96	Flat	23.02.2011 20:58

The protocol is imported to the instrument and it is available on the list of protocols.

Exporting protocols as text files

You can export a protocol as a text file to a USB memory device. The text file has information about the protocol, such as the name, the steps and their parameters, modification date, wash head, well type and well offset.

1. Insert the USB memory device (Figure 35).



2. Go to the **Protocol** row in the **Main** menu and press the **OK** button. The list of protocols appears.

Protocol:	Head:	Well:	Modified:
Create new protocol			
Demo1	1x8 / 96	Flat	25.02.2011 10:25
Demo1x12	1x12 / 96	Flat	25.02.2011 10:26
Demo1x8	1x8 / 96	Flat	25.02.2011 10:25
Demo2	1x8 / 96	Flat	25.02.2011 10:28
Demo3	1x8 / 96	Flat	25.02.2011 10:29
DemoLayoutPause1x12	1x12 / 96	Flat	25.02.2011 10:29
DemoLayoutPause1x8	1x8 / 96	Flat	25.02.2011 10:30



3. Select the protocol you want to export.

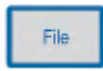

4. Press the **FILE** key to open the **File** menu.

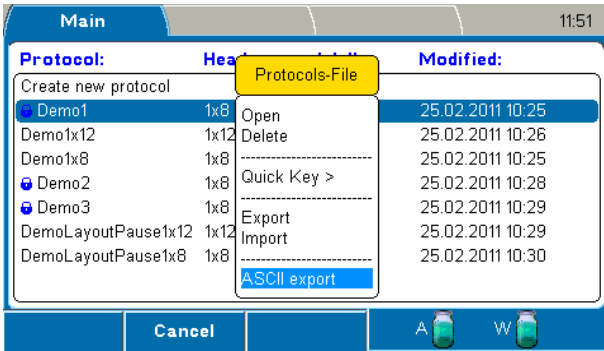

5. Select **ASCII Export** and press the **OK** button.

The protocol is exported to the USB memory device. The ASCII exported file name is the same as that of the binary file with the .TXT extension. You can open the file with a text editor, print it or save it.

Chapter 8: Deleting

Deleting a protocol



1. Go to the **Protocol** row in the **Main** menu and press the **OK** button. The list of protocols appears.

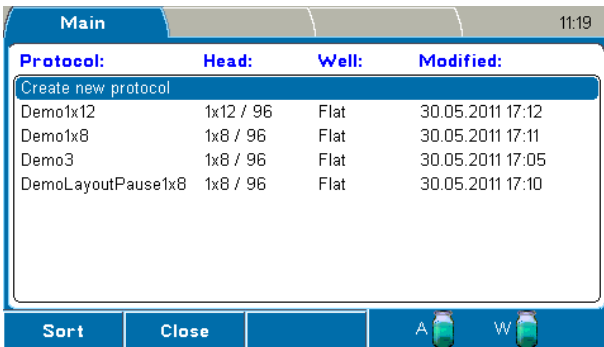

2. Select the protocol you want to delete.

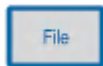

3. Press the **FILE** key to open the **File** menu.

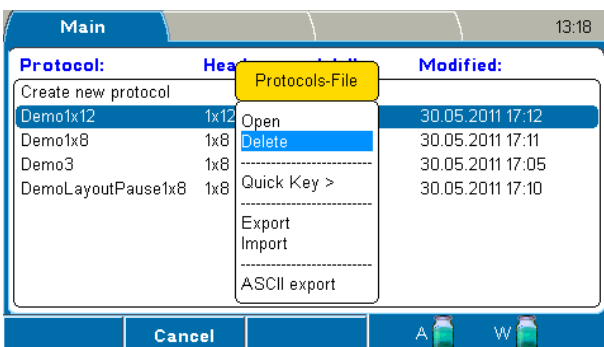



4. Select **Delete** and press the **OK** button.

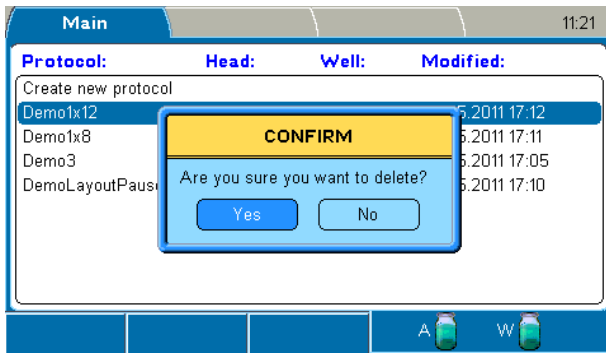

5. Select **Yes** and press the **OK** button to confirm the deletion.

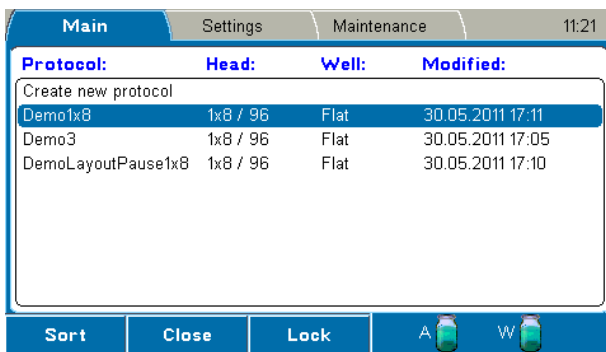

The wash protocol has now been deleted.

Chapter 9: Shutdown

Shutting down

It is recommended to shut down the Wellwash at the end of each working day.

1. Remove any plate still in the instrument.
2. Empty the buffer bottle and fill it with deionized distilled water.
3. Prime the liquid system with deionized distilled water to remove any buffer solution from the liquid lines and wash head. The rinsing procedure should be performed if the instrument is left to stand or is switched off at the end of operation.

If the instrument is left to stand for a short time during the same day, the wash head can be immersed in wash buffer or deionized distilled water. Refer to “Soak wash head” and “Move wash head”.



Caution! If the wash head is not rinsed, the tips may become clogged. If this occurs, the wash head will need to be cleaned, repaired or may have to be replaced.

4. If the instrument is left to stand for a longer time, priming must be performed with air to remove all liquid from the system. Raise the intake tube from the liquid to allow air to enter the tube.
5. Switch off the instrument.
6. If you have spilled infectious agents on the instrument, decontaminate with 70% ethanol or another disinfectant (see “Decontamination procedure”).
7. Finally empty the waste bottle.



Warning! The wash head and priming vessel may be contaminated after the instrument has been used.



Warning! When handling the waste bottle, it is advisable to observe applicable safety precautions, including the wearing of disposable powder-free gloves, safety glasses and protective clothing, to avoid potential infectious disease contamination.

Chapter 10: Emergency Situations

Handling abnormal situations

If there is an abnormal situation during the operation, such as fluids spilling inside the instrument, follow these steps:

1. Switch off the instrument (Figure 23).
2. Unplug the instrument immediately from the power supply (Figure 22).
3. Carry out appropriate corrective measures. Do not disassemble the instrument.
4. If the corrective measures taken do not help, contact authorized technical service or your local Thermo Fisher Scientific representative.

Chapter 11: Maintenance

Regular and preventive maintenance

Contact local authorized technical service or your local Thermo Fisher Scientific representative for assistance, if needed. Refer to Table 7.

Maintenance checklist

Table 7. Maintenance checklist

Item	d.	wk.	mo.	yr.	If req.
Perform the operational check. See "Performing the operational check after switching on".	✓				
Prime the instrument with deionized distilled water after use. See "Instrument care".	✓				
Keep the instrument free of dust. See "Instrument care".	✓				
Wipe away spilled saline solutions, solvents, acids or alkaline solutions from outer surfaces immediately to prevent damage, and wipe with deionized distilled water. See "Cleaning of the instrument".	✓				
If any surfaces have been contaminated with biohazardous material, decontaminate with a mild sterilizing solution. See "Instrument care".	✓				
Clean the case of the instrument periodically. See "Cleaning of the instrument".		✓			
Clean the plate carrier if needed. See "Cleaning the plate carrier".		✓			
Check the operation of the plate clamp.	✓				
Clean the priming vessel if needed. See "Cleaning the priming vessel".					✓
Clean the liquid bottles regularly. See "Cleaning liquid bottles".	✓	✓			
Clean or replace the liquid filter (Figure 37) of the intake tube if needed. See "Cleaning liquid bottles".			✓		✓
Check the performance of the liquid sensors. See "Checking the liquid level sensors".	✓				
Clean the wash head daily and replace if needed. See "Cleaning and replacing the wash head".	✓				✓
Check the dispensing accuracy and calibrate if needed. See "Checking the dispense accuracy" and "Calibration".			✓	✓	
Check the aspirate height. See "Checking the aspirate height".			✓	✓	
Replace the tubings if needed. Contact service.					✓
Ensure proper shutdown. See Chapter 9: "Shutdown".	✓	✓			
Decontaminate the instrument when relocating the instrument or sending it for service. See "Decontamination procedure".					✓
Service the instrument regularly. See "Cleaning of the instrument" and "Maintaining a system log".				✓	

✓ = depending on the laboratory conditions and the use and configuration of the instrument

Instrument care

Routine and service procedures must be performed by the user to prevent unnecessary wear or hazards and are described below at the frequency with which they should be applied.

Always ensure that the electrical supply in the laboratory conforms to that specified on the type label of the instrument.

To guarantee continuous reliability and accuracy of the Wellwash:

- Prime all the channels of the instrument with deionized distilled water after use.
- Prevent any liquid from entering the instrument.
- Keep the instrument free of dust and other foreign matter.
- Perform operational checks regularly (see “Performing the operational check”).

In the event of any damage, contact your local Thermo Fisher Scientific representative for service.

Abrasive cleaning agents are not recommended, because they are likely to damage the paint finish.

It is recommended that you clean the case of the instrument periodically to maintain appearance (see “Cleaning of the instrument”).

Clean the keypad and display surface with a mild laboratory detergent.

Plastic covers and surfaces may be cleaned with a mild laboratory detergent, mild bleach or diluted alcohol solution.



Warning! If any surfaces have been contaminated with biohazardous material, a mild sterilizing solution should be used.



Caution! Do not use the instrument to aspirate or dispense strong acidic or alkaline solutions as this could damage the instrument.



Caution! Never use acetone as it will damage the covers.



Caution! Do not autoclave any part of this instrument apart from those specified in Table 8 and Figure 38.

Cleaning of the instrument

Clean the instrument regularly as stated below.



Caution! Although the Wellwash is constructed from high-quality materials, you must immediately wipe away spilled saline solutions, solvents, acids or alkaline solutions from the outer surfaces to prevent damage and wipe them with deionized distilled water.



Caution! Painted surfaces may be cleaned with most laboratory detergents. Dilute the cleaning agent as recommended by the manufacturer. Do not expose painted surfaces to concentrated acids or alcohols for prolonged periods as damage may occur.

1. Turn the power off and unplug the instrument.
2. Use disposable powder-free gloves.
3. Clean the instrument exterior and the plate carrier with a soft cloth dampened with water or mild detergent.
4. If you have spilled infectious agents on the instrument, decontaminate the instrument. Refer to “Decontamination procedure”.



Caution! Do not use solutions containing hypochlorite, such as bleach, on the stainless steel surfaces, as this may cause permanent damage to the finish.

Salt deposit

Depending on the concentration of the wash buffers, crystallization may occur around the dispense tips and bottle necks. Therefore, regular cleaning of these parts is essential. Refer to “Cleaning liquid bottles” and “Clean wash head”.

Cleaning the priming vessel

The instrument comes with the priming vessel installed. The priming vessel is correctly installed if it stays in place and does not move up. The priming vessel is removed for maintenance purposes only.

To remove the priming vessel:

1. Push the priming vessel away from yourself towards the instrument until you hear a snap.
2. Lift the priming vessel up and remove it (Figure 36).

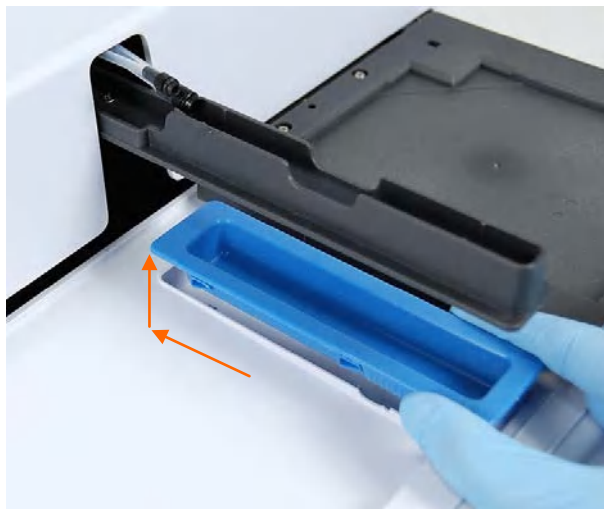

Figure 36. Removing the priming vessel

3. Clean the priming vessel with a mild detergent and rinse with deionized distilled water.
4. Replace the priming vessel by inserting it downwards and pulling it towards yourself.



Warning! The priming vessel may be contaminated after the instrument has been used.

Cleaning the plate carrier



Caution! Do not disassemble the plate carrier.

1. Turn the power off and unplug the instrument.
2. Use disposable powder-free gloves.
3. If spillages have occurred, move the plate carrier by pushing it to the left (Figure 37). This makes it easier for you to clean the area under the plate carrier.
4. Wipe both the plate carrier and the area surrounding it with a mild detergent.
5. Clean the plate carrier immediately when spillages have occurred on or around the plate carrier. Be especially careful with the area close to the plate clamp!

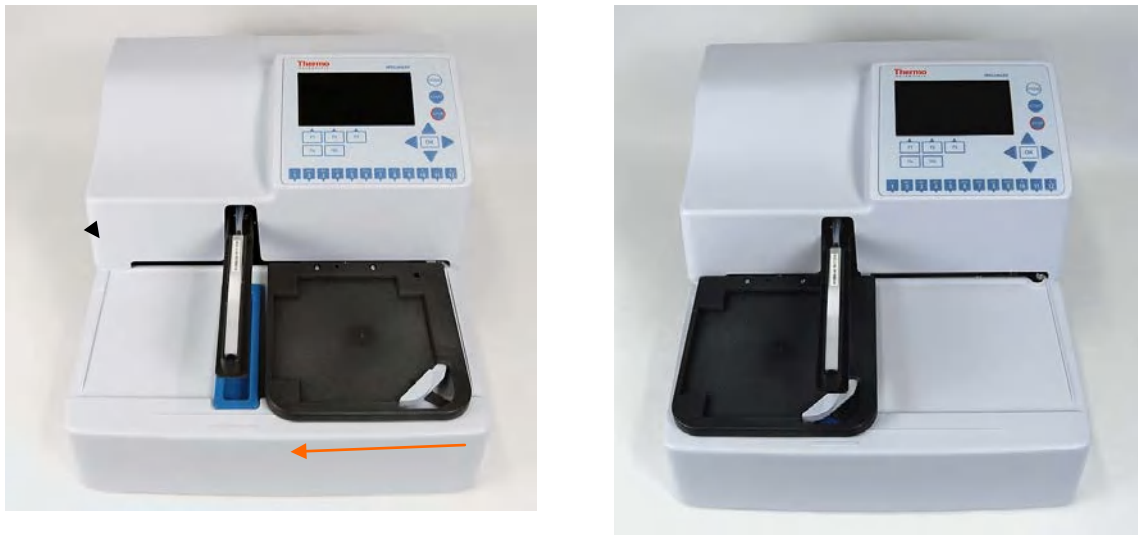

Figure 37. Cleaning the plate carrier and the surrounding area

6. Move the plate carrier back to its normal position once it has been cleaned.

Cleaning liquid bottles

Empty the waste bottle before cleaning it according to disposal regulations (see “Disposal of materials”).

The bottles must be cleaned regularly depending on the applications, using a mild detergent.

The liquid bottles, tubes and tube connectors can be autoclaved some five to ten times (Figure 38). The liquid level sensors or the liquid filters cannot be autoclaved (Figure 38).



Caution! Clean or replace the liquid filter of the intake tube regularly. For example, back flush the liquid filter with detergent or use an ultrasonicator.

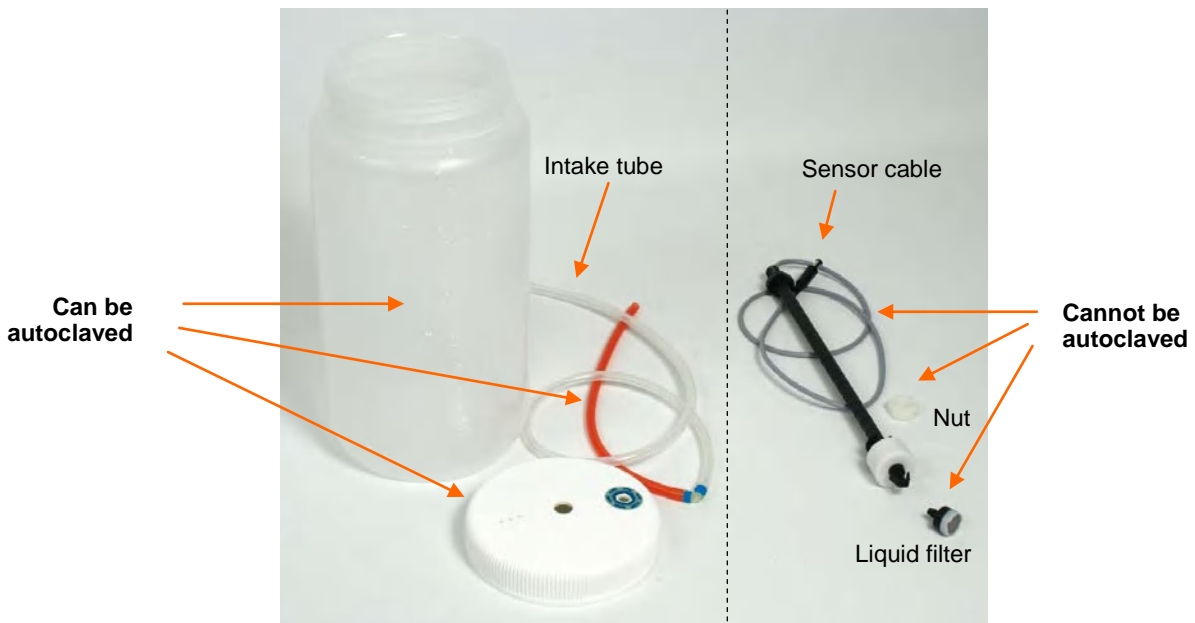

Figure 38. Autoclavable and un-autoclavable liquid bottle parts



Warning! When handling the waste bottle, it is advisable to observe applicable safety precautions, including the wearing of disposable powder-free gloves, safety glasses and protective clothing, to avoid potential infectious disease contamination.

Checking the liquid level sensors

Check the performance of the liquid level sensors as described in the “Liquid bottles and channels” and “Performing the operational check after switching on”.

Autoclavation

You may autoclave, that is, sterilize materials with pressurized steam. Autoclavable and un-autoclavable parts of the washer unit are listed in Table 8. Refer also to Figure 38.

The autoclaving conditions are as follows: at 121°C with 1 bar under pressure for 20 minutes.

Table 8. Autoclavable and not autoclavable parts of the washer

Autoclavable	Un-autoclavable
Liquid bottles	Aerosol cover
Liquid bottle caps	Liquid filter
Intake tubes	Liquid level sensor assemblies
Priming vessel	Sensor nut
Tube connectors	1x8 wash heads
	1x12 wash heads

Cleaning the wash head

To clean the wash head, refer to “Clean wash head”, “Soak wash head”, and/or “Move wash head” features in the **Maintenance** tab.



Warning! The wash head may be contaminated after the instrument has been used.



Warning! Disinfect the wash head thoroughly before you remove it.



Warning! Prime the instrument without liquid (with air) to empty all liquid from the system before removing the wash head.



Warning! When handling the waste bottle, it is advisable to observe applicable safety precautions, including the wearing of disposable powder-free gloves, safety glasses and protective clothing, to avoid potential infectious disease contamination.



Caution! Clean the wash head tips regularly. Wash head tips that are clogged can be cleaned using a declogging tool (Figure 39).



Figure 39. Declogging tool

Check that the wash head tips are in good condition and not deformed.

Mechanical cleaning of the wash head

- Detach the wash head from the tubing.
- Remove the wash head plugs and use the declogging tool to clean the tips.
- Rinse both channels with deionized distilled water using the syringe supplied with the instrument.
- Refit the wash head plugs.
- Attach the wash head to the instrument, prime the system and ensure that liquid comes out evenly from all tips.



Caution! Avoid breaking the smaller aspiration tube while detaching the wash head. If the tube breaks, replace with a new one. Do not use any other type of tubing.

Changing or replacing the wash head

If you change the wash head to another type, first change the wash head type in the **Settings** menu and then calibrate the wash head.

If you replace the wash head to the same type, calibrate the new wash head.

Refer to “Installing the wash head” and “Calibrate current wash head”.



Caution! Only use wash heads that have an identification label.

Checking the liquid line

Check the liquid line for possible leaks. Ensure that the silicone tubes are intact and there are no breaks or holes in them.

To ensure valve operation, first prime the system, then lift the buffer bottle about 20 cm and finally ensure that the tips are not dripping.

Checking the residual volume

Check the residual volume by dispensing 200 µl of 0.02% Tween™ solution over the whole plate. Aspirate and determine the residual volume by weighing the plate.

Make a protocol with dispense and aspirate step:

1. Dispense: 200 µl, Dispense height end: 17.
2. Aspirate: Aspirate mode: Sweep2, Aspirate height: 2.6mm, Aspirate speed: High, Aspirate time: 1s.

Tare weigh an empty plate using a laboratory balance. Select the whole plate and run the protocol. Weigh the plate again and determine the average residual volume per well in µl by dividing the mass in mg by 96.

Example: Residual liquid weight 91.2 mg. Residual volume/well [µl] = $91.2/96$ [µl] = 0.95 [µl]

Checking the dispense accuracy

Check the dispensing accuracy by dispensing one volume over the whole plate and determine the volume by weighing the plate.

Create a dispense protocol which dispenses 300 µl over the whole plate. Tare weigh an empty plate using a laboratory balance and dispense 0.02% Tween solution onto the plate. Weigh the plate again and determine the average volume dispensed per well in µl by dividing the mass in mg by 96.

Example: Dispensed liquid weight 28.608 g. Volume/well [µl] = $28608/96$ [µl] = 298 [µl]

Checking the aspirate height

Check the aspirate height by aspirating at the 0.0 mm level.

Make a protocol with an Aspirate step: Aspirate mode: Normal, Aspirate height: 0.0, Aspirate time: 10.

Disable the Plate sensor. Select the first column/strip and press **Start** without a plate. The wash head moves to the 0.0 mm level. Ensure that the wash head tips are on the plate bottom level of the plate carrier. Refer to Figure 34. Enable the Plate sensor after the test.

Manual priming

If both the Prime and Boost prime functions fail, you have to perform manual priming.

To prime a dry pump manually (Figure 40):

1. Fill the buffer bottle completely with liquid and close the cap. Place the bottle at the same level as the instrument.
2. Disconnect the liquid bottle tube from the tube fitting on the instrument.
3. Attach a 20 ml plastic syringe (Cat. No. N02942, supplied with the instrument) to the free end of the tube.
4. Gently aspirate liquid from the liquid bottle to fill the tube by “filling” the syringe. Leave a few centimeters of air at the end of the tube to prevent spilling.
5. Close (pinch) the tube, continue pinching the tube and then disconnect the tube from the syringe.
6. Reattach the tube to the fitting on the instrument side and release your grip.
7. Press the **PRIME** button on the instrument keypad and prime the channel.

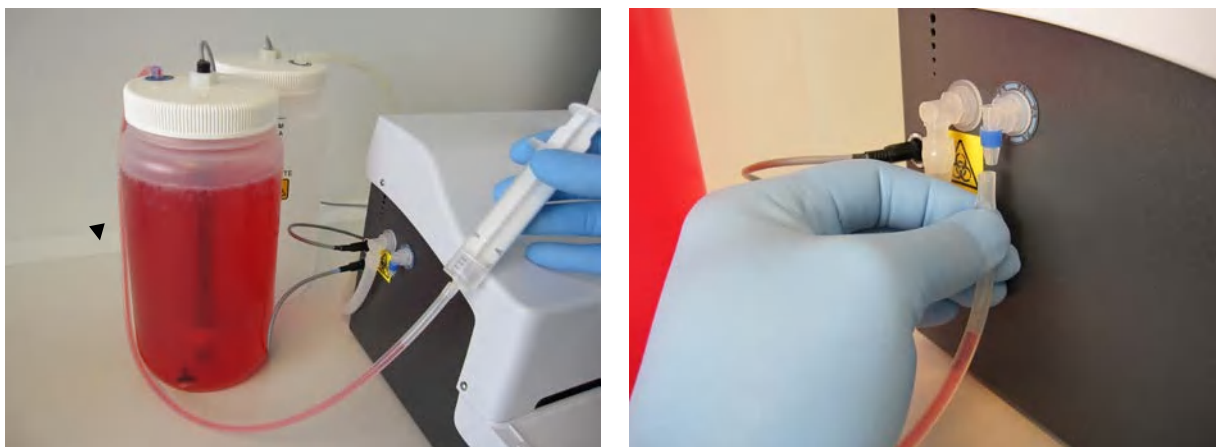

Figure 40. Manually priming a dry pump. Colored liquids are used for illustrative purposes.



Warning! Do not use boost priming if manual priming works as doing so may cause liquid spillage.

Disposal of materials

Follow laboratory and country-specific procedures for biohazardous or radioactive waste disposal. Refer to local regulations for the disposal of infectious material.



Warning! The samples can be potentially infectious. Dispose of all used plates, disposable gloves, syringes, disposable tips, and so on as biohazardous waste. Be cautious and always use disposable gloves.



Warning! Treat the used microplate, waste bottle, priming vessel on the plate carrier, disposables and all substances used in accordance with good laboratory practice (GLP) guidelines.



Warning! Inquire about appropriate collection points and approved methods of disposal in your country, state or region.

Decontamination procedure

If you have spilled infectious agents, carry out the decontamination procedure.



Warning! The decontamination procedure should be performed by authorized trained personnel in a well-ventilated room wearing disposable gloves, protective glasses and clothing.

Decontamination should be performed in accordance with normal laboratory procedures. Any decontamination instructions provided with the reagents used should be followed.

It is strongly recommended to perform the complete decontamination procedure before relocating the instrument from one laboratory to another.

Example of decontaminants:

- Ethanol 70%
- Virkon™ solution 1–3%
- Glutaraldehyde solution 4%
- Chloramine T
- Microcide SQ™ 1:64
- Decon™ 90 min. 4%



Caution! If local or laboratory regulations prescribe regular decontamination, it is not advisable to use formaldehyde, since even small traces of formaldehyde negatively affect the enzyme being used in EIA tests, resulting in inconsistent test results.

1. Prepare the decontaminant.
2. Run the Maintenance > **Cleaning/Disinfection procedure** using the prepared decontaminant. Refer to “Cleaning/Disinfection procedure”.
3. Autoclave the liquid bottles, tubes and liquid connectors if needed (Figure 38). However, the liquid level sensors or the liquid filters cannot be autoclaved (Figure 38).
4. Empty the plate carrier. Ensure that you are wearing disposable powder-free gloves.
5. Switch off the power and disconnect the power supply cable.
6. Disinfect the outside of the instrument using a cloth dampened with 70% ethanol.
7. Place the instrument in a large plastic bag.
8. Place a cloth soaked in the prepared decontaminant solution into the bag. Ensure that the cloth does not come into contact with the instrument.
9. Seal the bag firmly and leave the instrument in the bag for at least 24 hours.
10. Remove the instrument from the bag.
11. After decontamination, clean the instrument using a mild detergent.

12. After performing this decontamination procedure, enclose a signed and dated “*Certificate of Decontamination*” (see Appendix B) both inside the transport package and attached to the outside of the package.

Refitting the transport lock

When you relocate the instrument or ship it for service, make sure that you refit the transport lock.

1. Switch off the instrument.
2. Align the wash head arm and the plate carrier in order to refit the transport lock screw (Figure 41).

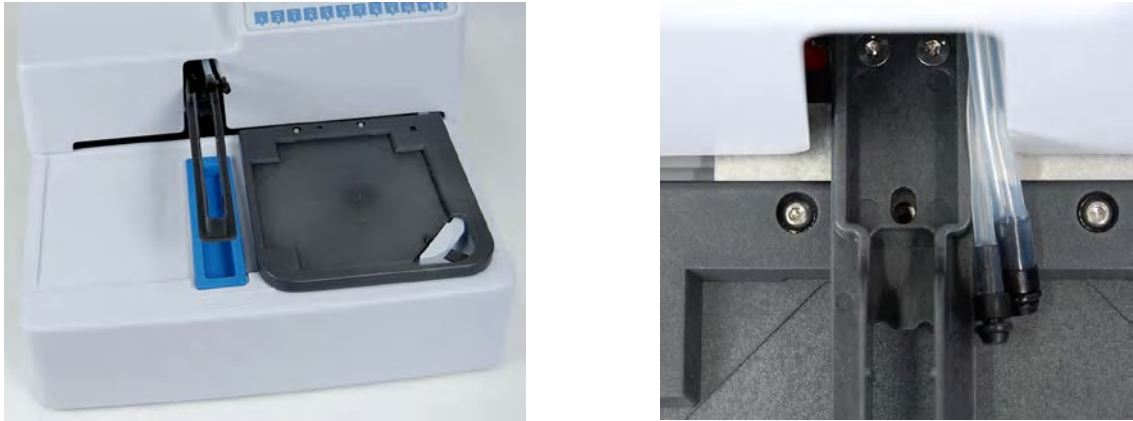

Figure 41. Aligning the plate carrier and wash head arm

3. Screw on the transport lock screw and the transport lock tag with the supplied Allen key (Figure 42).



Figure 42. Fastening the transport lock

4. Place small plastic bags around the tubes to protect them during transport.
5. Insert the padded packing material around the plate carrier and wash head arm for protection after the transport lock is refitted (Figure 43).



Figure 43. Transport lock and tag fitted

Maintaining a system log

A system log, which includes a short summary of the use, maintenance procedures, error messages and other information about the use of the system, aids proper maintenance of the system. Refer to Appendix A: "System Log".

Packing for service

To pack the Wellwash for service:

- Provide information about the use of hazardous materials.
- Prime the liquid channel of the instrument and clean the wash and waste bottles.
- Remove any microplate before decontamination. Decontaminate the instrument. Remove the liquid bottles and wash head.
- Refit the transport lock. Refer to "Refitting the transport lock".
- Use the original packaging for shipping.
- Pack the instrument according to the packing instructions.
- Enclose a dated and signed "*Certificate of Decontamination*" (see Appendix B) both inside and attached to the outside of the package, in which you return your instrument (or other items).
- Enclose the return authorization number (RGA) issued by your local Thermo Fisher Scientific representative.
- Specify the fault after you have been in touch with your local Thermo Fisher Scientific representative or the Thermo Fisher Scientific technical service department.

Disposal of the instrument

If the Wellwash is exposed to potentially infectious chemical samples, toxic or corrosive chemicals or radioactive chemicals, waste management of the complete instrument must be carried out to ensure that there is no risk of contamination.



Warning! Decontaminate the instrument before disposal. Refer to “Decontamination procedure”.



Caution! Observe all federal, state and local environmental regulations.

Follow laboratory and country-specific procedures for biohazardous or radioactive waste disposal.



Warning! The used lithium (Li) battery is regulated waste and must be disposed of according to local regulations. The Li battery has to be changed by an authorized service technician only. Instructions for changing the Li battery are described in the service manual.



Warning! Dispose of the instrument according to the legislation stipulated by the local authorities concerning take-back of electronic equipment and waste. The proposals for the procedures vary by country.

Pollution degree 2 (see “Safety specifications”)

Method of disposal Electronic waste
Contaminated waste
(Infectious waste)



Warning! Do not treat electrical and electronic equipment as unsorted waste. Collect waste from electrical and electronic equipment separately.

Regarding the original packaging and packing materials, use the recycling operators known to you.

For more information, contact your local Thermo Fisher Scientific representative.

Chapter 12: Technical Specifications

General specifications

Thermo Fisher Scientific reserves the right to change any specifications without prior notice as part of our continuous product development program (Table 9 and Table 10).

Table 9. General specifications

General specifications	
Overall dimensions	ca. 345 mm (W) x 385 mm (D) x 240 mm (H) [13.6" (W) x 15.2" (D) x 9.4" (H)]
Weight	8 kg [17.6 lbs.]
Operating conditions	+10°C to +40°C; maximum relative humidity 80% for temperatures up to 31°C decreasing linearly to 50% relative humidity at 40°C Indoor use only!
Transportation conditions	-40°C to +70°C, packed in transport packaging
Storage conditions	-25°C to +50°C, packed in transport packaging
Mains power supply	100–240 Vac, 50/60 Hz, nominal
Power consumption	80 VA max.
Heat dissipation	341 BTU max.
Noise	< 75 db (at a distance of 500 mm)
Display	High contrast color display with 480 x 272 dots
Keypad	Four arrow keys; OK button; three function keys F1-F3 ; FILE and HELP keys; 0-12 number keys; a-z letters, + - and space with the number keys; C key; START , STOP and PRIME buttons
User interface	Graphical user interface
Computer interface	USB 1.1 (2.0 compatible)
Plate types	96-well plates Maximum height 16.0 mm
Number of buffers	1 buffer

Performance specifications

This section provides the performance specifications at 18°C to 30°C and relative humidity 30% to 80% for the 1x8 and 1x12 wash heads.

Table 10. Performance specifications

Performance specifications	
Wash volume	50–1000 µl in 50 µl increments (96-well plate)
Wash cycles	1–10
Residual volume	< 2 µl per well in average over the plate with sweep aspirate mode and with high aspirate speed (flat-bottom 96-well plate)
Aspiration height	Adjustable, 0–14 mm in 0.1 mm increments
Dispense volume	50–400 µl in 50 µl increments (96-well plate)
Dispense accuracy	< 5% @ 300 µl
Dispense precision	< 3% (CV) @ 300 µl
Soak time	1 s – 60 min in increments of 1 s/min
Prime volume	5–100 ml in 5 ml increments
Memory	At least 100 protocols
Linear shaker	Amplitude 2.5 mm; 5 Hz Amplitude 1.5 mm; 10 Hz Amplitude 1 mm; 15 Hz

Safety specifications

In conformity with the requirements

Wellwash bears the following markings:
Type 888
100–240 Vac, 50/60 Hz, 80 VA max., Class I
CE marking
cTÜVus

The safety specifications are also met under the following environmental conditions in addition to or in excess of those stated in the operating conditions:	
Altitude	Up to 2000 m
Temperature	+5°C to +40°C
Humidity	Maximum relative humidity 80% for temperatures up to 31°C decreasing linearly to 50% relative humidity at 40°C
Mains supply fluctuations	±10% from nominal
Installation category (overvoltage category)	II according to IEC 60664-1 (see Note 1)
Pollution degree	2 according to IEC 60664-1 (see Note 2)



Note! 1) The installation category (overvoltage category) defines the level of transient overvoltage which the instrument is designed to withstand safely. It depends on the nature of the electricity supply and its overvoltage protection means. For example, in CAT II which is the category used for instruments in installations supplied from a supply comparable to public mains, such as hospital and research laboratories and most industrial laboratories, the expected transient overvoltage is 2500 V for a 230 V supply and 1500 V for a 120 V supply.



Note! 2) The pollution degree describes the amount of conductive pollution present in the operating environment. Pollution degree 2 assumes that normally only nonconductive pollution, such as dust, occurs with the exception of occasional conductivity caused by condensation.

Chapter 13: Troubleshooting Guide



Note! Do not use the instrument if it appears to be malfunctioning.

Error and warning codes

When an error is detected, the current operation is terminated. After an error, it is best to abort the current run and restart from the beginning after the problem is fixed. To abort, press the **STOP** button after an error and accept by pressing the **OK** button.

The error (Table 11) and warning codes (Table 12) are presented below.

Table 11. Error codes reported

Code	Explanation	Suggested action
2	Computer command not recognized.	Check the syntax.
3	Invalid computer command argument.	Check the syntax.
4	Plate position error.	Check the carrier movement. Contact authorized technical service.
5	Head position error.	Check the head movement. Contact authorized technical service.
6	Dispense pump rotation error.	Pump is jammed. Contact authorized technical service.
7	Dispense pump time out.	Pump is jammed. Contact authorized technical service.
8	Plate was not detected.	Insert the plate properly.
9	Plate sensor does not work.	Contact authorized technical service.
10	Non-volatile parameters lost.	Contact authorized technical service.
11	Attempt to reset the serial number.	–
12	No more memory for storing user data.	Memory is full, delete unused protocols.
13	Error(s) during startup.	Contact authorized technical service.
20	USBwiz error.	Contact authorized technical service.
21	No firmware on the USBwiz chip.	Contact authorized technical service.
22	XY offset adjustment failed.	–
23	More than one command has the same hash value.	–
25	Parameter memory not found.	Contact authorized technical service.
26	Parameter memory erase failure.	Contact authorized technical service.
27	Parameter memory write failure.	Contact authorized technical service.
50	File open error. File not found.	–
53	The file already exists.	Use a different file name.
54	The file does not exist.	–
55	The media is full.	Delete unused protocols.
56	End of file.	–
57	Other file error (none of the previous).	–
58	Firmware update aborted by user.	–
59	File read failed.	–
60	File not found.	–
61	USB memory stick not present.	Insert a USB memory stick.
62	File write failed.	–
70	Not enough memory.	Delete unused protocols.
71	Adding the step not successful.	–
80	Invalid step parameter(s).	–
81	Too many step parameters.	–
82	At least one of the step parameters is missing.	–
83	Step list is not empty.	–
84	Creating a new step list failed.	–
85	No strips are selected.	Select strips.
86	Invalid SOF parameter.	–
91	USB device timeout.	Try with another USB memory stick.

Table 12. Warning codes reported

Code	Explanation	Suggested action
101	WAI timer already timed out.	–
102	Liquid level alert.	Check the liquid levels in the bottles.

USB memory device

It is recommended to format the USB memory device if export or import fails.

It is recommended to use FAT16 or FAT32 formatted USB memory devices.

It is not recommended to use multiple drive USB memory devices that contain virtual CD drives.

The multiple drive USB memory devices normally contain one or more removable disk-type memory spaces, but can also contain virtual CD drive-type memory spaces. The Wellwash does not support virtual CD drive-type memory spaces.

It is possible to check if there is a virtual CD drive present when inserting a multiple drive USB memory device into the PC USB port.

1. Select **My Computer** and note the new drives that appear in the list when the multiple drive USB memory device is inserted.
2. Check all the appearing items by using the right-click mouse menu and selecting **Properties**.
3. The item type "Removable Disk" is stated for the USB memory device in the **General** sheet. It is compatible with the Wellwash if the File system is FAT16 or FAT32.
4. If the item is a virtual CD drive, then the type will be "CD Drive". This may cause the USB memory device to be incompatible with the Wellwash.

Troubleshooting guide

The problems covered below are considered faults that require repair or corrective work (Table 13). If problems occur or reoccur, contact authorized technical service immediately.

Table 13. Troubleshooting guide

Symptom	Cause	Suggested action
Dispensing volume is too low or residual volume too high.	Tubing is old or clogged. Wash head tips are blocked. Too high an aspiration position.	Use Maintenance > Clean > Soak wash head . Clean or replace the tubing. Clean the wash head tips with the declogging tool. Replace the wash head. Define the correct aspirate height.
Dispensing volume is too low.	Filter is blocked. The selector valve is not functioning properly.	Calibrate the wash head. Clean the liquid filters in the bottles. Component failure. Contact authorized technical service.
Volume is too low.	Tips are deformed. Leakage in tubing.	Change the wash head. Clean or replace the tubing.
Wrong volume is dispensed.	Dispensing valve is leaking when closed. Wash head is incorrectly aligned. Improper liquid calibration. Underpressure in the bottle. Too low maximum well volume has been defined. Pump characteristics have changed. Ambient temperature is too high or too low.	Component failure. Contact authorized technical service. Check that the wash head is properly fitted. Calibrate the wash head. Do not cover the venting holes in the liquid bottle caps. Check the step parameter and adjust it. Calibrate the dispensing pump speed. Component failure or wear. Contact authorized technical service. Check the ambient temperature.
Wrong volume is aspirated.	Aspiration tube is not connected to the wash head. Overpressure in the bottle.	Connect the aspiration tube to the wash head. Do not cover the venting holes in the bottle caps.

Symptom	Cause	Suggested action
	Pump characteristics have changed.	Contact authorized technical service.
	Wrong parameters are used.	Check the parameters.
Plate is processed incorrectly. Reagents are mixed.	A non-active valve is leaking.	Component failure. Contact authorized technical service.
Keys of the keypad do not function.	Keypad is broken.	Contact authorized technical service.
Display does not show all the information or anything at all.	Display is broken.	Contact authorized technical service.
Liquid is dispensed onto the plate carrier.	The plate orientation is incorrect.	Check the layout and place the plate in the correct orientation required by the wash head configuration.
	The installed wash head is incorrect.	Check the wash head and replace the correct wash head required by the layout and the protocol.
Liquid is spilled during operation.	Well volume or shake speed is too high.	Check the tubings and O-rings, and replace if needed. Decrease the well volume or shake speed.
Priming failed.	Tubings incorrectly installed. Tubings and/or liquid filters are clogged. Priming volume too low. Not enough buffer liquid. Instrument has not been used for a longer period. Liquid system completely dry or abnormal placement of liquid bottles.	Check the tubings. Clean or replace the tubings. Increase the priming volume. Fill the corresponding buffer bottle completely. Use the Maintenance > Service > Boost prime option. Move the liquid bottles to the instrument level. Perform manual priming; see "Manual priming".
Tips are dripping.	Air leak.	Check that the tubes and wash head plugs are properly fitted. Check that the tubings are intact. Apply silicone to the O-ring.
	Valve is leaking.	Contact authorized technical service.

Chapter 14: Ordering Information

Contact your local Thermo Fisher Scientific representative for ordering and service information (Table 14 and Table 15).

Wellwash

Table 14. Instrument catalog number

Code	Item
5165000	Wellwash 1x8 100–240V 50/60Hz
5165040	Wellwash 1x12 100–240V 50/60Hz

List of spare parts and accessories

Table 15. Codes for spare parts and accessories

Code	Item	Quantity
N15777	Wellwash User Manual, CD	1
N11165	Wellwash and Wellwash Versa Quick Reference Guide	1
N09541	Priming vessel	1
N10800	1x8 wash head	1
N10801	1x12 wash head	1
N10805	2 liter wash bottle, Wellwash (incl. cap with tubing and sensor)	1
N10806	2 liter waste bottle, Wellwash (incl. cap with tubing and sensor)	1
N10821	Spare bottle 2 l with solid cap	1
N10811	4 liter wash bottle A, round (incl. cap with tubing and sensor)	1
N10810	4 liter waste bottle, square (incl. cap with tubing and sensor)	1
N10822	Spare bottle 4 l, round with solid cap	
N10814	9 liter waste bottle, rectangular (incl. cap with tubing and sensor)	1
N10815	Aerosol cover, Wellwash	1
N10817	Bottle stand 1x2 configuration (2x2 l bottles), Wellwash	1
N10820	Bottle stand for own bottle	1
N12785	Spare cap for storage bottle, 2 pcs	1
N04001	USB A-B device cable 1.8 m *	1
N11116	Accessories Kit Incl. declogging tools normal/thin, syringe 20 ml, and silicon grease for O-rings	1
N12409	Wash head tubing connector Kit, 2 pcs each Incl. dispensing and aspiration tubing connectors (see Figure 44)	1
N12407	Liquid filter, 5 pcs	1
2305290	Serial cable F9/F25	1
SP-00245	PM Kit Wellwash (incl. bottle and wash head tubing, valve tubing, liquid filter, wash head plugs, O-rings, track slider, and cable ties)	1

* Longer USB cables available from PC stores



Figure 44. Wash head tubing connectors

Appendix B: Certificate of Decontamination

Name: _____

Address: _____

Tel./Fax: _____

Instrument: _____

Serial No.: _____

A) I confirm that the returned items have not been contaminated by body fluids, toxic, carcinogenic or radioactive materials or any other hazardous materials.

B) I confirm that the returned items have been decontaminated and can be handled without exposing the personnel to health hazards.

Materials used in the unit:

Chemicals +

Biological •

Radioactive *)

Specific information about contaminants: _____

Decontamination procedure¹: _____

Date and place: _____

Signature: _____

Name (block capitals): _____

*) The signature of a Radiation Safety Officer is also required when the unit has been used with radioactive materials.

This unit is certified by the undersigned to be free of radioactive contamination.

Date and place: _____

Signature: _____

Name (block capitals): _____

¹ Please include decontaminating solution used.

Glossary

decontamination	Removal or neutralization of radiologic, bacteriological, chemical or other contamination.
disinfection	The destruction of pathogenic bacteria, usually with an antiseptic chemical or disinfectant.
EIA	Enzyme immunoassay. An immunoassay using a color-changing enzyme-substrate system for indicating results. A diagnostic test method to measure or detect a substance using antibody-antigen reactions.
ELISA	Abbreviation for enzyme-linked immunosorbent assay.
remote control	Running mode allowing a remote computer to operate the washer.
wash head	Interchangeable heads allowing either 1x8 or 1x12 processing.
USB	Universal serial bus.