



Linkam Scientific Instruments

FDCS196 / THMS350V

Vacuum Stage

USER GUIDE

Contents

Stages covered by this manual	3
Before Setting Up Your Equipment.....	3
Important Notice	4
Warranty.....	4
Technical Support.....	4
Equipment Maintenance.....	4
Handling Liquid Nitrogen.....	4
Safety Precautions.....	5
Symbol Reference.....	5
Introduction.....	6
FDCS196 Stage Specification	6
FDCS196 System	6
Stage Anatomy.....	7
Mounting Stage to Microscope with Dovetail Substage	8
Setting up the Condenser for Koehler Illumination	8
Vacuum Tweezers	9
Connecting the Pirani Gauge	10
Flexible Stainless Steel Vacuum Tube Connection	11
FDCS196 Pro System Setup.....	12
Vacuum Pump Setup.....	12
MV196 Motorised Valve System Setup.....	12
Mounting the MV196.....	12
Sample Preparation and Loading	13
Sample Loading Using G16.3 Sample Holder.....	13
Sample Loading Using FDCS196/CC Crucible Carrier and Quartz Crucible	16
Cooling Connections	19
Filling the Liquid Nitrogen Dewar	19
Appendix.....	20
Using The Stage with Gas Connectors.....	20
Installing Gas Connectors.....	20
Window Assembly.....	21
Lid Window Assembly	21
Bottom Window Assembly	21
Troubleshooting	22
Alternative Configuration: THMS350V	23
THMS350V Stage Anatomy.....	24
Alternative Configuration: THMSEL350V.....	25
THMSEL350V Stage Anatomy	26
Using the Ellipsometer stage with vacuum port.....	27
Ellipsometer windows assembly	28
Contact Details	32

Stages covered by this manual

The following Linkam stages are covered in this manual:

FDCS196 Freeze drying cryo stage.

THMS350V High temperature vacuum stage

THMSEL350V High temperature vacuum stage with ellipsometry

Before Setting Up Your Equipment

Please register your products by going to the technical support section of our web site www.linkam.co.uk

You will need to register your equipment with us to:

- Activate your warranty and technical support
- Access the online setup videos
- Permanently unlock LINK software (if purchased)

If you have purchased LINK software, or want to try a demonstration of it, please install it first. You will be guided through the LINK software registration process the first time that the software is used, and will need the LINK software registration card to complete this.

Important Notice

Please check that your Linkam equipment has not been damaged during transit. If there is any evidence of external damage **DO NOT SWITCH ON ANY ELECTRICAL ITEMS.**

Contact LINKAM SCIENTIFIC or their appointed distributor immediately. Your warranty may be impaired if Linkam is not informed of any transport damage within 7 working days of delivery.

NO attempt should be made to repair or modify the equipment in any way, as there are **no user replaceable parts.**

No attempt should be made to open the case except by qualified personnel as hazardous voltages are present.

In order to use this equipment successfully, please take time to read this manual all the way through before using it.

Warranty

This equipment has a warranty against defects in material and workmanship for a period of 12 months. Linkam will either repair or replace products that prove to be defective. For warranty service or repair, this product must be returned to Linkam or a designated service facility.

The warranty shall not apply to defects resulting from interfacing, unauthorized modification or misuse, operation outside of the environmental specifications for the product, or improper site preparation or maintenance.

Technical Support

Any technical questions or queries should be addressed to the Technical Support Department at the address shown on the back of this manual.

Equipment Maintenance

Use a small quantity of isopropyl alcohol with a soft cloth and gently wipe the surface. To clean the hotstage, use isopropyl alcohol (IPA) and cotton swabs. Take great care not to touch the platinum temperature sensor protruding from the side of the heating element. The sensor is very fragile.

Handling Liquid Nitrogen

To cool samples below room temperature a LNP95 liquid nitrogen pump is required. Please refer to your health and safety manual for instructions on how to handle liquid nitrogen safely. Always use in a well ventilated room.

Safety Precautions

- 1) Read this guide before using the equipment. Save these instructions for later use.
- 2) Follow all warnings and instructions which may be placed on the stage.
- 3) Never use the equipment if any cables have been damaged. Do not allow any heavy objects to rest on the cables. Never lay the cables on the floor.
- 4) Do not obstruct any ventilation holes. Do not attempt to insert anything into these openings. Provide adequate ventilation of at least 75mm all around the equipment.
- 5) Do not expose the equipment to water. If for any reason it gets wet then unplug it from the mains and contact Linkam Scientific Technical Support.
- 6) The equipment is not intended to be used outdoors.
- 7) If any problems occur then turn all Linkam equipment off and contact Linkam Scientific Technical Support.
- 8) Do not remove any covers from the equipment, any servicing should be carried out by qualified service personnel.

Symbol References

Caution:



This warning symbol indicates that the surface labelled with this symbol may be hot.

Introduction

Thank you for purchasing the FDCS196 Freeze Drying Stage system. Please take the time to read through the manual as it will help you to make the most out of the equipment.

FDCS196 Stage Specifications

Objective Lens WD:	4.6mm
Condenser lens WD:	12.5mm
Objective light approach angle:	115°
Maximum temperature:	125°C
Minimum temperature:	-196 °C
Maximum heating rate:	150°C/min
Maximum cooling rate:	60°C/min
Maximum cooling Rate under vacuum:	130°C/min
Maximum vacuum:	10 ⁻³ mBar
XY-Manipulators travel:	16mm
Vacuum flange type:	KF10 / KF10
Aperture hole:	1.3mm
Weight:	0.6Kg



FDCS196 System

FDCS196 System

The system consists of a FDCS196 stage, a T95-LinkPad System Controller, LNP95 liquid nitrogen cooling pump system, Pirani vacuum gauge and LINK software.

The FDCS196 Pro System has an additional 1.5L Vacuum Pump and MV196 motorised vacuum valve control System.

LINK System control software and digital video capture can be added as an option to control from PC.

The FDCS196 stage is mounted onto the microscope by using specific stage clamps or an adaptor plate.

This manual will describe instruction for setting up a standard FDCS196 System.

Stage Anatomy

1. Lemo connector for Stage Connection Lead
2. Heating element carrier assembly
3. Platinum temperature sensor
4. 22mm Diameter heating block
5. Sample chamber
6. X-Sample manipulator
7. Door locking thumbscrew
8. Liquid nitrogen cooling connector
9. Heating element wire
10. Stainless steel cooling tube
11. Vacuum port
12. Sample holder ramp
13. Y-Sample manipulator
14. Stage lid
15. Lid insert
16. Quartz window (0.5mm thick)
17. Tube Clip Holder and tubing for Nitrogen de-fogging stage window

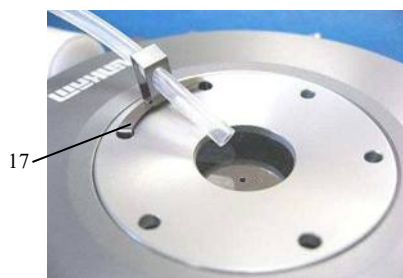
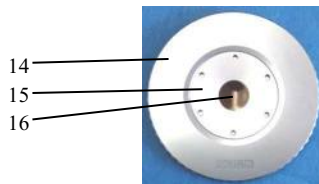
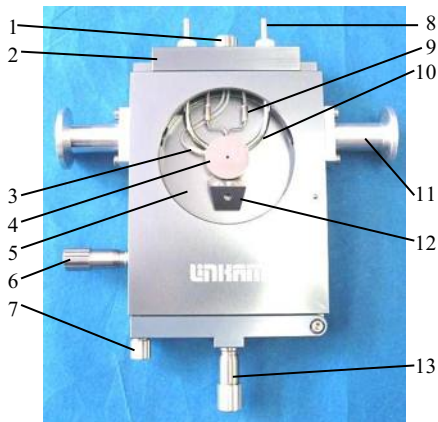

Mounting Stage to Microscope with Dovetail Substage

The following description is for mounting the stage on to microscopes which have a circular dovetail substage assembly.

Attach the curved stage clamps (part no. 9542) to the base of the stage using the supplied hex screws and the outer most holes in the base plate.

Adjust the two positioning screws so that approximately 5mm of thread is exposed on the inside edge of the clamp. This will roughly position the stage in the centre of the dovetail.

Place the stage onto the dovetail then focus a 10X objective lens on the aperture of the silver block. Using the two positioning screws ensure that the aperture is in the centre of the field of view.

For other types microscope's substage, see the included diagram for fitting instruction.

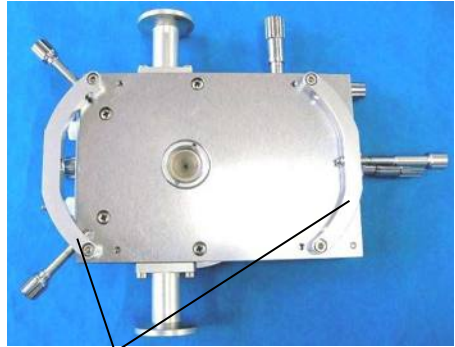

9542 curve clamps set



Dovetail substage

Setting up the Condenser for Koehler Illumination.

Place a small sample on a cover slip and place onto the surface of the silver block. Use the 10X lens to focus on the sample. Now close down the microscope field diaphragm and adjust the condenser focus so that the edges of the diaphragm are in focus. Now use the condenser positioning screws to centre the condenser in your field of view. Open the diaphragm so that it just fills the field of view.

For more information about Koehler illumination see the extremely informative 'microscopy Primer' on the Molecular Expressions website.

<http://micro.magnet.fsu.edu/primer/index.html>



Vacuum Tweezers

The vacuum tweezers are used to manipulate the glass sample slides onto the silver block to prevent fingerprints on the glass and scratching the surface of the silver block when using standard fine tip metal tweezers.

The System is supplied with a Vacuum Tweezers Kit which consists of a Vacuum Pump (1) and tweezers (2).

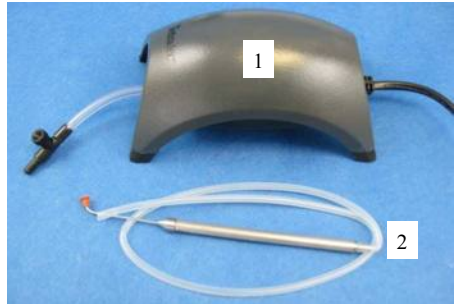

Connect the tubing at the end of the tweezers to the Regulator Valve (3) connection.

Use the dial on the valve to adjust the vacuum for the tweezers.

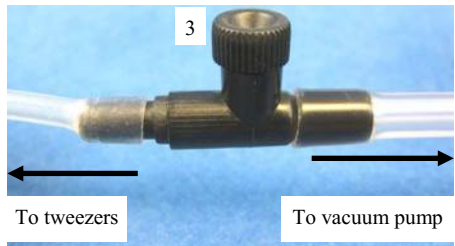

Use a finger to block the hole of the tweezers to pick up a sample cover slip with the suction cup.



Release the finger to drop the sample cover slip.

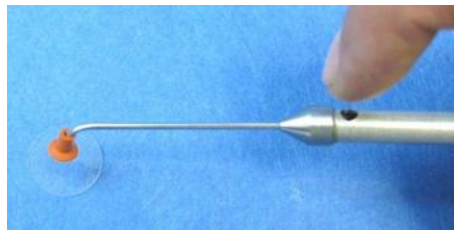

Connecting the Pirani Gauge

The surfaces where the O-ring (1) sits should be completely free of dirt. The O-rings should be smeared with a small amount of vacuum grease before loading in between the Pirani Gauge (2) and the Stage Vacuum Connector (3).

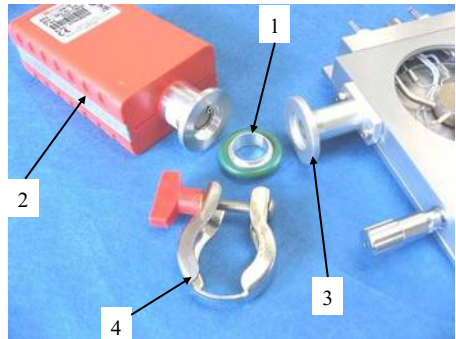

Ensure that the O-ring is correctly seated in the gauge and vacuum connector before tightening the Clamping Bracket (4) screw (5).

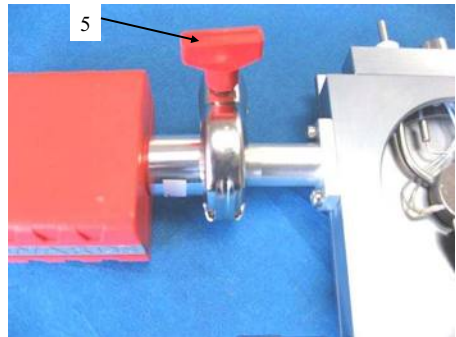

Connect the Pirani Cable with the LAN type connector (5) to the Pirani and the other end of the cable to the back of the T95; Slot 4; labelled 'VAC', see page 9.

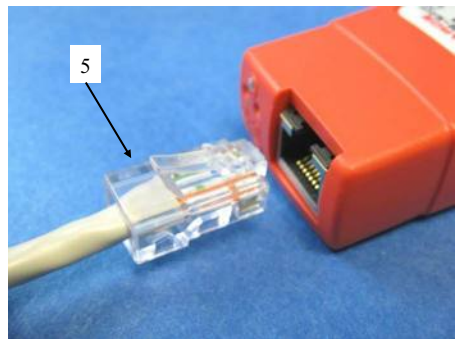

Flexible Stainless Steel Vacuum Tube Connection

The surfaces where the O-ring (1) sits should be completely free of dirt. The O-rings should be smeared with a small amount of vacuum grease before loading in between the Flexible Stainless Steel Vacuum Tube (2) and the stage Vacuum Connector (3).

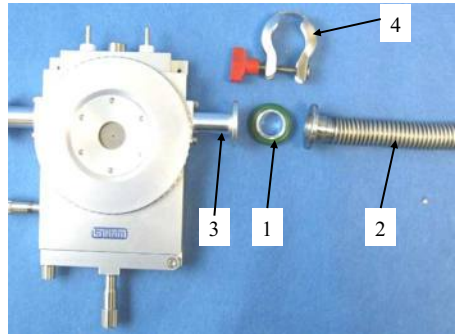

Ensure that the O-ring is correctly seated in the Steel Vacuum Tube and vacuum connector before tightening the Clamping Bracket (4) screw (5).

Connect the other end of the Flexible Stainless Steel Vacuum Tube to a Vacuum Pump.

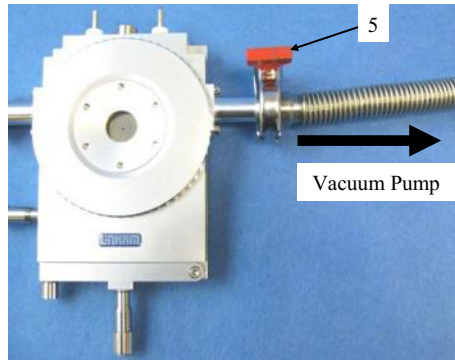

Note: the FDSC196 is tested with a vacuum of 10^{-3} mBar. Do not use a vacuum lower than this.

FDSC196 Pro System Setup

Only read the following section if you have purchased the FDSC196 Pro System.

Vacuum Pump Setup

Please refer to the Vacuum Pump manual to fill the pump with oil and to install the mist filter (1).

MV196 Motorised Valve System Setup

The MV196 Motorized Vacuum Control System consists of a motorized valve (2) connected to a T-piece (3) on top of the Vacuum Pump (4).

Please note that the motorized valve accurately controls the vacuum within the stage but the maximum vacuum possible is not as great as when using a simple on/off style valve.

Mounting the MV196

The MV196 has a vacuum flange just like the vacuum ports on the sides of the FDSC196 Stage. Use a small amount of vacuum grease to coat a thin layer on the surface where the O-ring will sit. Coat the surfaces of the T-piece with vacuum grease as well. The valve has two ports, there is one in line and one protruding perpendicularly out of the side of this valve. The side port (5) is for the controlled vacuum vent and therefore should not have anything attached to it.

Use the Clamping Bracket (6) to secure the T-piece to the port as seen in the opposite picture. Secure the vacuum pipe between the stage and T-piece using the supplied O-rings and clamping rings (6).

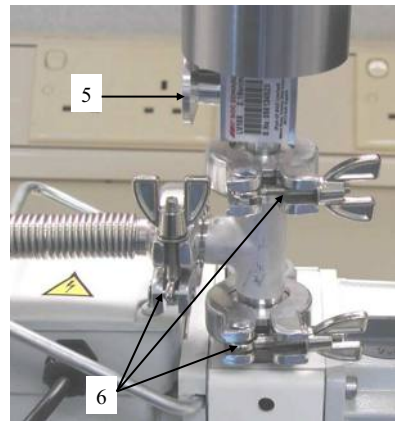
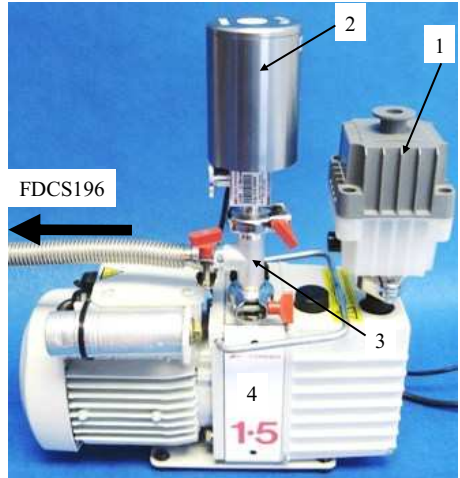

Sample Preparation and Loading

The stage chamber must first be prepared for vacuum. Ensure that the chamber is completely clean and dry inside. Finger grease and dirt must be cleaned off with IPA (isopropanol).

Sample Loading Using G16.3 Sample Holder

A Freeze Drying Sample is prepared using a G16.3 Sample Holder (1).

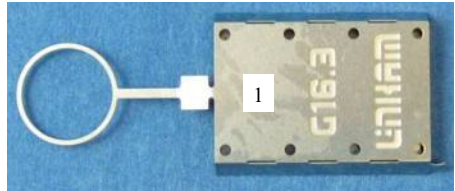

To load the G16.3 into the FDCS stage, open the door of the stage by unscrewing the door thumbscrew. The G16.3 slides into the brass housing located just inside the door.

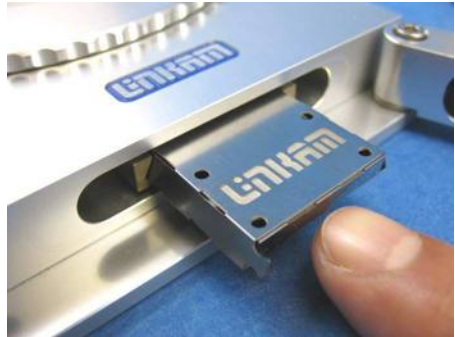

The Sample Holder Ramp (2) will guide the G16.3 up on to the silver block.

Close the door and tighten the thumbscrew to seal the stage.

Adjust the XY manipulators so the holder is in the middle of the silver block

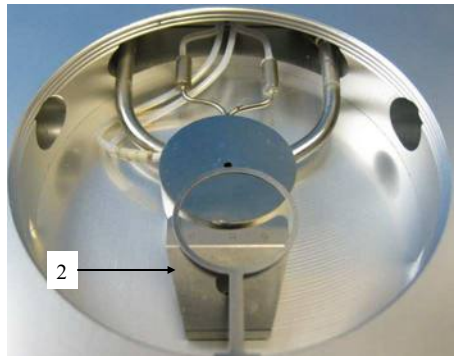

At standard atmospheric pressure the contact between the sample and the silver block is enough to establish good thermal contact as the air molecules in any minute scratches will conduct the heat, but when pulling a vacuum these are drawn out of the stage. Objective immersion oil (supplied) has the same refractive index as quartz and ensures an almost perfect thermal seal between block and crucible.

Using either the dropper or micropipette place a tiny drop of oil on the silver block. Be careful not to place the oil over the aperture hole of the silver block.

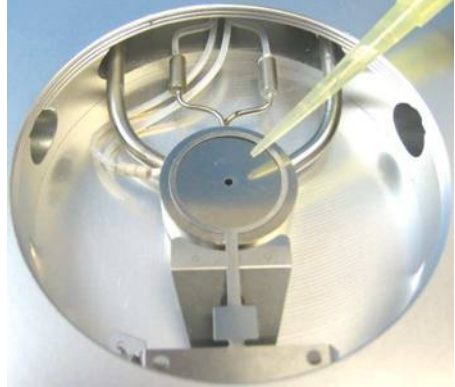

Use the supplied Vacuum Tweezers or a pair of tweezers place a clean 16 x 0.3mm Quartz Sample Window directly on top of the oil inside the G16.3 Sampler Holder.

Adjust the XY manipulators by a few turns in both directions to spread out the oil underneath the Quartz Sample Window evenly.



Using a pair of tweezers place a Shim Spacer (1) in the middle of the Sample Holder.

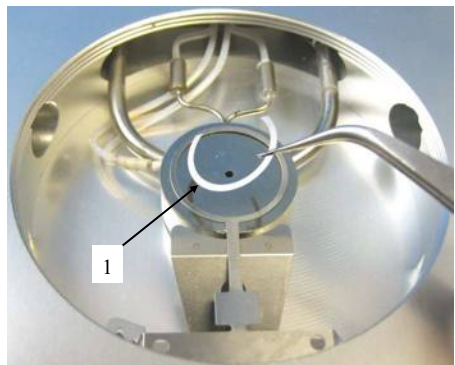

Pipette 2 μ l of sample on the Quartz Sample Window inside the Shim Spacer.

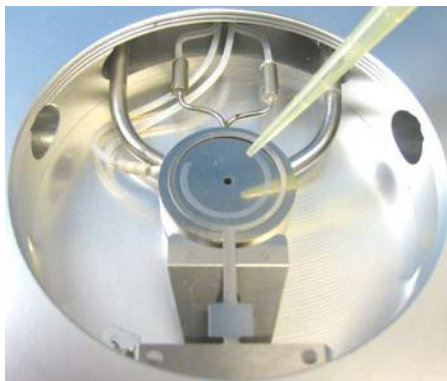

Use the supplied Vacuum Tweezers or a pair of tweezers place a clean W13G, (13 x 0.17mm) Glass Sample Window on top of the sample, ensuring it touches the Shim Spacer.

Use the XY manipulators to move the Sample Holder so the edge of the sample sits across the aperture hole of the silver block. This makes visual location of the sample easier once analysis starts.



Sample Loading Using FDCS/CC Crucible Carrier and Quartz Crucible

This method is used if you are preparing the sample away from the FDCS196 stage.

The crucible carrier has two spring clips to hold the crucible flat against the silver block. This is to ensure good thermal contact.



To load the quartz crucible into the carrier, lift the two spring clips about 2mm upward and slide the crucible in to the holder.

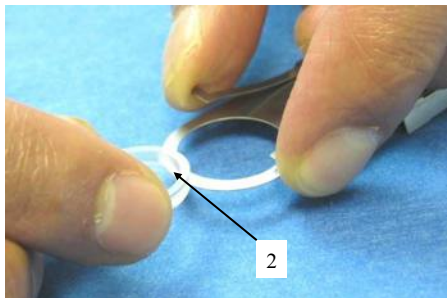

Release the two spring clips to hold the Crucible in place.



Use a pair of tweezers to place a Shim Spacer inside the Quartz Crucible.

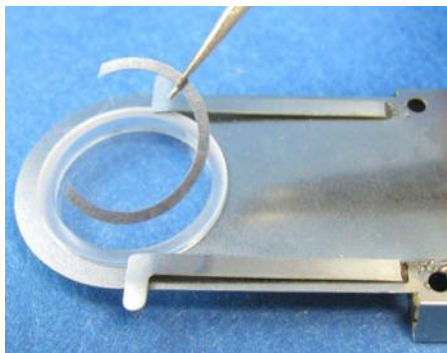

Pipette 2 μ l of sample inside the Shim Spacer.

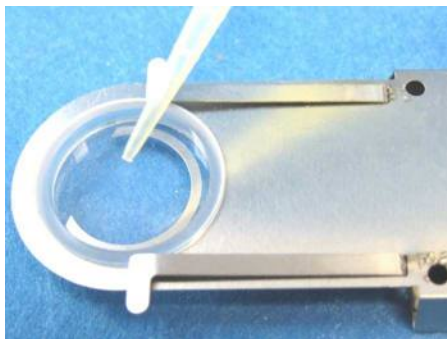

Use the supplied Vacuum Tweezers or a pair of tweezers to place a clean W13G, (13 x 0.17mm) Glass Sample Window on top of the sample, ensure it touches the Shim Spacer.

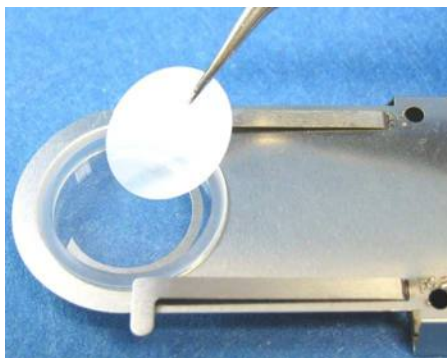

Before loading the Crucible Carrier the silver block must be prepared with silicon oil to provide a good thermal contact between the crucible and the silver block when the stage is under a vacuum.

Using either the dropper or micropipette place a tiny drop of oil on the silver block. Be careful not to place the oil over the aperture hole of the silver block.

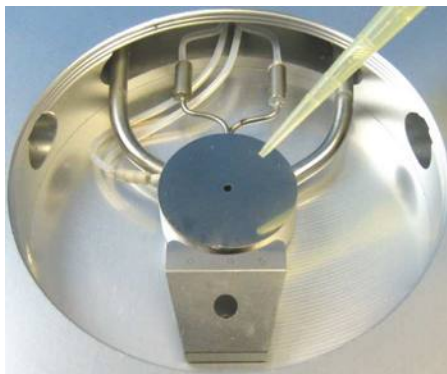

Load the Crucible Holder with the prepared sample into the FDSC196 stage. Unscrew the Y manipulator (the one screwed into the stage door) so that when you close the door, the FDSC/CC doesn't push the crucible right off the edge of the block and the silicon oil with it.

Open the door of the stage by unscrewing the door thumbscrew. The FDSC/CC slides into the brass housing located just inside the door. There is a Sample Holder Ramp just before the silver block which guides the crucible up on to the block.



With one hand push the FDSC/CC and with the other hand lift the edge of the crucible up the ramp and over the drop of oil. When the drop of oil is roughly in the centre of the crucible gently lower the crucible on the block. Now close the door of the stage and screw in the door locking screw. This screw only needs to be finger tight.

Adjust the XY manipulators by a few turns in both directions to spread out the oil underneath the Quartz Crucible.

Use the XY manipulators to move the FDSC/CC so the edge of the sample sits across the aperture hole of the silver block. This makes visual location of the sample easier once analysis starts.

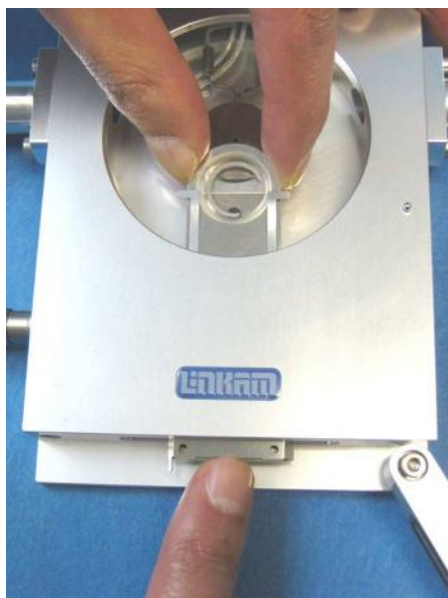

Cooling Connections

These connections need only be made if the experiments are to be carried out below room temperature.

The Dewar Siphon (1) is the thick white foam tubing and is attached to the liquid nitrogen Dewar. The thin black capillary tube inside the white foam tube must be inserted into the liquid nitrogen cooling connectors on the stage.

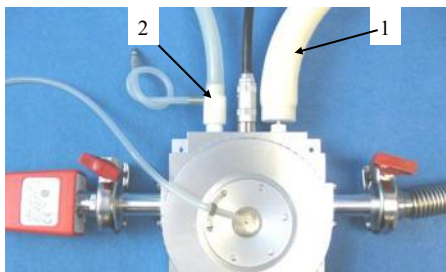

The white tubing slides on to the outside of the connector. Twist the siphon whilst sliding it on and push until it comes to a stop. It does not need to go all the way to the base of the connector.

The thicker silicon tube from the LNP95 cooling pump ends in a white PTFE connector (2), this is pushed over the end of the other stainless steel connector as seen in the image.

The smaller tube from the outlet on the LNP95 should be placed in position on the top of the lid using the Tube Clip Holder (3). This tube blows warm recycled nitrogen gas across the lid window to prevent condensation on the viewing window surface.

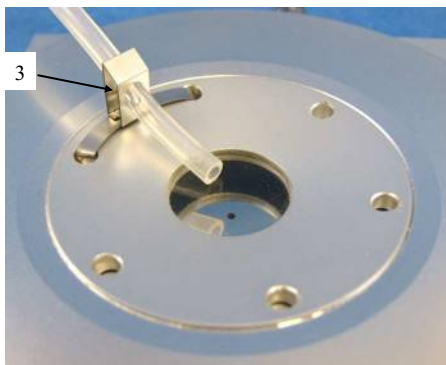

Filling the Liquid Nitrogen Dewar

Please follow your health and safety manual for directions on how to handle liquid nitrogen and ensure that you have the correct safety equipment including gloves and safety goggles.

Fill the Dewar until approximately 2/3 full and replace the lid with siphon attached.

DO NOT FASTEN THE CATCHES.

Wait for the nitrogen to stop bubbling before fastening the catches.

Take care when placing lid on a table to always have the black capillary pointing upwards. It is easily damaged which will impair N₂ flow.

Appendix

Using The Stage With Gas Connectors

Installing Gas Connectors

This is used when vacuum is not needed.

To replace the vacuum port with a gas port connector (1), use the hex key provided to remove the two screws that hold the vacuum port in place.

Do the reverse to fit in the gas port connector and make sure that the vacuum/gas seal (2) insert is placed between the stage and connector.

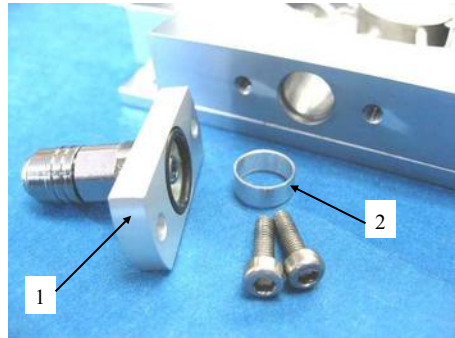

The Gas Connector is self closing, it is open when the Gas Insert is pushed into the Gas Connector.

To close the connector, the Gas Insert is removed.

To use the Gas Insert, connect one end to a tube (3mm inner diameter, 6mm outer diameter) and push the other end into the Gas Connector. You should hear a “click” when the two parts are connected properly.

To remove the Gas Insert, just push back the outer sleeve of the Gas connector toward the base of the FDCS196 Stage and the Gas Insert should drop out.

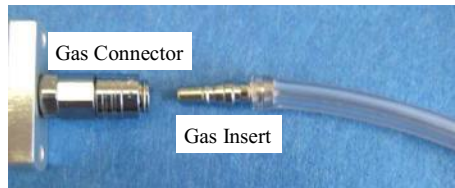

Window Assembly

Lid Window Assembly

To replace the windows in the Stage Lid (1) use the Window Tool (2) and align the two wide spacing pins to the Tube Clip Holder holes and unscrew the Lid Insert (3).

The Stage Lid and Lid Insert should be turned upside down as shown in the diagram opposite and reassembled in the order indicated.

The Lid Insert should be screwed down until the cover slips are held firmly, then turn the assembly over and screw down the Lid Insert until it is felt to come to a stop.

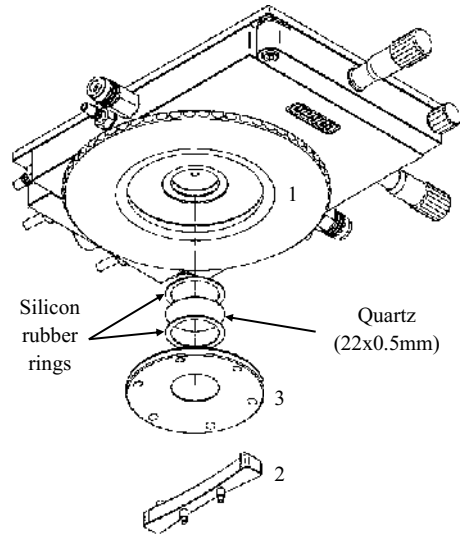

Bottom Window Assembly

Use two narrow spacing pins of Window Tool (2) to align it to the two holes of Window Locking Ring (4) and unscrew.

Reassemble the bottom window as shown in the opposite diagram

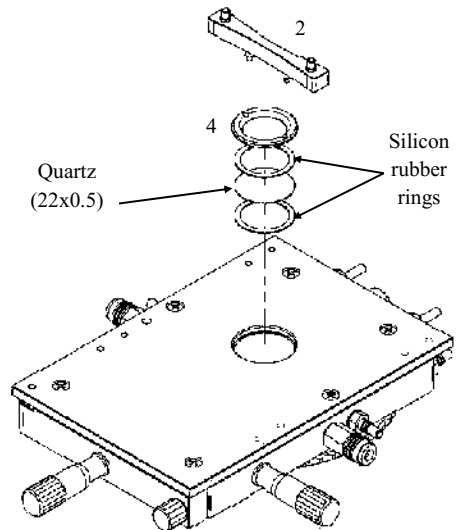

Troubleshooting

Cooling fault diagnosis

Ensure that all connections to the stage and Dewar are as described in the specific manual and that the stage lid and top windows are properly sealed.

1. *The cooling rate is less than programmed.*

There can be several causes of this problem, the most likely being that one of the connectors has become blocked or damaged. Check that each tube is fitted tightly to the connector and that none of the tubing is twisted or has come loose. The larger diameter tube leading from the LNP95 consists of a tube within a tube, check that the internal tube is connected, it may have come loose. Any constrictions of either the tubing or the connector will have a drastic effect on the cooling ability of the LNP95. If the connectors and tubing are OK, check that the capillary tubing to the Dewar flask is not bent or damaged and that the filter is intact and unblocked. If any damage has occurred to any of these items then it will be necessary to replace them. If no damage is found, check that the silver block is not constricted. This can be checked, simply by blowing through one of the steel cooling tubes using a compressed air line.

2. *Stage will not cool down to -196°C .*

Check that the stage lid is not touching the silver block when screwed down. Check that the silver block has not been pushed down so that it touches the base of the stage. Check the sample holder ramp is not touching the silver block. Any of these faults will cause a substantial loss of cooling ability.

3. *Condensation and ice forming on the upper side of window*

Realign the window gas tube clip to the required position in the stage lid.

4. *Condensation on the sample and/or the underside of lid window*

This is due to the stage not being sealed properly and therefore allowing moisture in during purging or cooling. Check that the lid and bottom window are sealed correctly and that the silicon seals are in position.

Please visit www.Linkam.co.uk for more FAQ for the stage and instruments.

Alternative configuration: THMS350V

Thank you for purchasing the THMS350V temperature controlled vacuum system. Please take the time to read through the manual as it will help you to make the most out of the equipment.

THMS350V Stage Specifications

Objective Lens WD:	4.6mm
Condenser lens WD:	12.5mm
Objective light approach angle:	115°
Condenser light approach angle:	60°
Maximum temperature:	350°C
Minimum temperature:	-196°C
Maximum heating rate:	30°C/min
Maximum vacuum:	10 ⁻³ mBar
XY-Manipulators travel:	16mm
Vacuum flange type:	FK10/FK16 or NW16
Aperture hole:	1.3mm
Weight:	0.7Kg



Examina Vacuum Hotstage System
With LNP95

THMS350V Systems

There are two systems:

1. Examina Vacuum Hotstage System: consists of a THMS350V stage, a T95-LinkPad System Controller, Pirani vacuum gauge and LINK software.
2. Examina Vacuum Hotstage Pro System: consists of the above parts but has an additional Vacuum Pump and MV196 motorised vacuum valve control System.

An LNP95 Liquid Nitrogen Pump System can be added to cool the stage to -196°C .

This manual will describe instructions for setting up a standard THMS350V System.

THMS350V Stage Anatomy

Stage Assembly

1. Lemo connector for Stage Connection Lead
2. Heating element carrier assembly
3. Platinum temperature sensor
4. 22mm Diameter copper heating block (nickel plated)
5. Sample chamber
6. X-Sample manipulator
7. Door locking thumbscrew
8. Liquid nitrogen cooling connector
9. Heating element wire
10. Stainless steel cooling tube
11. Vacuum port
12. Sample holder ramp
13. Y-Sample manipulator

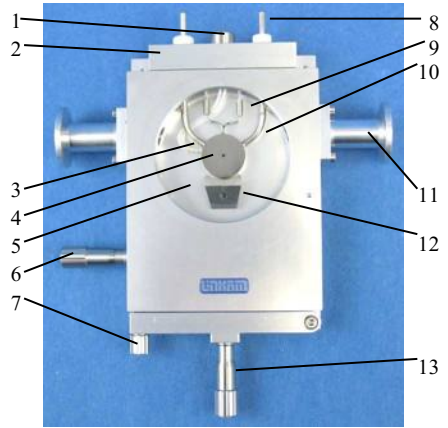

Lid Assembly

14. Stage lid
15. Lid insert
16. Glass window (0.3mm thick)

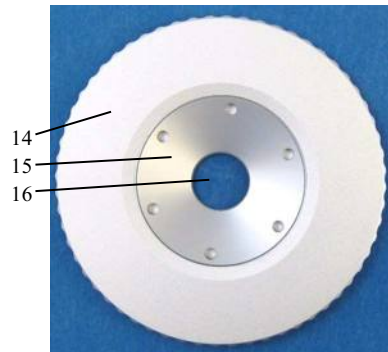

17. Tube Clip Holder and tubing for Nitrogen de-fogging stage window

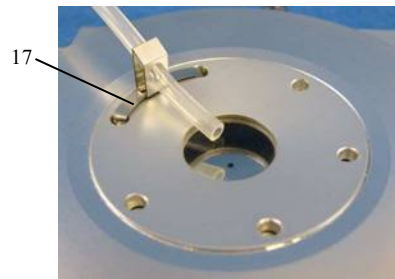

Alternative configuration: THMSEL350V

Thank you for purchasing the THMSEL350V Stage. Please take the time to read through the manual as it will help you to get the most out of the equipment.

For work below ambient temperature vacuum must be used to reduce condensation inside the stage and on sample.

THMSEL350V Stage Specifications

Ellipsometer Side Windows
light approach angle: 140° overall
Minimum temperature: -196°C
Maximum temperature: 350°C
Maximum heating rate: 30°C/min

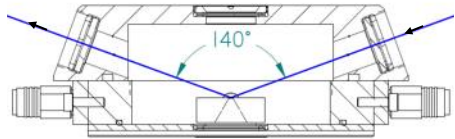

THMSEL350V System

The standard system consists of an THMSEL350V Stage, a T95-LinkPad System Controller and LNP95 Liquid Nitrogen Cooling System.

LINK System control software and digital video capture can be added as an option to control from PC.

Optional Pirani Gauge, MV196 Motorised Vacuum Control System and a Vacuum Pump can be added to upgrade the system.

The top and bottom windows have a 22mm glass window fitted and the side windows of the Ellipsometer lid has a choice of quartz or ZnSe windows as ordered with the stage.



Window Options

- Quartz 18mm x 5.0mm thick (spectroscopy grade)
- Quartz 18mm x 2.0mm thick
- Quartz 18mm x 0.5mm thick
- ZnSe 18mm x 2.0mm thick

THMSEL350V Stage Anatomy

Stage Assembly

1. Lemo connector for Stage Connection Lead
2. Heating element carrier assembly
3. Platinum temperature sensor
4. 22mm copper nickel plated block
5. Sample chamber
6. X-Sample manipulator
7. Door locking thumbscrew
8. Liquid nitrogen cooling connector
9. Heating element wire
10. Stainless steel cooling tube
11. Gas / vacuum port (gas port shown)
12. Sample holder ramp
13. Y-Sample manipulator

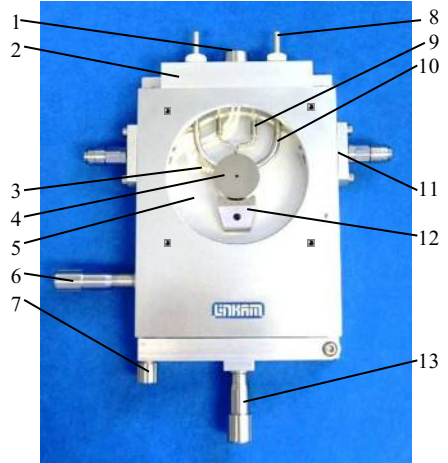

Lid Assembly

The Lid is (15) removed from the stage by unscrewing the 4x Clamp screw (14) on top of the lid.

14. Clamp screw
15. Ellipsometer stage lid
16. 22mm Window
17. 18mm Window

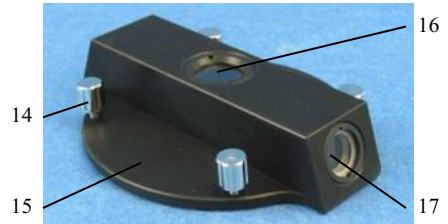

Using The Ellipsometer Stage With Vacuum Port

For ease of transportation the stage is supplied with the Gas Port (1) attached.

When using the Stage at temperatures below ambient to -196°C , **YOU MUST USE** the vacuum ports so that all moisture is removed by connecting to a vacuum pump.

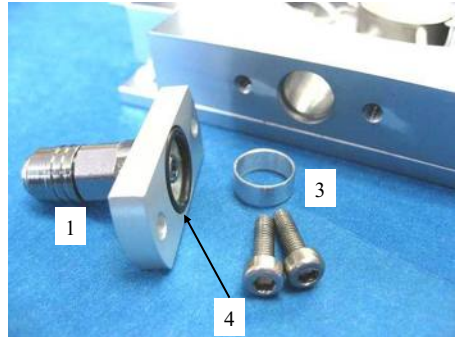

Use the hex key to remove the two screws on either side of the Gas Port (1). Using these screws to fit in the Extended Vacuum Port Connector (2). Make sure that the metal vacuum/gas seal insert (3) is placed between the stage and connector and the rubber O-ring (4) is in place as shown.

Note: the surfaces where the O-ring sits should be completely free of dirt. The O-ring should be smeared with a small amount of vacuum grease before loading in between the vacuum port and the stage vacuum connector.

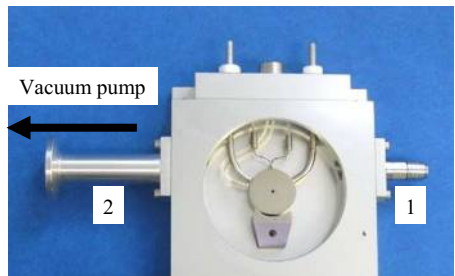
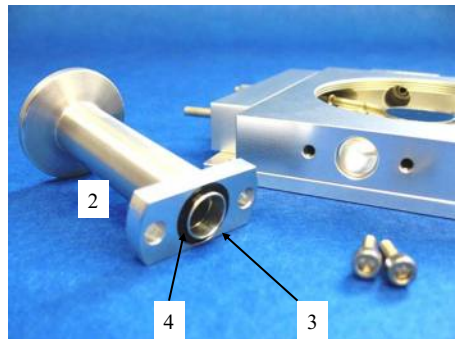

Use vacuum tubing with a KF16, 16mm flange with the supplied clamping ring NW16 (5) and centring rubber NW16 O-ring (6) to connect the stage to a vacuum pump. Ensure that the O-ring is seated correctly between the vacuum port and the vacuum tubing connector before tightening the clamping screw.

Note: the surfaces where the O-ring sits should be completely free of dirt. The O-ring should be smeared with a small amount of vacuum grease.

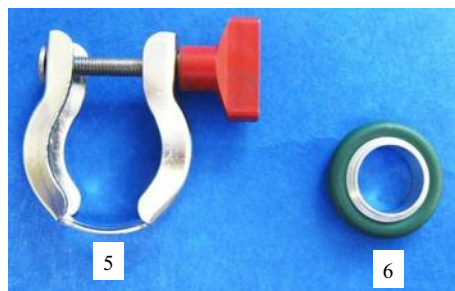

Ellipsometer Windows Assembly

If the windows need to be replaced they should be reassembled as shown in the diagram.

Top Window Assembly

Use the Window Tool (1) to remove the 22mm Locking Ring (2) and reassemble the Top Window as shown in the diagram.

1. Window Tool (1)
2. Locking Ring (22mm)
3. Silicon Rubber Ring (22 x 18mm)
4. Glass Window (22 x 0.3mm)

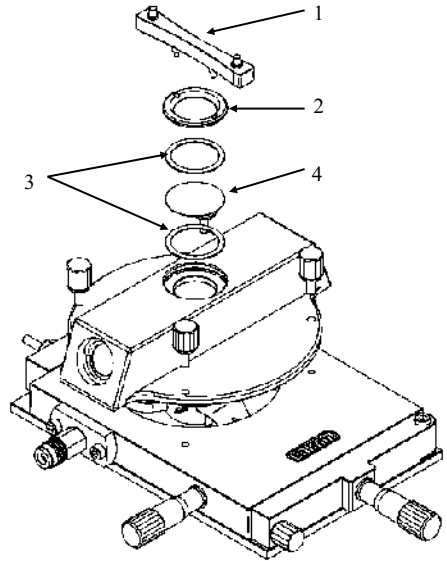

Side Windows Assembly

Use the Side Window Locking Tool (5) to remove the Side Window Locking Ring (6) and reassemble the Side Window as shown in the diagram

5. Side Window Locking Tool
6. Side Window Locking Ring
7. Silicon Rubber Ring (17 x 12mm)
8. Side Window (up to 5mm thick)

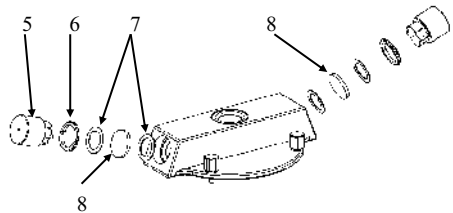

Bottom Window Assembly

Use the Window Tool (1) to remove the 22mm Locking Ring (2) and reassemble the Bottom Window as shown in the diagram.

1. Window Tool (1)
2. Locking Ring (22mm)
3. Silicon Rubber Ring (22 x 18mm)
4. Glass Window (22 x 0.3mm)

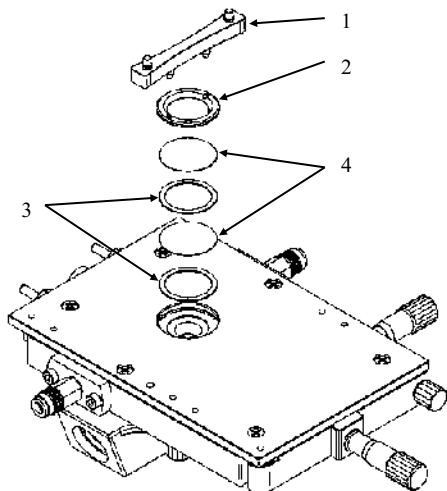

This page is intentionally blank

This page is intentionally blank

This page is intentionally blank

