

# Operating instructions

## CROSS BEATER MILL

### PULVERISETTE 16

Valid from serial number: 16.60X0/X0001



Read the instructions prior to performing any task!

---

Translation of the original operating instructions



## Certifications and CE conformity

### Certification

Fritsch GmbH has been certified by the SGS-TÜV Saar GmbH.



An audit certified that Fritsch GmbH conforms to the requirements of the DIN EN ISO 9001:2015.

### CE Conformity

The enclosed Conformity Declaration lists the guidelines the FRITSCH instrument conforms to, to be able to bear the CE mark.



## Table of contents

<b>1</b>	<b>Basic structure.....</b>	<b>6</b>
<b>2</b>	<b>Safety information and use.....</b>	<b>7</b>
	2.1 Requirements for the user.....	7
	2.2 Scope of application.....	7
	2.2.1 Operating principle.....	8
	2.3 Obligations of the operator.....	8
	2.4 Information on hazards and symbols used in this manual....	9
	2.5 Device safety information.....	11
	2.6 Protective equipment.....	13
<b>3</b>	<b>Technical data.....</b>	<b>14</b>
	3.1 Dimensions.....	14
	3.2 Weight.....	14
	3.3 Operating noise.....	14
	3.4 Drive motor.....	14
	3.5 Speed.....	14
	3.6 Power rating.....	14
	3.7 Particle feed size.....	14
	3.8 Collecting vessel volume.....	15
	3.9 Protection class.....	15
<b>4</b>	<b>Installation.....</b>	<b>16</b>
	4.1 Transport.....	16
	4.2 Unpacking.....	16
	4.3 Setting up.....	16
	4.4 Ambient conditions.....	17
	4.5 Setting up on a laboratory bench.....	17
	4.6 Fastening the Cross beater mill to the universal support stand.....	18
	4.7 Electrical connection.....	18
<b>5</b>	<b>Initial start-up.....</b>	<b>20</b>
	5.1 Switching on.....	20
	5.2 Function check.....	20
	5.3 Switching off.....	20
<b>6</b>	<b>Using the device.....</b>	<b>21</b>
	6.1 Operating elements and operation.....	22
	6.2 Opening and closing the mill housing.....	23
	6.2.1 Opening the device.....	23
	6.2.2 Closing the device.....	24
	6.3 Installing the grinding elements.....	24
	6.3.1 Einsetzen der Mahlraumkassette.....	24
	6.3.2 Inserting the bottom sieve.....	24

6.3.3	Inserting the cross beater.....	25
6.3.4	Inserting filter unit and collecting vessel.....	25
6.4	Conducting a grinding operation.....	26
<b>7</b>	<b>Accessories.....</b>	<b>27</b>
7.1	Collecting vessel.....	27
7.2	Universal support stand.....	27
<b>8</b>	<b>Cleaning.....</b>	<b>29</b>
8.1	Cleaning grinding elements.....	29
8.2	Cleaning the funnel.....	29
<b>9</b>	<b>Maintenance.....</b>	<b>30</b>
9.1	Replacement of the device fuse.....	31
9.2	Filzring Mahlraumkassette.....	31
9.3	Setting the impact plates.....	32
<b>10</b>	<b>Error display.....</b>	<b>33</b>
<b>11</b>	<b>Disposal.....</b>	<b>34</b>
<b>12</b>	<b>Guarantee terms.....</b>	<b>35</b>
<b>13</b>	<b>Exclusion of liability.....</b>	<b>37</b>
<b>14</b>	<b>Safety logbook.....</b>	<b>39</b>
<b>15</b>	<b>Index.....</b>	<b>40</b>

Basic structure

1 Basic structure



- 1 Funnel with hand guard
- 2 Grinding chamber cartridge
- 3 Sieve insert
- 4 Filter sack
- 5 Collecting vessel

- 6 Cross beater
- 7 Control panel
- 8 Door lock
- 9 Locking mechanism
- 10 Universal support stand (optional)

## **2 Safety information and use**

### **2.1 Requirements for the user**

This operating manual is intended for persons assigned with operating and monitoring the Fritsch PULVERISETTE 16. The operating manual and especially its safety instructions are to be observed by all persons working on or with this device. In addition, the applicable rules and regulations for accident prevention at the installation site are to be observed. Always keep the operating manual at the installation site of the PULVERISETTE 16.

People with health problems or under the influence of medication, drugs, alcohol or exhaustion must not operate this device.

The PULVERISETTE 16 may only be operated by authorised persons and serviced or repaired by trained specialists. All commissioning, maintenance and repair work may only be carried out by technically qualified personnel. Qualified personnel are persons who, because of their education, experience and training as well as their knowledge of relevant standards, regulations, accident prevention guidelines and operating conditions, are authorised by those responsible for the safety of the machine to carry out the required work and are able to recognize and avoid possible hazards as defined for skilled workers in IEC 364.

In order to prevent hazards to users, follow the instructions in this manual.

Malfunctions that impair the safety of persons, the PULVERISETTE 16 or other material property must be rectified immediately. The following information serves both the personal safety of operating personnel as well as the safety of the products described and any devices connected to them: All maintenance and repair work may only be performed by technically qualified personnel.

This operating manual is not a complete technical description. Only the details required for operation and maintaining usability are described.

Fritsch has prepared and reviewed this operating manual with the greatest care. However, no guarantee is made for its completeness or accuracy.

Subject to technical modifications.

### **2.2 Scope of application**

The function of the high-performance cross beater mill is the comminution of elastic and fibrous products and product mixtures in batches or on a continuous basis. In addition, this device is not designed to grind wet or moist materials. The special design of the cutting tools in conjunction with the drive produces a fast, efficient grinding without disruptive interference with the material to be comminuted.

The device allows particularly effective comminution of heterogeneous material mixtures such as e.g. slags, lime, stone samples or ores. The grinding stock is warmed only slightly, making the mill suitable for temperature-sensitive materials.



### NOTICE!

This laboratory instrument is designed for 8-hour shift operation at 30% duty cycle.

The device may not be used as a production machine or put into continuous operation.

### 2.2.1 Operating principle

Comminution in the cross beater mill is performed by beating, impact and shearing. After feeding the material for comminution into the funnel, it enters the grinding chamber where the comminution process takes place between the beating cross, the grinding insert and the bottom sieve.

As soon as the material for comminution has reached the appropriate final fineness, it passes through the bottom sieve into the collecting vessel.

If a textile filter hose is used between the cross beater mill and the collecting vessel, a backup of the material caused by the air current created by the rotating beating cross is avoided, and an increase in material throughput is to some extent achieved.

This ensures a gentle comminution process.

### 2.3 Obligations of the operator

Before using the PULVERISETTE 16, this manual is to be carefully read and understood. The use of the PULVERISETTE 16 requires technical knowledge; only commercial use is permitted.

The operating personnel must be familiar with the content of the operating manual. For this reason, it is very important that these persons actually receive the present operating manual. Ensure that the operating manual is always near the device.

The PULVERISETTE 16 may exclusively be used within the scope of applications set down in this manual and within the framework of guidelines put forth in this manual. In case of non-compliance or improper use, the customer assumes full liability for the functional capability of the PULVERISETTE 16 and for any damage or injury arising from failure to fulfil this obligation.

By using the PULVERISETTE 16 the customer agrees with this and recognizes that defects, malfunctions or errors cannot be completely excluded. To prevent risk of damage to persons or property or of other direct or indirect damage, resulting from this or other causes, the customer must implement sufficient and comprehensive safety measures for working with the PULVERISETTE 16.



Neither compliance with this manual nor the conditions and methods used during installation, operation, use and maintenance of the PULVERISETTE 16 can be monitored by Fritsch GmbH. Improper execution of the installation can result in property damage and thus endanger persons. Therefore, we assume absolutely no responsibility or liability for loss, damage or costs that result from errors at installation, improper operation or improper use or improper maintenance or are in any way connected to these.

The applicable accident prevention guidelines must be complied with.

Generally applicable legal and other obligatory regulations regarding environmental protection must be observed.

## 2.4 Information on hazards and symbols used in this manual

### Safety information

Safety information in this manual is designated by symbols. Safety information is introduced by keywords that express the extent of the hazard.

**DANGER!**

This symbol and keyword combination points out a directly hazardous situation that can result in death or serious injury if not avoided.

**WARNING!**

This symbol and keyword combination points out a possibly hazardous situation that can result in death or serious injury if not avoided.

**CAUTION!**

This symbol and keyword combination points out a possibly hazardous situation that can result in slight or minor injury if not avoided.

**NOTICE!**

This symbol and keyword combination points out a possibly hazardous situation that can result in property damage if not avoided.

### Special safety information

To call attention to specific hazards, the following symbols are used in the safety information:

## Safety information and use



### **DANGER!**

This symbol and keyword combination points out a directly hazardous situation due to electrical current. Ignoring information with this designation will result in serious or fatal injury.



### **DANGER!**

This symbol and keyword combination designates contents and instructions for proper use of the machine in explosive areas or with explosive substances. Ignoring information with this designation will result in serious or fatal injury.



### **DANGER!**

This symbol and keyword combination designates contents and instructions for proper use of the machine with combustible substances. Ignoring information with this designation will result in serious or fatal injury.



### **WARNING!**

This symbol and keyword combination points out a directly hazardous situation due to movable parts. Ignoring information with this designation can result in hand injuries.



### **WARNING!**

This symbol and keyword combination points out a directly hazardous situation due to hot surfaces. Ignoring information with this designation can result in serious burn injuries due to skin contact with hot surfaces.

### **Safety information in the procedure instructions**

Safety information can refer to specific, individual procedure instructions. Such safety information is embedded in the procedure instructions so that the text can be read without interruption as the procedure is being carried out. The keywords described above are used.

**Safety information and use**

Example:

1. ➔ Loosen screw.

2. ➔



**CAUTION!**  
Risk of entrapment at the lid.

Close the lid carefully.

3. ➔ Tighten screw.

**Tips and recommendations**



*This symbol emphasises useful tips and recommendations as well as information for efficient operation without malfunction.*

**Further designations**

To emphasise procedure instructions, results, lists, references and other elements, the following designations are used in this manual:

Designation	Explanation
➔ 1., 2., 3. ...	Step-by-step procedure instructions
⇒	Results of steps in the procedure
↗	References to sections in this manual and relevant documentation
■	Lists without a specific order
[Button]	Operating elements (e.g. push button, switch), display elements (e.g. signal lamps)
‘Display’	Screen elements (e.g. buttons, function key assignment)

**2.5 Device safety information**

**Please observe!**

- Only use original accessories and original spare parts. Failure to observe this instruction can compromise the safety of the machine.
- Accident-proof conduct is to be strictly followed during all work.
- Comply with all currently applicable national and international accident prevention guidelines.

## Safety information and use



### CAUTION!

#### Wear hearing protection!

If a noise level of 85 dB(A) is reached or exceeded, ear protection should be worn to prevent hearing damage.



### WARNING!

The maximum accepted concentration (MAC) levels of the relevant safety guidelines must be observed; if necessary, ventilation must be provided or the machine must be operated under an extractor hood.



### DANGER!

#### Explosion hazard!

- When Grinding oxidizable substances, e.g. metals or coal, there is a risk of spontaneous combustion (dust explosion) if the share of fine particles exceeds a certain percentage. When Grinding these kinds of substances, special safety measures must be taken and the work must be supervised from a specialist.
- The PULVERISETTE 16 is not explosion protected and is not designed to grind explosive materials.

- Do not remove the information signs.



### NOTICE!

Immediately replace damaged or illegible information signs.

- Unauthorised alteration of the PULVERISETTE 16 will void Fritsch's declaration of conformity to European directives and void the guarantee.
- Only use the PULVERISETTE 16 when it is in proper working order, as intended and in a safety- and hazard-conscious manner adhering to the operating manual. In particular, immediately rectify any malfunctions that could pose a safety hazard.
- If, after reading the operating manual, there are still questions or problems, please do not hesitate to contact our specialised personnel.

## 2.6 Protective equipment



*Protective equipment is to be used as intended and may not be disabled or removed.*

*All protective equipment is to be regularly checked for integrity and proper functioning.*

- If the mill is opened during operation, the motor stops within a very short time!
- The mill cannot be restarted while the grinding chamber is open.

## Technical data

### 3 Technical data

#### 3.1 Dimensions

400 x 500 x 510 mm (height x width x depth)

With underframe: 1250 x 700 x 900 mm (height x width x depth)

#### 3.2 Weight

Net: approx. 45 kg

Underframe optional: 18.7 kg

#### 3.3 Operating noise

Noise measurement according to DIN 45635-31-01-KL3.

Immission at 1m distance:

- approx. 68 dB (A) when idle

During comminution, depending on the grinding stock:

- approx. 85 to 95 dB (A) with peaks of up to 110 dB (A)

#### 3.4 Drive motor

Three-phase motor with brake

#### 3.5 Speed

The rated speed of the engine is 2000 - 4000 rpm.

#### 3.6 Power rating

1150 watts

#### 3.7 Particle feed size

Max. 25 mm

### 3.8 Collecting vessel volume

5000 ml or 30000 ml

### 3.9 Protection class

IP41

### 4 Installation

#### 4.1 Transport

The device is delivered on a transport pallet with a wooden cover. We recommend using a forklift or pallet truck for transporting the packed device.



**DANGER!**

Do not step under the transport pallet during transport.



**WARNING!**

Improper lifting can lead to personal injury or property damage. The machine is only to be lifted with suitable equipment and by qualified personnel.

The guarantee excludes all claims for damage due to improper transport.

#### 4.2 Unpacking

- Remove the screws attaching the front of the case.
- Lift it away.
- Compare the contents of the delivery with your order.

#### 4.3 Setting up



**DANGER!**

Do not step under the transport pallet during transport.



**CAUTION!**

**Crushing hazard!**

The weight of the cross beater mill is approx. 45 kg!



**NOTICE!**

Place the Cross beater mill on a flat, stable surface. It may be screwed to this or a base plate.

**NOTICE!**

Never operate PULVERISETTE 16 while it is standing on the transport pallet!

The cross beater mill is mounted on an underframe. Remove the screws and set the mill down on the required installation site with the help of the ring bolt.

#### 4.4 Ambient conditions

**WARNING!****Mains voltage!**

- The device may only be operated indoors.
- The surrounding air may not carry any electrically conductive dust.
- Maximum relative humidity 80% for temperatures up to 31°C, linearly decreasing down to 50% relative humidity at 40°C.

- The room temperature has to stay between 5 - 40°C.
- Altitudes up to 2000 m
- Degree of pollution 2 according to IEC 664.

#### 4.5 Setting up on a laboratory bench

You can mount the cross beater mill on a laboratory bench:

- Measure the thickness of the laboratory bench.
- Use screws with a maximum  $\varnothing$  8 mm and a length equal to the laboratory bench thickness + 25 mm.
- Place the cross beater mill together with the collecting vessel onto the bench.
- Mark bore holes on the bench for drilling using the existing bore holes of the U-beams beneath the cross beater mill.

The distance of the bore holes to the edge of the bench should be chosen such that the collecting vessel and the filter hose can be readily mounted and dismantled.

## 4.6 Fastening the Cross beater mill to the universal support stand



Setting up the universal support stand is described in chapter ↗ Chapter 7.2 'Universal support stand' on page 27.

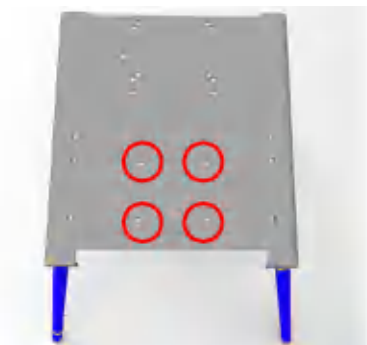

1. ➤ Position the PULVERISETTE 16 on the universal support stand. Ensure that the larger section of the stand is facing forward.



### CAUTION!

#### Hazard of tipping!

Secure the device against tipping until it is completely screwed down, as the centre of gravity allows the mill to tip forwards.

2. ➤ Attach the device to the stand with the attachment kit provided.
3. ➤ Place both bars with threaded bore holes into the U-beams sitting on the mounting plate. Take one spring ring and one washer for each of the screws and screw the device to the universal support stand from below.

## 4.7 Electrical connection



### DANGER!

#### Provide short-circuit protection!

Risk of damage due to short-circuits.

- Make sure that the socket is connected to a mains line protected with a residual current circuit breaker.



### CAUTION!

Ignoring the values on the type plate may result in damage to the electrical and mechanical components.

Before establishing the connection, compare the voltage and current values stated on the type plate with the values of the mains system to be used. (See ↗ Chapter 3 'Technical data' on page 14)

- Connect the Cross beater mill to the electrical outlet using the supplied connecting cable.
- External fuse protection is to be provided for the connection of the mains cable to the mains according to the regulations at the installation site.



**DANGER!**

**Mains voltage!**

Changes to the connection line may only be made by a qualified person.

## Initial start-up

### 5 Initial start-up



#### CAUTION!

Never operate the device without the bottom sieve in place!

Risk of injury through possibly reaching in from below!



#### CAUTION!

Only operate the device with the collecting vessel mounted!

Switch on the device only after all work as described in section [Chapter 4 'Installation' on page 16](#) has been carried out!

#### 5.1 Switching on



- Ensure that the mill is closed before switching on the device using the main switch on the reverse. (I)

#### 5.2 Function check



1. ➤ Set the speed to 2000 rpm on the control panel using the "+" and "-" buttons.
2. ➤ Start the function check by pressing the "START" button.
  - ⇒ The mill starts up.
3. ➤ Press the "STOP" button to stop the device.
  - ⇒ The cross beater is braked. After the engine comes to a stop, the door can be opened.

#### 5.3 Switching off

Switch the devices off (O) at the back using the main switch.

## 6 Using the device

**CAUTION!****Cut injuries**

Sharp cutting edges on the rotors and cutting bars

- The sharp cutting edges on the rotors and cutting bars can cause cuts to the hands.

**Use gloves when changing the cutting rotors and when cleaning the grinding chamber.**

**Use the rotor removing handle when working with the cutting rotors.**

**NOTICE!****Wear or damage to the device**

Operating without a grinding set

- Operating the device without a grinding set can lead to increased wear or damage to the device.

**Only operate the device when the grinding set has been inserted.**

**NOTICE!****Damage to mechanical components**

Blockage of the cutting mill

- When working on large-grained, harder particles, blockages can occur due to the increased drawing-in power of the standard rotor.

**Switch the device off immediately in the event of a blockage and remove the trapped grinding stock.**

Using the device

6.1 Operating elements and operation



- 1 Funnel
- 2 Grinding chamber cartridge with sieve frame
- 3 Ring filter
- 4 Filter sack
- 5 Collecting vessel

- 6 Cross beater
- 7 Control panel
- 8 Door lock
- 9 Locking mechanism
- 10 Frame

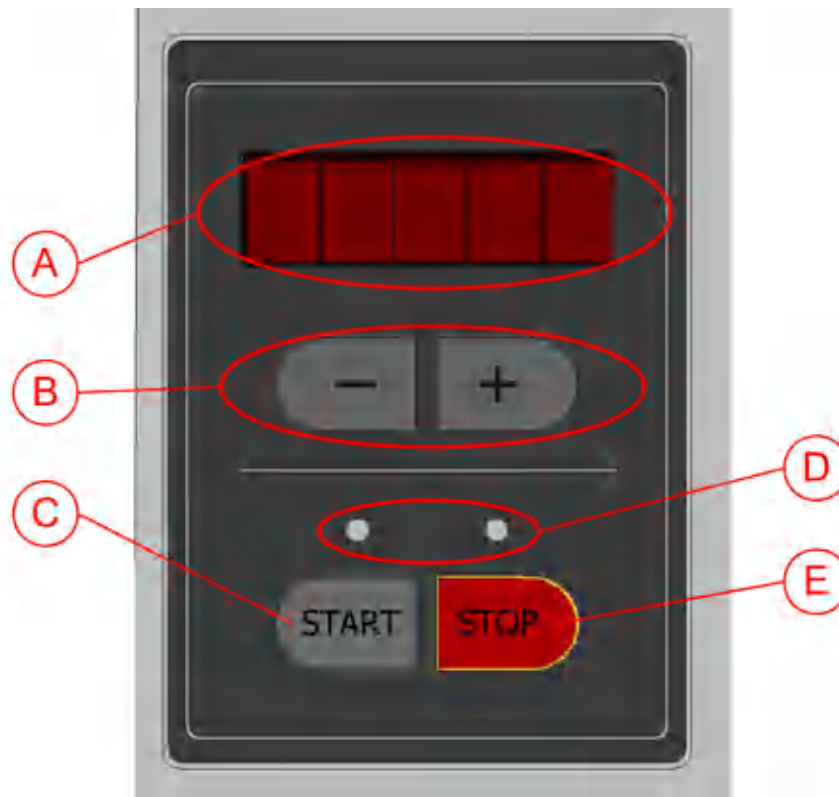

- A Display for control function and parameters
- B + and - buttons to adjust the speed
- C START button to start comminution
- D LED lights for status display
- E STOP button to stop comminution

## 6.2 Opening and closing the mill housing

### 6.2.1 Opening the device



1. ➤ Connect the device to the mains.
2. ➤ Switch on the main switch on the rear of the device.
3. ➤ H42 appears on the screen.
4. ➤ Pull the locking mechanism (8) out and hold it in position.
5. ➤ Pull the door lock (7) down.
  - ⇒ The door can now be opened.

## Using the device

### 6.2.2 Closing the device



*The grinding chamber can only be locked when the device is connected to the mains and the main switch on the rear of the device has been switched on.*

1. ➤ Close the door.
2. ➤ Pull the door lock (7) upwards.
3. ➤ The locking mechanism (8) clicks into place.

Only after the Start button has been pressed does the door lock electrically.

### 6.3 Installing the grinding elements



#### NOTICE!

The steps must be gone through in the sequence set out below. Before assembly it is essential to ensure that both the motor shaft and the mounting bore hole of the cross beater have been cleaned.

#### 6.3.1 Einsetzen der Mahlraumkassette

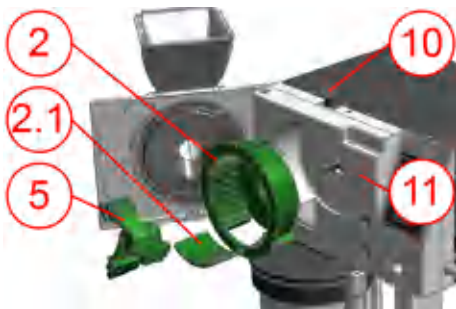

- Pull the knob (10) upwards.
- Align the grinding chamber cartridge (2) with the bolts in the housing.
- Insert the grinding chamber cartridge (2) into the housing and allow the bolt of the knob (10) to click into the perforation in the grinding chamber cartridge.

#### 6.3.2 Inserting the bottom sieve

- Slide the sieve frame (2.1) into the grinding chamber cartridge (2).



### 6.3.3 Inserting the cross beater

- Slide the cross beater (5) onto the motor shaft (11) and align it by pressing the feather key until the safety ring clicks into the groove on the motor shaft.

After this step you may close the device.



*To remove the grinding elements, follow the steps in reverse order.*

### 6.3.4 Inserting filter unit and collecting vessel



*When using a collective vessel without a filter unit, the release of dust from the funnel must be expected. Therefore never operate the PULVERISETTE 16 without a filter hose.*

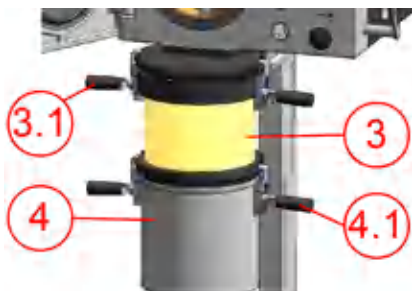

- 3 Filter hose
- 3.1 Filter hose lock
- 4 Collecting vessel
- 4.1 Collecting vessel lock



*Using a filter hose ensures that the air stream created by the impact rotor discharges downwards to the material output. In addition, the material throughput is increased and the separation of the solid matter in the air stream is ensured.*

1. ➔ Slide the filter hose (3) over the flange while holding the locks (3.1) at an angle.
2. ➔ Tighten these locks (3.1).
3. ➔ Mount the collecting vessel (4) while holding the locks (4.1) at an angle.
4. ➔ Tighten these locks (4.1).

### 6.4 Conducting a grinding operation

When all grinding elements have been properly inserted, proceed as follows to carry out a grinding:

1. ➤ The device must be switched on at the main switch on the rear.
2. ➤ Set the desired speed in the range of 2000 - 4000 rpm in steps of 200.
3. ➤ Start the mill by pressing the START button. The engine starts up and the cross beater turns at the preset speed.
4. ➤ If the mill has achieved its speed after a few seconds, add the material to be comminuted in small amounts into the funnel.

**The particle feed size should not be greater than 25 mm.**



*To identify the optimum sample quantity, start grinding with a small amount and observe the grinding noise. As soon as the quantity entered has been comminuted and the grinding noise dies down, add a slightly larger sample quantity into the funnel. Increase the sample added slowly. Above a certain filling quantity of the sample in the grinding chamber, the grinding noise changes noticeably under load. Reduce the amount added until the grinding noise has normalised again and maintain this quantity of added material.*

5. ➤ After grinding has finished, press the STOP button and remove the sample from the collecting vessel.



*For batch or continuous operation, the PULVERISETTE 16 can be retrofitted with the 30 l plastic container and the LABORETTE 24, available as accessories.*

## 7 Accessories

### 7.1 Collecting vessel



For batch or continuous operation, the PULVERISETTE 16 can be retrofitted with the 30 l plastic container and the LABORETTE 24, available as accessories.

### 7.2 Universal support stand

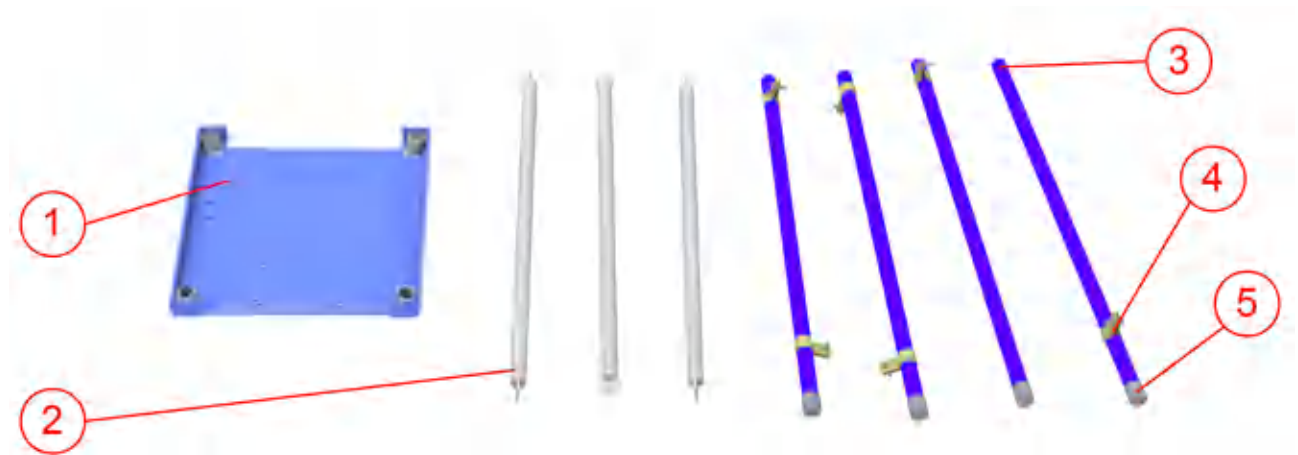

- 1 Mounting plate
- 2 3 x cross braces
- 3 4 x stand legs
- 4 6 x clamping rings + 12 x washers + 6 x M6 nuts + 6 x M6x25 cylinder screws
- 5 4 x protective caps

To assemble the universal support stand, proceed as follows:

1. ➤ Lay the mount plate on a flat surface.
2. ➤ Slide 2 clamping rings over 2 of the 4 stand legs.
3. ➤ Slide the remaining 2 clamping rings on the two other stand legs.
4. ➤ Screw the 4 stand legs into the mounting plate so that the ones with the 2 clamping rings on the side of the smaller section of the mounting plate are fastened.

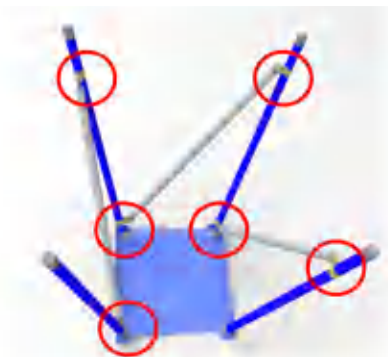

## Accessories

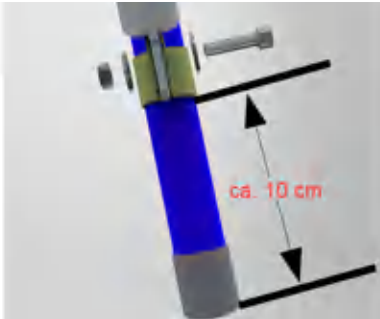

5. → The 3 lower clamping rings should be fastened at a distance of 10cm to the floor.
6. → Fit the 3 cross braces as shown in the image and screw to the clamping rings.



*A cross brace must be mounted on the back of the tripod. What is the rear side depends on the device to be mounted.*

## 8 Cleaning



### DANGER!

#### Mains voltage!

- Before beginning with cleaning work, disconnect the mains plug and protect the device against being unintentionally switched back on!
- Do not allow any liquids to flow into the device.
- Indicate cleaning work with warning signs.
- Put safety equipment back into operation after cleaning work.

### 8.1 Cleaning grinding elements

To facilitate cleaning, the grinding chamber, bottom sieve and cross beater can all be removed. For this, see Chapter  Chapter 6.3 'Installing the grinding elements' on page 24.



Before reinserting the grinding components, it is essential to ensure that both the motor shaft and the mounting bore hole of the cross beater have been cleaned.

### 8.2 Cleaning the funnel

To better clean the funnel, the splash guard can be removed.

To do so, proceed as follows:

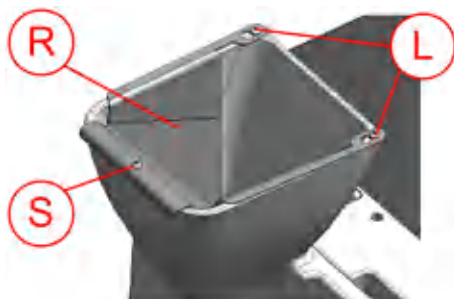

- Remove the screw (S)
- Loosen the two screws (L)
- Slide the splash guard (R) gently backwards.
- Lift the splash guard (R) up and out of the funnel

## 9 Maintenance



### **DANGER!**

#### **Mains voltage**

- Before beginning with maintenance work, unplug the mains plug and protect the device against being unintentionally switched back on again!
- Indicate maintenance work with warning signs.
- Maintenance work may only be performed by specialised personnel.
- Put safety equipment back into operation after maintenance or repair work



*We recommend keeping a safety logbook ↪ Chapter 14 'Safety logbook' on page 39, where all work (maintenance, repairs.....) performed on the device is entered.*



*The most important element of maintenance is regular cleaning:*

## 9.1 Replacement of the device fuse



### DANGER!

#### Danger to life due to power surges!

Exposed power contacts

- You could touch the fuses or fuse holder with live contacts when changing the fuses. Electric shocks can cause burns and cardiac arrhythmia or respiratory and cardiac arrests.

**Remove the mains cable before changing the fuses.**

Always replace both fuses:

**Fuse type: 2 x T10 A 250 V**

1. ➔ Press the two tabs of the fuse holder together and pull the fuse holder out.
2. ➔ Remove the fuses from the fuse holder and insert the new fuses.
3. ➔ Insert the fuse holder with the inserted fuses into the opening.



## 9.2 Filzring Mahlraumkassette



Grease the felt ring (F) in the grinding chamber cartridge every week with a few drops of machine oil.



If the felt ring is worn, remove the grinding set. Remove the metal ring (M) on the rear of the grinding chamber cartridge by loosening the 3 screws and replacing the felt ring (F). Put everything back together in the reverse order. (see Chapter ↗ Chapter 6.3 'Installing the grinding elements' on page 24)

### 9.3 Setting the impact plates

The impact plates experience a certain amount of wear during use. If there is a high degree of wear, the gap between the impact plates and grinding insert becomes too large. You can reset this gap with the help of the supplied setting plate.



1. ➤ Position the setting plate between one of the impact plates and the toothed inner side of the grinding insert and hold the plate in place.
2. ➤ Loosen the 2 hexagon screws which are used to fasten the impact plate.
3. ➤ Press the impact plate against the setting plate and retighten the two hexagon screws.
4. ➤ Perform these settings with the other two impact plates in the same manner.
5. ➤ Remove the setting plate. The impact plates have now been properly set.



## 10 Error display

Error code	(Error) description	Measures
E10	Drive overload	⇒ Switch off the main switch and wait for 30 s before switching on again. ⇒ If the error persists, contact service.
E11	Drive / engine error	⇒ Switch off the main switch and wait for 30 s before switching on again. ⇒ If the error persists, contact service.
E12	Motor brake error	⇒ Switch off the main switch and wait for 30 s before switching on again. ⇒ If the error persists, contact service.
E20	Control error	⇒ Switch off the main switch and wait for 30 s before switching on again. ⇒ If the error persists, contact service.
E22	Keypad error	⇒ Switch off the main switch and wait for 30 s before switching on again. ⇒ If the error persists, contact service.
E26	Frequency converter error	⇒ Switch off the main switch and wait for 30 s before switching on again. ⇒ If the error persists, contact service.
E41	Speed sensor error	⇒ Switch off the main switch and wait for 30 s before switching on again. ⇒ If the error persists, contact service.
E50	Safety circuit error	⇒ Switch off the main switch and wait for 30 s before switching on again. ⇒ If the error persists, contact service.
E51	Safety switch error	⇒ Switch off the main switch and wait for 30 s before switching on again. ⇒ If the error persists, contact service.
E80	Interface error	⇒ Switch off the main switch and wait for 30 s before switching on again. ⇒ If the error persists, contact service.
H10	Allow drive to cool down	⇒ Stop the grinding process. ⇒ Allow the device to cool down.
H41	Close grinding chamber	⇒ Close the door.

## 11 Disposal

It is hereby confirmed that FRITSCH has implemented the directive 2002/95/EC of the European Parliament and Council from 27th January 2003 for the limitation of the use of certain dangerous substances in electrical and electronic devices.

FRITSCH has registered the following categories according to the German electrical and electronic equipment act, section 6, paragraph 1, clause 1 and section 17, paragraphs 1 and 2:

**Mills and devices for the preparation of samples have been registered under category 6 for electrical and electronic tools (except for large stationary industrial tools).**

**Analytical devices have been registered under category 9, monitoring and control instruments.**

It has been accepted that FRITSCH is operating only in the business-to-business area. The German registration number for FRITSCH is WEEE reg. no. DE 60198769

### **FRITSCH WEEE coverage**

Since the registration of FRITSCH is classified for bilateral transactions, no legal recycling or disposal process is described. FRITSCH is not obliged to take back used FRITSCH devices.

FRITSCH declares it is prepared to take back used FRITSCH devices for recycling or disposal free of charge whenever a new device is purchased. The used FRITSCH device must be delivered free of charge to a FRITSCH establishment.

In all other cases FRITSCH takes back used FRITSCH devices for recycling or disposal only against payment.

## 12 Guarantee terms

### Guarantee period

As manufacturer, FRITSCH GmbH provides – above and beyond any guarantee claims against the seller – a guaranty valid for the duration of two years from the date of issue of the guarantee certificate supplied with the device.

Within this guarantee period, we shall remedy all deficiencies due to material or manufacturing defects free of charge. Rectification may take the form of either repair or replacement of the device, at our sole discretion. The guarantee may be redeemed in all countries in which this FRITSCH device is sold with our authorisation.

### Conditions for claims against the guarantee

This guarantee is subject to the condition that the device is operated according to the instructions for use / operating manual and its intended use.

Claims against the guarantee must include presentation of the original receipt, stating the date of purchase and name of the dealer, together with the complete device type and serial number.

**For this guarantee to take effect, the answer card entitled "Securing of Guarantee" (enclosed with the device) must be properly filled out and despatched without delay after receipt of the device and be received by us within three weeks or alternatively, online registration must be carried out with the above-mentioned information.**

### Reasons for loss of the guarantee

#### The guarantee will not be granted in cases where:

- Damage has arisen due to normal wear and tear, especially for wear parts, such as: Crushing jaws, support walls, grinding bowls, grinding balls, sieve plates, brush strips, grinding sets, grinding disks, rotors, sieve rings, pin inserts, conversion kits, sieve inserts, bottom sieves, grinding inserts, cutting tools, sieve cassettes, sieve and measuring cell glasses.
- Repairs, adaptations or modifications were made to the device by unauthorized persons or companies.
- The device was not used in a laboratory environment and/or has been used in continuous operation.
- Damage is present due to external factors (lightning, water, fire or similar) or improper handling.
- Damage is present that only insubstantially affects the value or proper functioning of the device.
- The device type or serial number on the device has been changed, deleted, removed or in any other way rendered illegible
- The above-mentioned documents have been changed in any way or rendered illegible.

## Guarantee terms

### Costs not covered by the guarantee

This guarantee excludes any costs for transport, packaging or travel that accrue in the event the product must be sent to us or in the event that one of our specialist technicians is required to come to your site. Any servicing done by persons not authorised by us and any use of parts that are not original FRITSCH accessories and spare parts will void the guarantee.

### Further information about the guarantee

The guarantee period will neither extend nor will a new period of guarantee begin in the event that a claim is placed against the guarantee.

Please provide a detailed description of the type of error or the complaint. If no error description is enclosed, we shall interpret the shipment as an assignment to remedy all recognisable errors or faults, including those not covered by the guarantee. Errors or faults not covered by the guarantee shall in this case be rectified at cost.

We recommend reading the operating manual before contacting us or your dealer, in order to avoid unnecessary inconvenience.

Ownership of defective parts is transferred to us with the delivery of the replacement part; the defective part shall be returned to us at buyer's expense.



#### **NOTICE!**

Please note that in the event that the device must be returned, the device must be shipped in the original Fritsch packaging. Fritsch GmbH denies all liability for any damage due to improper packaging (packaging not from Fritsch).

Any enquiries must include a reference to the serial number imprinted on the type plate.

## 13 Exclusion of liability

Before using the product, be sure to have read and understood this operating manual.

The use of the product requires technical knowledge; only commercial use is permitted.

The product may be used exclusively within the scope of applications set down in this operating manual and within the framework of guidelines put forth in this operating manual and must be subject to regular maintenance. In case of non-compliance, improper use or improper maintenance, the customer assumes full liability for the functional capability of the product and for damage or injury arising from violating these obligations.

The contents of this operating manual are subject in entirety to copyright law. This operating manual and its contents may not be copied, further distributed or stored in any form, in part or in whole, without the prior written consent of Fritsch.

This operating manual has been prepared to the best of our knowledge and checked for accuracy at the time of printing. FRITSCH GMBH assumes no guarantee or liability whatsoever for the accuracy or completeness of the contents of this operating manual, including but not limited to the implied warranties of merchantability and fitness for a particular purpose, unless liability is expressly prescribed by applicable laws or jurisprudence.

FRITSCH GMBH expressly reserves the right to modify and/or update this operating manual without prior notice. The same applies to modifications and improvements to the products described in this operating manual. It is the responsibility of the user to ensure that they have the current version of this operating manual. For more information, please contact your local FRITSCH GMBH distributor or Fritsch GmbH, Industriestr. 8, D-55473 Idar-Oberstein.

Not all parts shown here are necessarily installed in the product. The buyer is not entitled to delivery of these parts. If interested, please contact your local FRITSCH GMBH distributor or Fritsch GmbH, Industriestr. 8, D-55473 Idar-Oberstein.

FRITSCH GMBH takes the greatest care to ensure that the quality, reliability and safety of your products are continuously improved and adapted to the state of the art. The supplied products as well as this operating manual conform to the current state of the art when they leave the sphere of influence of FRITSCH GMBH.

By using the product the customer agrees with this and recognizes that defects, malfunctions or errors cannot be completely excluded. To prevent risk of damage to persons or property or of other direct or indirect damage, resulting from this or other causes, the customer must implement sufficient and comprehensive safety measures for working with the product.

## Exclusion of liability

Fritsch GmbH excludes any liability, warranty, or other obligation to compensate for damages, regardless of whether this liability, warranty, or other obligation is explicit or implicit, contractual or arising from unlawful acts or prescribed contractually, by law, or otherwise. In no event shall the buyer be entitled to any compensation from Fritsch GmbH for any special, direct, indirect, coincidental or consequential damage, including but not limited to lost profits, lost savings, lost sales or financial loss of any kind or for compensation of third parties, for downtimes, for lost goodwill, for damage to or replacement of equipment and property, for costs or restoration of materials or goods related to the product or the use of our products, for other damage or injury to persons (including fatal injuries) or similar. The above exclusion of liability is limited by mandatory liability as prescribed by laws or jurisprudence. Liability for negligence is excluded in all cases.

No permission is given expressly, implicitly or otherwise for the use of patents, brands or other copyrights. We also assume no liability for copyright infringements or infringements of the rights of third parties arising from the use of this product.

Neither compliance with this operating manual nor the conditions and methods used during installation, operation, use and maintenance of the product can be monitored by Fritsch GmbH. Improper execution of the installation can result in property damage and thus endanger persons. Therefore, we assume absolutely no responsibility or liability for loss, damage or costs that result from errors at installation, improper operation or improper use or improper maintenance or are in any way connected to these.

# 14 Safety logbook

Date	Maintenance / Repair	Name	Signature

## 15 Index

<b>A</b>	
Accident prevention . . . . .	7
Ambient conditions . . . . .	17
Authorised persons . . . . .	7
<b>C</b>	
Cleaning . . . . .	29
Closing the device . . . . .	24
Collecting vessel volume . . . . .	15
Control panel . . . . .	22
<b>D</b>	
Dimensions . . . . .	14
Disposal . . . . .	34
Drive motor . . . . .	14
<b>E</b>	
Electrical connection . . . . .	18
Exclusion of liability . . . . .	37
Explanation of signs . . . . .	9
Explanation of symbols . . . . .	9
<b>F</b>	
Function check . . . . .	20
<b>G</b>	
Guarantee terms . . . . .	35
<b>I</b>	
Initial start-up . . . . .	20
Inserting	
the bottom sieve . . . . .	24
the cross beater . . . . .	25
the grinding chamber cartridge . . . . .	24
the grinding elements . . . . .	24
<b>M</b>	
Maintenance . . . . .	30
<b>O</b>	
Opening the device . . . . .	23
Operating noise level . . . . .	14
<b>P</b>	
Particle feed size . . . . .	14
Power rating . . . . .	14
Protective equipment . . . . .	13
<b>R</b>	
Requirements for the user . . . . .	7
Rotational speed . . . . .	14
<b>S</b>	
Safety information . . . . .	9
Safety logbook . . . . .	39
Setting up . . . . .	16
Skilled workers . . . . .	7
Switching off . . . . .	20
Switching on . . . . .	20
<b>U</b>	
Using the device . . . . .	21
<b>W</b>	
Warning information . . . . .	9
WEEE . . . . .	34
Weight . . . . .	14





