

Quick Response Guide

AU480 Chemistry Analyzer

For *In Vitro* Diagnostic Use

CE B28625AA
December 2013



Beckman Coulter, Inc.
250 S. Kraemer Blvd.
Brea, CA 92821 U.S.A



AU480 Chemistry Analyzer

Quick Response Guide

PN B28625AA (December 2013)

© 2013 Beckman Coulter, Inc.
All Rights Reserved

Trademarks

The following are trademarks of Beckman Coulter, Inc.
and are registered in the USPTO:

- Beckman
- Beckman Coulter
- The Beckman Coulter logo
- AU

All other trademarks are the property of their respective owners.

Find us on the World Wide Web at:

www.beckmancoulter.com



Beckman Coulter Ireland Inc.
Lismeehan

e Lab Ltda

Estr dos Romeiros, 220 - Galpao G3 - Km 38.5
06501-001 - Sao Paulo - SP - Brasil
CNPJ: 42.160.812/0001-44

製造販売業者：ベックマン・コールター株式会社
東京都江東区有明三丁目 5 番 7 号
TOC 有明ウエストタワー

Beckman Coulter KK
贝克曼库尔特株式会社
東京都江東区有明三丁目 5 番 7 号
邮编 :135-0063

Revision History

This document applies to the latest software listed and higher versions. When a subsequent software version changes the information in this document, a new issue will be released.

Initial Issue, B28625AA, 12/2013

Software version 1.72

This document was created to:

- Replace the current regional Quick Response Guide with a single global document
- Improve the content and usability of the instructions

Revision History, iii

CHAPTER 1: Introduction, 1-1

- 1.1 Typographical Conventions Used in this Guide, 1-2
 - 1.1.1 Tips, Cautions, and Warnings, 1-2
 - 1.1.2 Software Paths, Menus, and Tabs, 1-3
 - 1.1.3 Software Buttons, 1-5
 - 1.1.4 Images of Software Screens, 1-5
 - 1.1.5 Analyzer Modes, 1-6
 - 1.1.6 Notation of Units, 1-6
 - 1.1.7 Third-Party Trademarks and Trade Names, 1-6

CHAPTER 2: System Outline, 2-1

- 2.1 Hardware Overview, 2-2
- 2.2 Software Chart, 2-4
- 2.3 Navigating Through the Software, 2-6
 - 2.3.1 How to Select Menus and Items, 2-6
 - 2.3.2 How to Exit Menus, 2-6
 - 2.3.3 Entry Status Display, 2-6
 - 2.3.4 Menus, Tabs, Buttons, and Function Keys, 2-7
- 2.4 Software Description, 2-8
 - 2.4.1 Organization of Operation Window, 2-9
 - 2.4.2 Main Button Bar, 2-10
 - 2.4.3 Home Outline, 2-12
 - 2.4.4 Menu List Overview, 2-16
 - 2.4.5 User Menu Overview, 2-17
 - 2.4.6 Using the Online Help, 2-18

2.4.7 Analyzer Modes, 2-20
, 2-21

CHAPTER 3: Daily Startup, 3-1

- 3.1 Start the System, 3-2
 - 3.1.1 Turn On the System, 3-2
 - 3.1.2 Set the Start Conditions, 3-3
- 3.2 Perform Daily Maintenance, 3-7
- 3.3 Check Analyzer Status, 3-8
- 3.4 ISE (Option) Startup, 3-10
 - 3.4.1 Check the ISE Reagent, 3-10
 - 3.4.2 Perform ISE Daily Maintenance, 3-12
- 3.5 Check Reagent Status, 3-13
 - 3.5.1 Check Reagent Quantity and Status, 3-13
 - 3.5.2 Review Detailed Information, 3-17
 - 3.5.3 Reagent Replacement, 3-20
- 3.6 Perform Calibration, 3-26
 - 3.6.1 Requisition and Perform Calibration from Racks, 3-27
 - 3.6.2 Requisition and Perform Calibration from the STAT Table, 3-30
- 3.7 Perform Quality Control (QC), 3-35
 - 3.7.1 Requisition and Perform QC from Racks, 3-37
 - 3.7.2 Requisition and Perform QC from the STAT Table, 3-39
- 3.8 Start Analysis, 3-43
 - 3.8.1 Start Rack Analysis, 3-43
 - 3.8.2 Start STAT Table Analysis, 3-44

CHAPTER 4: Processing Samples, 4-1

- 4.1 Prepare Samples for Analysis, 4-2
 - 4.1.1 Rack Types, 4-2
 - 4.1.2 Place the Sample Cups/Tubes in a Rack, 4-3

- 4.2 Placing Racks on the Rack Supply Unit, 4-6
- 4.3 Requisition for Routine and Emergency Samples, 4-9
 - 4.3.1 Enter Manual Requisitions for Routine and Emergency Samples, 4-10
 - 4.3.2 Enter Batch Requisitions, 4-13
 - 4.3.3 Download Requisitions from a Host Computer, 4-14
- 4.4 Processing Emergency Samples, 4-17
- 4.5 Priority STAT Samples, 4-18
 - 4.5.1 Enter Manual Requisitions for Priority STAT Samples, 4-18
 - 4.5.2 Processing Priority STAT Samples, 4-19

CHAPTER 5: Monitoring Results, 5-1

- 5.1 Monitor Results, 5-2
- 5.2 Identifying Sample Types by Sample Data Prefix, 5-3
- 5.3 Sample Status Menu, 5-4
- 5.4 Reports, 5-7
- 5.5 Check for Error Flags and Alarms, 5-8
 - 5.5.1 Check for Error Flags, 5-8
 - 5.5.2 Check for Alarms, 5-9

CHAPTER 6: As Needed Tasks, 6-1

- 6.1 Program a New Test, 6-3
- 6.2 Create a Profile, 6-11
 - 6.2.1 Create a Sample Profile, 6-12
 - 6.2.2 Create a Reagent Blank or Calibration Profile, 6-13
 - 6.2.3 Create a QC Profile, 6-14
- 6.3 Program Calibrator Concentrations, 6-16
- 6.4 Program Preset QC Mean and Range, 6-19

- 6.5 Program the Automatic Startup Function, 6-20
- 6.6 Program a User Menu, 6-23
 - 6.6.1 Edit the User Menu, 6-24
 - 6.6.2 Delete, 6-25
- 6.7 Print Results, 6-27
 - 6.7.1 Print Sample Data Reports, 6-27
 - 6.7.2 Print Reagent Blank, Calibration, and QC Results, 6-30
- 6.8 Transfer Data to Host Computer, 6-32
 - 6.8.1 Sample Data, 6-32
 - 6.8.2 Reagent Blank, Calibration, and QC Data, 6-33
- 6.9 Fix (Assign) a Reagent Position, 6-34
- 6.10 Edit a Reagent ID, 6-36
- 6.11 Reagent Inventory, 6-37
 - 6.11.1 Auto Calculation of Reagent Inventory, 6-37
 - 6.11.2 Manual Calculation of Reagent Inventory, 6-39
- 6.12 Reagent Consumption, 6-40
 - 6.12.1 Check Reagent Consumption by Samples Measured and Reagent Dispense, 6-41
 - 6.12.2 Save Reagent Consumption Data, 6-41
- 6.13 Edit Quality Control Data, 6-43
- 6.14 Save Data to External Media, 6-47
- 6.15 Save or Load Parameters, 6-50
 - 6.15.1 Save or Load Parameter Files, 6-50
- 6.16 Disable a Test, 6-53

CHAPTER 7: Analyzer Modes, 7-1

- 7.1 Analyzer Modes, 7-2
- 7.2 Bypass Warm Up to Standby Mode, 7-4
- 7.3 System Shutdown (End Process), 7-5

7.4 Transfer the Analyzer to Stop Mode, 7-7

7.4.1 Stop Analysis, 7-7

7.4.2 Return to Standby Mode, 7-8

7.5 Perform an Emergency Stop, 7-9

7.5.1 Return to *Standby* Mode, 7-9

CHAPTER 8: Troubleshooting, 8-1

8.1 Using the Online Help, 8-2

8.2 Review Alarms and Corrective Actions, 8-4

8.3 Review Error Flags, 8-6

Index

This Quick Response Guide describes basic system operations. It contains general information on preparing for analysis, starting analysis, and obtaining results. It also describes other frequently used procedures performed during daily routine operations. For detailed procedures, refer to the *AU480 User's Guide*.

This chapter discusses the following topics:

1.1 Typographical Conventions Used in this Guide

1.1.1 Tips, Cautions, and Warnings

1.1.2 Software Paths, Menus, and Tabs

1.1.3 Software Buttons

1.1.4 Images of Software Screens

1.1.5 Analyzer Modes

1.1.6 Notation of Units

1.1.7 Third-Party Trademarks and Trade Names

1.1 Typographical Conventions Used in this Guide

This section describes the conventions used in the text of this guide:

[1.1.1 Tips, Cautions, and Warnings](#)

[1.1.2 Software Paths, Menus, and Tabs](#)

[1.1.3 Software Buttons](#)

[1.1.4 Images of Software Screens](#)

[1.1.5 Analyzer Modes](#)

[1.1.6 Notation of Units](#)

[1.1.7 Third-Party Trademarks and Trade Names](#)

1.1.1 Tips, Cautions, and Warnings

This guide uses the following symbolic icons and terms according to the content of information. Each convention and term indicates the level of its importance. A thorough understanding of this information is necessary to use the system safely and correctly.



This symbol indicates a warning. Warnings mean that care must be exercised. Failure to follow these warnings may result in serious injury, degradation of system function, or generate incorrect sample data.



This symbol indicates a caution. Cautions mean that appropriate care must be taken. Failure to follow these cautions may result in minor injury, sub-optimal system performance, operation, or damage, which could lead to other hazards.

TIP Tips contain important information that users should take into consideration when performing procedures and understanding concepts.

For other precautions, refer to CHAPTER 2, *Precautions, Installation, and Specifications* in the *AU480 User's Guide*.

1.1.2 Software Paths, Menus, and Tabs

A software path is a sequence of options selected in the software interface in the order indicated. All menus and tabs appear in a **Bold** font.

Software paths in this guide are expressed as follows:

Select **Menu List > Maintenance > User Maintenance > ISE Maintenance**.

Following this path, first select **Menu List**, then **Maintenance**, then **User Maintenance**, and finally **ISE Maintenance** on the resulting submenu.

Figure 1.1

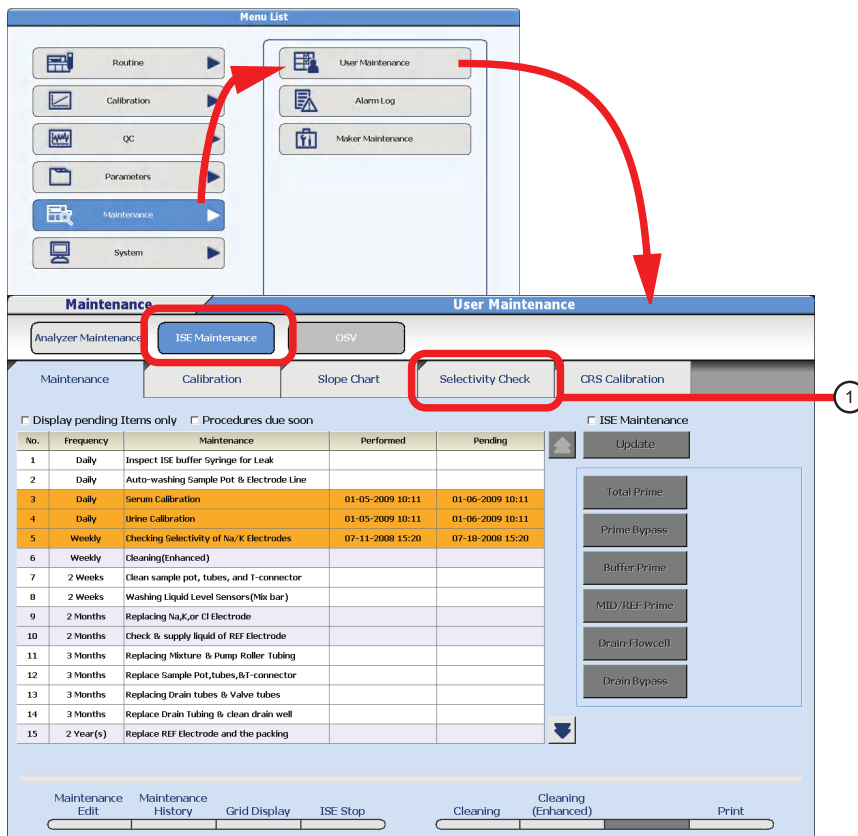

1. Selectivity Check tab

1.1.3 Software Buttons

All buttons that appear in the software interface are part of a single procedural step and appear in a **Bold** font. Some software buttons have a corresponding function key that can be accessed on the keyboard. These buttons appear in a **Bold** font with the corresponding keyboard function number in parenthesis. Refer to the following screen shot for an example.

Figure 1.2 Software buttons

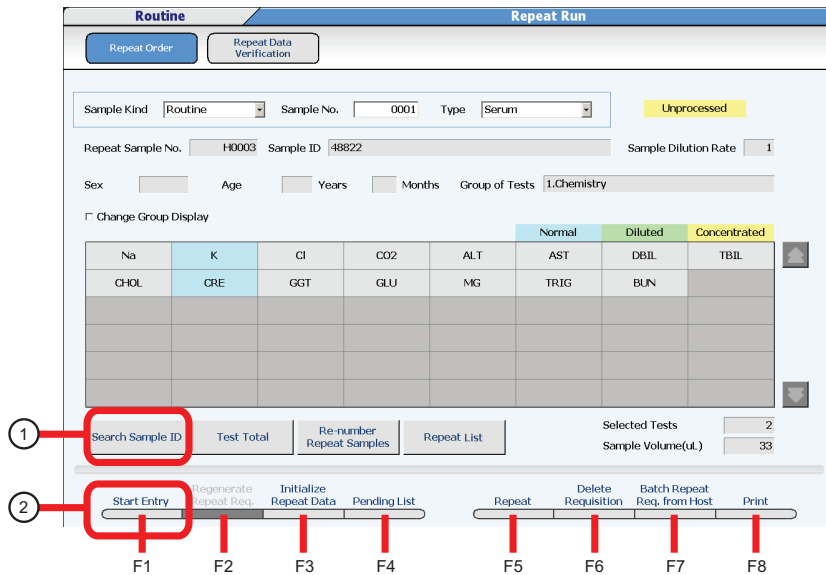

1. Search Sample ID button
2. Start Entry (F1) button

1.1.4 Images of Software Screens

Images of software screens in this guide may differ from the actual appearance of the software screen depending on how the system parameters are programmed.

Introduction

1.1 Typographical Conventions Used in this Guide

1.1.5 Analyzer Modes

Analyzer modes are written in italics. For example, *Standby* and *Measure* are normal analyzer modes.

1.1.6 Notation of Units

Units are denoted with the International System of Units (SI).

1.1.7 Third-Party Trademarks and Trade Names

All third-party trademarks and trade names referenced in this *Quick Response Guide* are the property of their respective owners.

This chapter discusses the following topics:

- 2.1 Hardware Overview
- 2.2 Software Chart
- 2.3 Navigating Through the Software
 - 2.3.1 How to Select Menus and Items
 - 2.3.2 How to Exit Menu
 - 2.3.3 Entry Status Display
 - 2.3.4 Menus, Tabs, Buttons, and Function Keys
- 2.4 Software Description
 - 2.4.1 Organization of Operation Window
 - 2.4.2 Main Button Bar
 - 2.4.3 Home Outline
 - 2.4.4 Menu List Overview
 - 2.4.5 User Menu Overview
 - 2.4.6 Using the Online Help
 - 2.4.7 Analyzer Modes

2.1 Hardware Overview

For a detailed description of the hardware components, refer to 3.4 Understanding the System Hardware in the *AU480 User's Guide*, chapter 3.

Figure 2.1 Top View

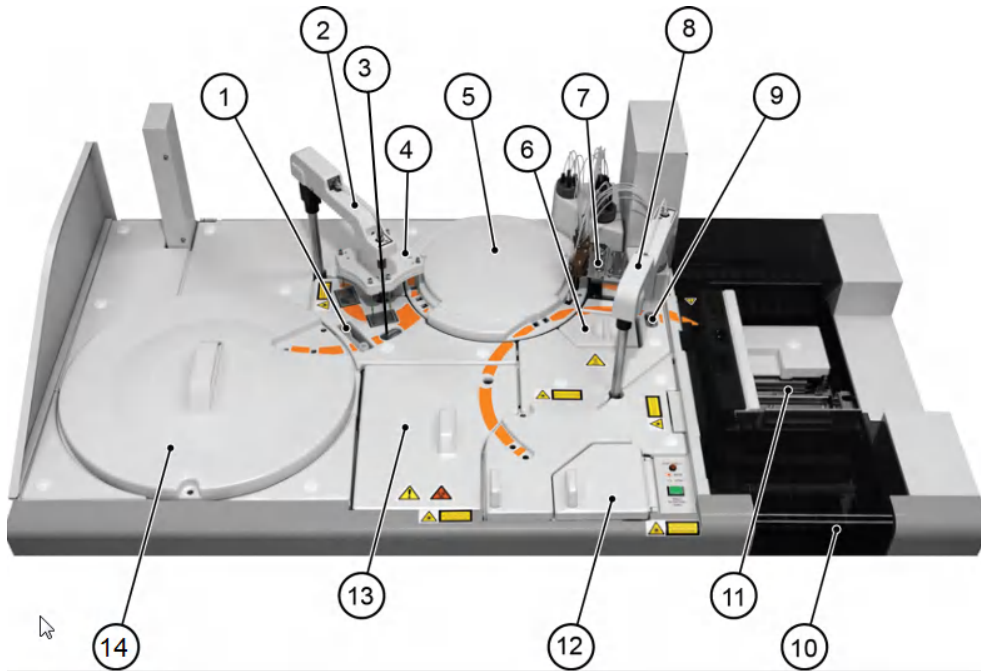

- | | |
|----------------------------|---------------------------|
| 1. Pre-dilution bottle | 8. Sample transfer unit |
| 2. Reagent transfer unit | 9. Sample probe wash well |
| 3. Reagent probe wash well | 10. Rack Feeder Unit |
| 4. Mixing unit | 11. Rack collection unit |
| 5. Cuvette wheel unit | 12. STAT table |
| 6. Photometer lamp | 13. ISE unit (optional) |
| 7. Wash nozzle unit | 14. Reagent refrigerator |

Figure 2.2 Front view

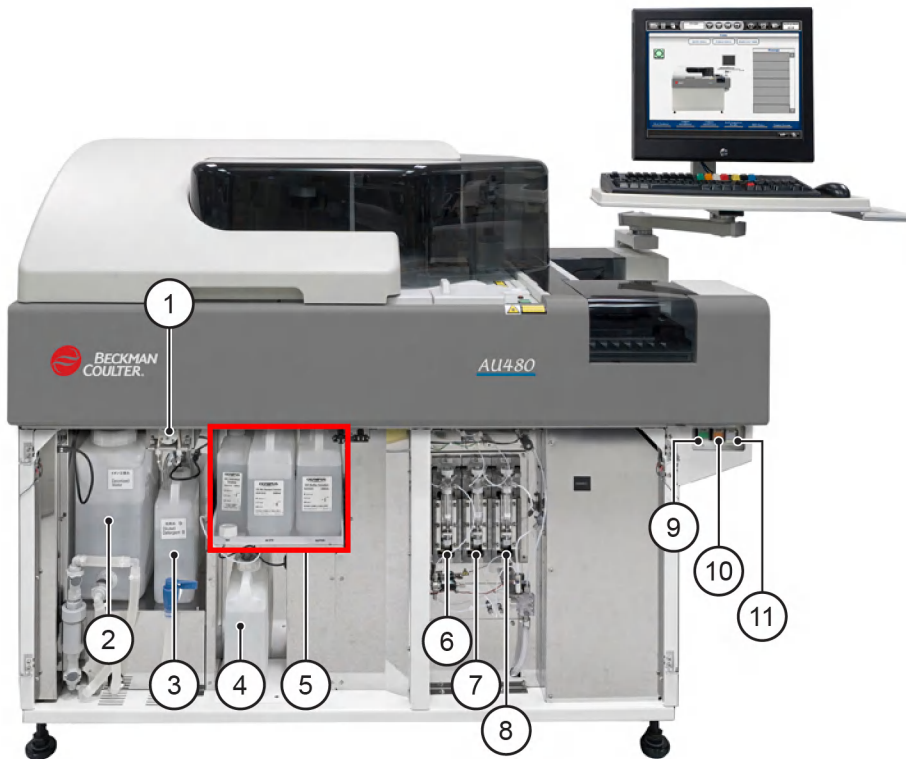

- | | |
|-------------------------------|--------------------------------------|
| 1. Wash Solution Roller Pump | 7. ISE Buffer (R) Syringe (Optional) |
| 2. DI Water Tank | 8. Sample (S) Syringe |
| 3. Diluted Wash Solution Tank | 9. ON button (green) |
| 4. Wash Solution Tank | 10. EM STOP button (red) |
| 5. ISE Reagents (Optional) | 11. RESET button (white) |
| 6. Reagent (R) Syringe | |

2.2 Software Chart

| Main Menu | Routine | Calibration | QC |
|------------------|---------------------------|-----------------------------------|-----------------------|
| | Start Condition | Calibration Monitor | QC Monitor ▶ |
| | Reagent ▶ | Calibration Verification ▶ | Daily Chart |
| | Reagent Management | Calibration Verification | Day to Day Chart |
| | Reagent Inventory | Material Parameters | Twin Plot Chart |
| | Reagent Consumption | | QC Data Review |
| | Rack Requisition ▶ | | |
| | Sample | | |
| | Calibration | | |
| | QC | | |
| | STAT Requisition ▶ | | |
| | STAT Status | | |
| | Sample | | |
| | Calibration | | |
| | QC | | |
| | Repeat Run ▶ | | |
| | Repeat Order | | |
| | Repeat Data Verification | | |
| | Sample Manager ▶ | | |
| | Sample | | |
| | RB/CAL/QC | | |
| | Data Monitor ▶ | | |
| | Reaction Monitor | | |
| | Data Statistics | | |
| | Correlation Chart | | |

| Parameters | Maintenance | System |
|---|---|---|
| <p>Common Test Parameters ▶</p> <ul style="list-style-type: none"> Test Name Profile Group of Tests <p>Specific Test Parameters ▶</p> <ul style="list-style-type: none"> General LIH ISE Calculated Tests Range <p>Repeat Parameters ▶</p> <ul style="list-style-type: none"> Repeat Common Repeat Specific <p>Calibration Parameters ▶</p> <ul style="list-style-type: none"> Calibrators Calibration Specific STAT Table Calibration <p>QC Parameters ▶</p> <ul style="list-style-type: none"> Controls QC Specific STAT Table QC <p>Misc.</p> <ul style="list-style-type: none"> Checked Tests Contamination Parameters Data Check Parameters | <p>User Maintenance ▶</p> <ul style="list-style-type: none"> Analyzer Maintenance ISE Maintenance <p>Alarm Log</p> <p>Maker Maintenance ▶</p> <ul style="list-style-type: none"> Program Version Analyzer Diag ISE Diag | <p>Online</p> <p>Format ▶</p> <ul style="list-style-type: none"> Requisition Format List Format <p>Comment Masters</p> <p>System Condition ▶</p> <ul style="list-style-type: none"> Analysis Mode Set Date and Time Auto Power On Password Login Condition <p>User Menu</p> <p>Data Management ▶</p> <ul style="list-style-type: none"> External Data Management File Management Offline Format |

2.3 Navigating Through the Software

The system is controlled using the standard windows graphical user interface (GUI).

[2.3.1 How to Select Menus and Items](#)

[2.3.2 How to Exit Menus](#)

[2.3.3 Entry Status Display](#)

[2.3.4 Menus, Tabs, Buttons, and Function Keys](#)

2.3.1 How to Select Menus and Items

- Touchscreen
- Mouse
- Keyboard

2.3.2 How to Exit Menus

- Select **Home**, **Menu List**, or **User Menu**.

2.3.3 Entry Status Display

- Select **Edit (F1)** or **Start Entry (F1)** to edit an item. The background color changes from light gray to white for items that can be edited.
- Select **Confirm (F1)** to confirm the change. The background color changes from white back to light gray.
- Select **Close** to exit certain windows.

2.3.4 Menus, Tabs, Buttons, and Function Keys

- Select menus, tabs, buttons, and function buttons/keys to open additional windows.

Figure 2.3

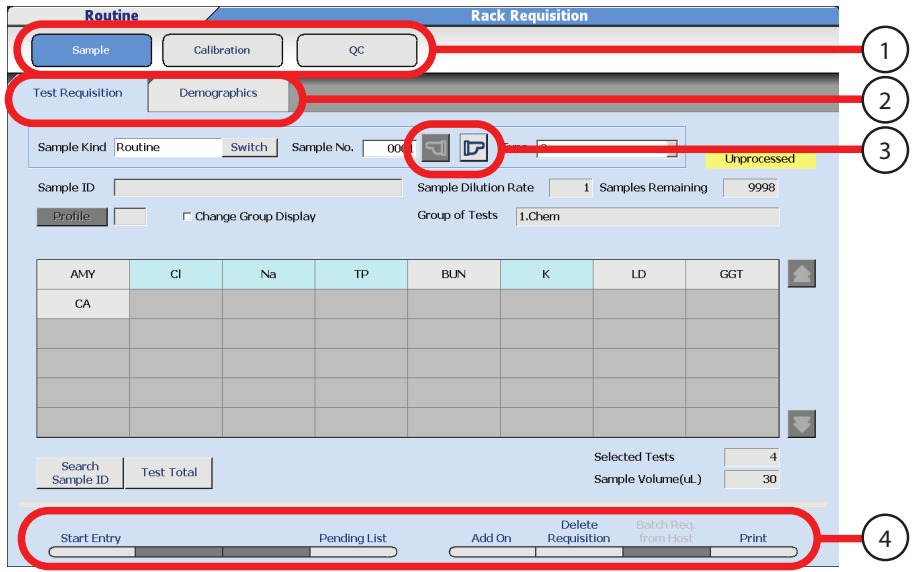

- 1. Menu
- 2. Tabs
- 3. Buttons
- 4. Function Buttons/Keys

2.4 Software Description

The system is controlled using the standard windows graphical user interface (GUI).

[2.4.1 Organization of Operation Window](#)

[2.4.2 Main Button Bar](#)

[2.4.3 Home Outline](#)

[2.4.4 Menu List Overview](#)

[2.4.5 User Menu Overview](#)

[2.4.6 Using the Online Help](#)

[2.4.7 Analyzer Modes](#)

2.4.1 Organization of Operation Window

This interface is composed of three main window display areas.

Figure 2.4

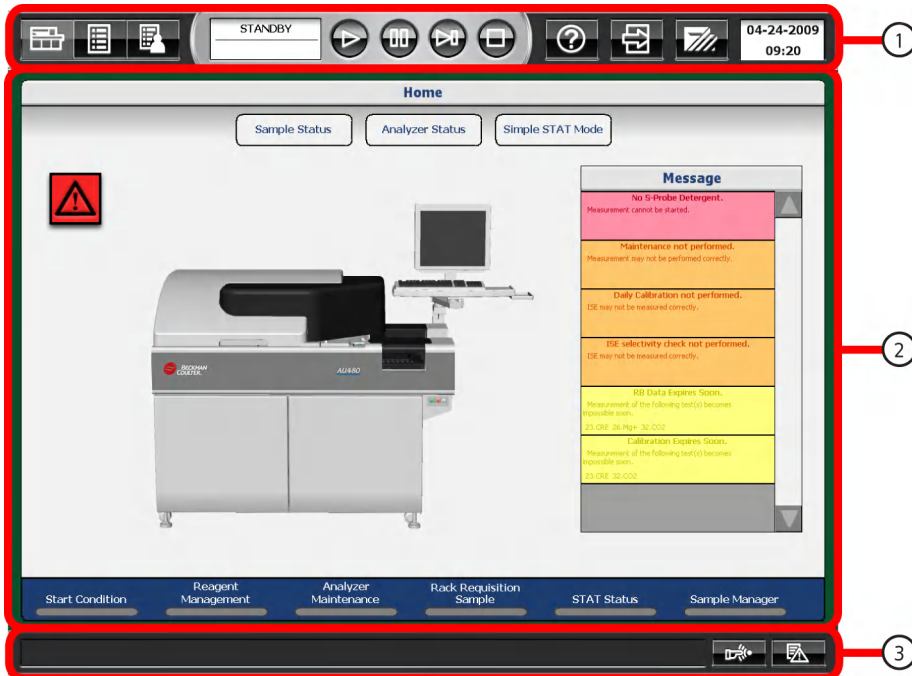

1. Main button bar

Buttons to display the main menus (**Home**, **Menu List**, **User Menu**) and access **Help**. **Start**, **Pause**, **Feeder Stop**, **Stop**, and **End Process** are the main operational buttons for the analyzer.

2. Menu area







A display and operation area for each menu or button selected.





3. Alarm area

The display area for the alarm messages generated during system operation, and the **Alarm Clear** and **Alarm List** buttons.

2.4.2 Main Button Bar

The system can be navigated by using the main buttons:

| Button | Actions |
|---|--|
|  <p>Home</p> | Returns to the Home menu. |
|  <p>Menu List</p> | Displays the Menu List menu. |
|  <p>User Menu</p> | Displays the User Menu set by the user. Refer to 4.10.7 Program a User Menu in the <i>AU480 User's Guide</i> . |
| <p>STANDBY</p> <hr/> <p>Mode Display Area</p> | Displays the current mode. The time to completion displays for some maintenance procedures. |
|  <p>Start</p> | Starts analysis. |
|  <p>Pause</p> | Pauses analysis. The system pauses at the first test for which no R1 reagent was dispensed. |
|  <p>Feeder Stop</p> | Stops the rack feeder. The analysis of samples in racks which have already been loaded continues. |

| Button | Actions |
|---|--|
|  Stop/Standby | <p>Stops analysis.</p> <p>In <i>Stop</i> mode, select this button to return the system to <i>Standby</i> mode.</p> |
|  Help | <p>Displays a menu to access user documentation and a maintenance video directory.</p> |
|  Logout | <p>Logs out and logs in a user.</p> |
|  End | <p>Performs an End Process.</p> <p>The End Process turns off the auxiliary power supply, including the lamp and computer.</p> |
|  Time Display Area | <p>Displays the present date and time.</p> |

2.4.3 Home Outline

The system can be navigated by using the main buttons.

This is the screen to check system messages relating to sample status and analyzer status. Jump buttons provide direct menu access to the most frequently used menus to simplify software navigation.

Figure 2.5

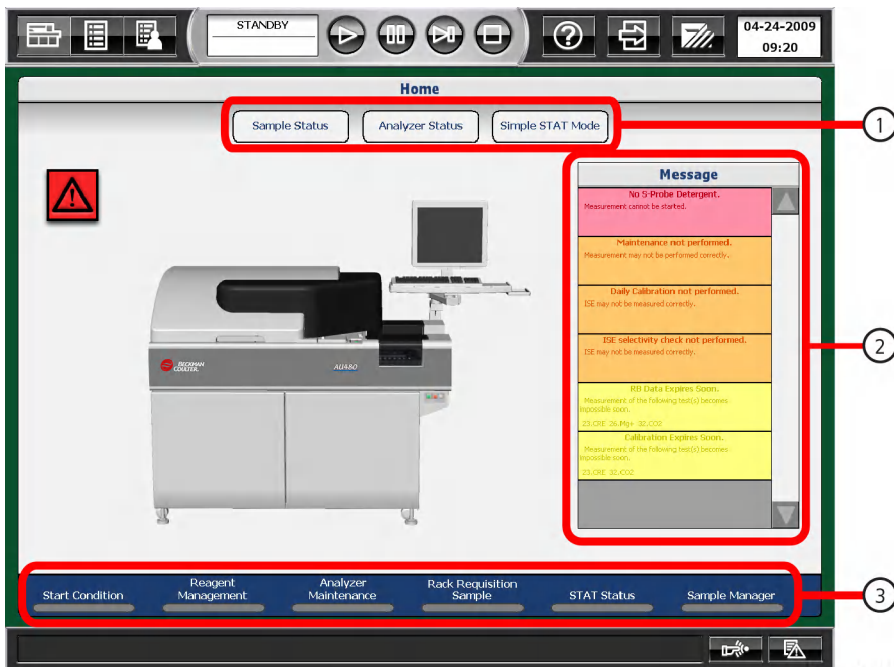

1. Menu buttons
2. Message display
3. Jump buttons

Menu buttons

| Menu Button | Action |
|-------------------------|---|
| Sample Status | Displays the sample status under analysis, time to completion, and results. |
| Analyzer Status | Displays the analyzer status and temperatures. |
| Simple STAT Mode | Processes STAT samples one at a time with minimal operator actions required. It is not possible to process samples in the normal analyzer operation modes. |

Message display

Displays messages regarding system conditions that could affect analysis results.

Color-coding indicates the level of the message:

Table 2.1 Message display

| Color | Meaning |
|---------------|--|
| Red | Analysis cannot be started until the message is addressed. |
| Orange | Analysis can be started. Review the message carefully and take appropriate action. |
| Yellow | Analysis can be started. Review the message carefully and take appropriate action. The message can shift to Orange Status (more critical). |
| Green | A notification of system Status. There are no operational problems. |

If a message is selected, a window opens with information and corrective actions for the message. Select **OK** to close the window.

TIP A red Message or highlight on the analyzer picture indicates a condition that prevents starting the analyzer.

Jump buttons

Jump buttons provide direct menu access to the most frequently used menus to simplify software navigation.

| Jump Button | Action |
|--------------------------------|--|
| Start Condition | Sets a new data index, the Group of tests in use, the Operator name, and Start Sample numbers. |
| Reagent Management | Displays the R1 and R2 reagent status and cleaning solution status. |
| Analyzer Maintenance | Displays the analyzer and ISE maintenance schedules. Use this menu to start some maintenance procedures and update the schedule when maintenance has been performed. |
| Rack Requisition Sample | Displays sample information and test requisitions for patient samples, calibration, and QC. |
| STAT Status | Displays, starts, and monitors priority STAT samples for analysis from the STAT table. |
| Sample Manager | Views, prints, and batch transfers to host computer reagent blank, calibration, QC, and sample data. |

2.4.4 Menu List Overview

Select **Menu List** to access **Routine**, **Calibration**, **QC**, **Parameters**, **Maintenance**, and **System**:

Figure 2.6



TIP Each menu in the left column has a list of sub-menus in the right column.

2.4.5 User Menu Overview

Select **User Menu**:

Figure 2.7



- A customized (user-defined) list of common menus.
- Customize (user-defined) menu names.
- Select **User Menu**, then select the required menu for direct access.

Refer to 4.10.7 Program a User Menu in the *AU480 User's Guide*, chapter 4 for more information.

2.4.6 Using the Online Help

The **Help** button displays a menu to access user documentation and a maintenance video directory.

The **Alarm List** button provides alarm descriptions and corrective actions.

TIP To stop the audible alarm, select **Alarm Clear**. Select **Alarm Clear** a second time to clear the alarm message from the screen.

Figure 2.8

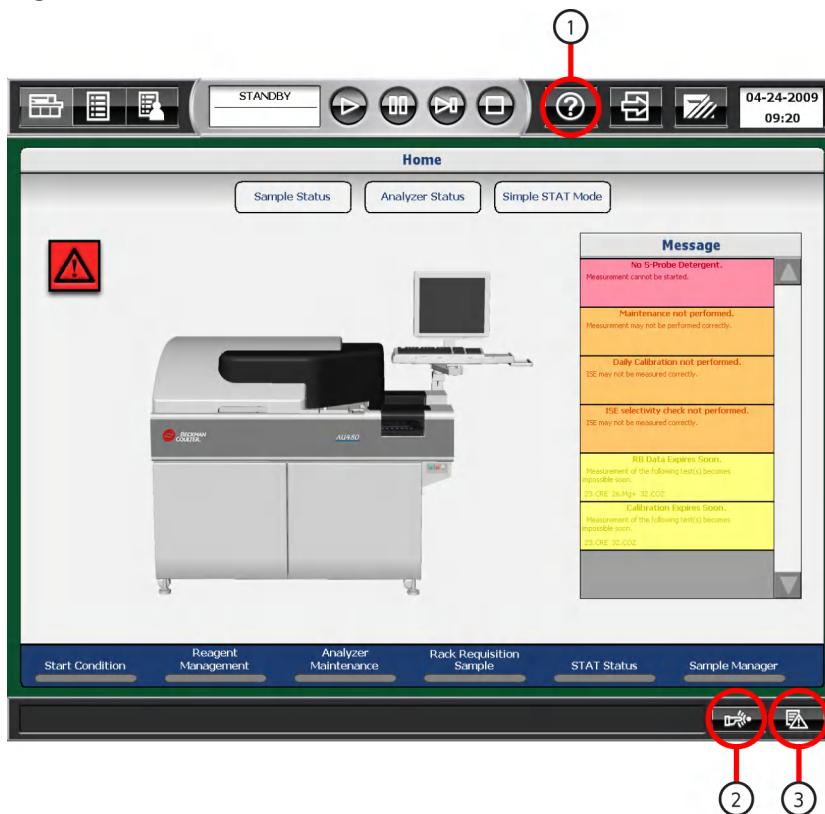

1. Help
2. Alarm Clear
3. Alarm List

There are four types of help as shown in the following table.

| Type of Help | Displayed Description |
|--------------------|--|
| Help | Displays the PDF version of the <i>AU480 User's Guide</i> and Maintenance videos. Select the Help button. The Help button can only be accessed in <i>Warm Up</i> , <i>Standby</i> , or <i>Stop</i> . |
| Alarm List | Displays alarm descriptions and corrective actions. Select Alarm List to display the Alarm List window. Select the Help button on the Alarm List window. |
| Input Help | Displays the range of allowable input values. Move the cursor over the input area to display the pop-up Input Help. |
| Button Help | To determine the function of a button, move the mouse pointer over the button and a pop-up message indicates the function of the button. |

This document does not describe alarms or corrective actions. Select **Alarm List** for alarm help.

2.4.7 Analyzer Modes

The system measure modes displayed in the “Mode Display Area” are shown below.

| Mode | Contents |
|------------------|---|
| <i>Initial</i> | Displays after the green ON button is pressed. The software loads and the hardware initializes. |
| <i>Warm up</i> | After the system initializes, the mode changes to <i>Warm Up</i> for approximately 20 minutes to allow the lamp to warm up and stabilize. |
| <i>Standby</i> | When the system is ready to perform sample analysis, the operation mode changes to <i>Standby</i> . Analysis can be started. |
| <i>Measure 1</i> | <i>Measure 1</i> occurs when the Start button is selected. Racks are present on the rack supply unit, and are moving to the sample aspiration position. |
| <i>Measure 2</i> | <i>Measure 2</i> occurs when there are no more racks on the rack supply unit. To start additional racks, press the Start button. |
| <i>Stop</i> | <i>Stop</i> mode occurs when there is a system error, or when the operator presses the Stop/Standby button. The analyzer cannot be started from <i>Stop</i> mode. To return to <i>Standby</i> mode, press the Stop/Standby button. The mode displays as <i>Reset</i> while the hardware is initializing, then it goes to <i>Standby</i> . All tests in progress must be repeated. |
| <i>Pause</i> | <i>Pause</i> mode occurs when there is a system error, or when the operator selects the Pause button. Analysis can be re-started from <i>Pause</i> by selecting Start button. All tests in progress are completed. |

Processing time

The analysis processing time is defined as the time from aspiration of a sample by the sample probe until the end of measurement. The necessary time for analysis is approximately 8 minutes and 30 seconds.



If a Stop or Emergency Stop occurs, sample can remain in the sample probe, and reagents can remain in the cuvettes. Perform a W1 to clean the sample probe and cuvettes.

For details on how to perform a W1, refer to 8.8.11 Perform a W1 in the User's Guide.

System Outline

2.4 Software Description

This chapter describes how to perform the daily startup procedures.

- 3.1 Start the System
 - 3.1.1 Turn On the System
 - 3.1.2 Set the Start Conditions
- 3.2 Perform Daily Maintenance
- 3.3 Check Analyzer Status
- 3.4 ISE (Option) Startup
 - 3.4.1 Check the ISE Reagent
 - 3.4.2 Perform ISE Daily Maintenance
- 3.5 Check Reagent Status
 - 3.5.1 Check Reagent Quantity and Status
 - 3.5.2 Review Detailed Information
 - 3.5.3 Reagent Replacement
- 3.6 Perform Calibration
 - 3.6.1 Requisition and Perform Calibration from Racks
 - 3.6.2 Requisition and Perform Calibration from the STAT Table
- 3.7 Perform Quality Control (QC)
 - 3.7.1 Requisition and Perform QC from Racks
 - 3.7.2 Requisition and Perform QC from the STAT Table
- 3.8 Start Analysis
 - 3.8.1 Start Rack Analysis
 - 3.8.2 Start STAT Table Analysis

3.1 Start the System

3.1.1 Turn On the System

3.1.2 Set the Start Conditions

3.1.1 Turn On the System

- 1 If the system is already On, proceed to [3.1.2 Set the Start Conditions](#); otherwise, press the green **ON** button. The software loads, and the system initializes. The system is in *Warm up* mode for approximately 20 minutes, then goes to *Standby*.

TIP Automatic On Option

The system can be programmed to automatically turn on at a user-defined time for each day of the week. Refer to 4.10.5 Program the Automatic Startup Function in the *AU480 User's Guide*, chapter 4.

- 2 Log in to the system if necessary.

Figure 3.1

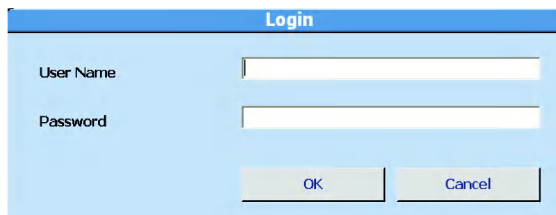

The image shows a 'Login' dialog box with a light blue background. At the top, there is a blue header bar with the word 'Login' in white. Below the header, there are two text input fields. The first is labeled 'User Name' and the second is labeled 'Password'. At the bottom of the dialog, there are two buttons: 'OK' and 'Cancel'.

TIP User Names and Passwords

User Names and Passwords can be programmed and assigned to different security levels for menu access. Refer to 4.11 Program a User Name and Password in the *AU480 User's Guide*. An auto login feature is available if passwords are not in use. Refer to 4.11.3 Security Settings in the *AU480 User's Guide*, chapter 4.

- a. Enter the User Name.
- b. Enter the Password.
- c. Select **OK**. The New Index window opens.

TIP If the system was shut down without performing an End Process, the System Start window to retrieve the Database appears. Select **OK**.

The New Index window is only displayed at the time of system startup.

Figure 3.2

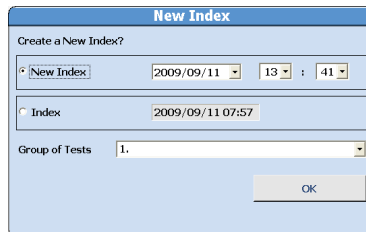

-
- 3** Select the Index and Group of Tests as needed.
 - a. Select **New Index** to create a new index, or **Index** to return to the previous index.
 - b. Select the group of tests to process from the "Group of Tests" drop-down list.
 - c. Select **OK**. **Home** displays.
-

3.1.2 Set the Start Conditions

This menu is used to create a data index, select a Group of tests, and input the operator name.

An index is a data file identified by the date and time. Create a new index daily, each shift, or as needed.

1 Select **Home > Start Condition**.

2 Select **Edit (F1)**.

Figure 3.3

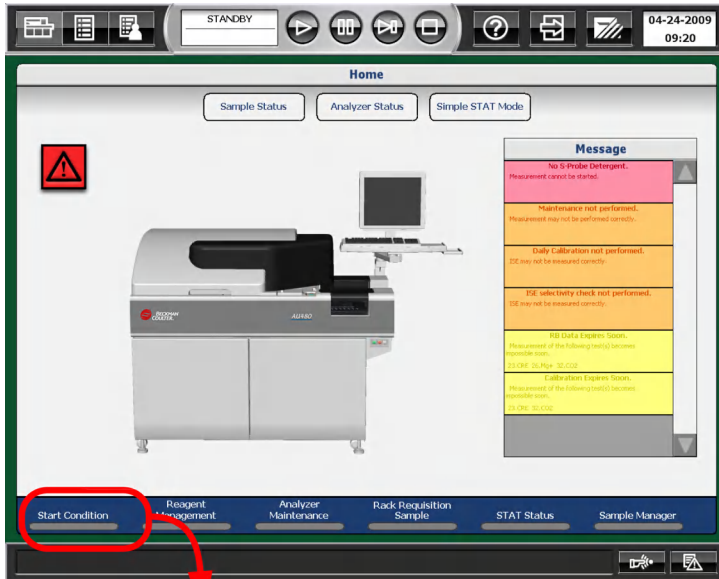

Routine | **Start Condition**

Current Index: 2/1/2013 14:15

Group of Tests: 2.BR/CAP/VC

Operator Name: SYSTEM

Start Sample No.

| | Serum | Urine | Other-1 | Other-2 | |
|--------------------|-------|-------|---------|---------|--|
| Routine | 0001 | 0041 | 0001 | 0001 | |
| Emergency | 001 | 001 | 001 | 001 | |
| STAT | | | | | |
| Repeat | 0001 | 0001 | 0001 | 0001 | |
| Repeat / Emergency | 001 | 001 | 001 | 001 | |
| Repeat / STAT | | | | | |

Remaining Samples: 9959

Calibration Selected

Rack Status: Selected

STAT: Not Selected

Online Status:

Disable:

TIP Index

Displays the current index.

Group of Tests

Selects the group of on-board tests to perform.

Operator Name

Enter the operator name, or select the **Select** button to select a name from the comment master list.

Start Sample No.

Displays the next sample number to be processed on the analyzer for each sample type and kind. When a new index is created, the Start Sample Numbers go to the default sample numbers, typically 0001.

- 3 Select **New Index** or **Date Index (F8)**. If **Date Index (F8)** is selected, the Date Index window opens.

Figure 3.4

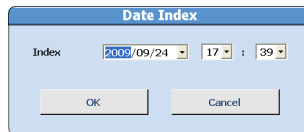

- a. Select the date and time from the "Index" drop-down list.
- b. Select **OK**.

- 4 Select a group of tests to process from the "Group of Tests" drop-down list.

- 5 Enter the operator name in Operator Name (optional).

- 6 Verify Start Sample No. is 0001, or the default start number for each sample type and kind.

- 7 Select **Confirm (F1)**. The Start Condition window displays "Create a New Index?".

Daily Startup

3.1 Start the System

8 Select **OK**. The programming is registered.

3.2 Perform Daily Maintenance

Perform the following daily maintenance to ensure system performance and safety:

- Inspect the syringes for leaks
- Inspect the wash solution roller pump for leaks
- Inspect, clean, and prime the sample probe, reagent probe, and mix bars
- Inspect the wash solution and replenish as needed
- Inspect the printer (optional) and paper
- Replace the deionized (DI) water or diluent in the pre-dilution bottle
- Prepare the sample probe wash solution
- Inspect the stability of the upper cover

For details on performing daily maintenance, refer to 8.3 Daily Maintenance in the *AU480 User's Guide*, chapter 8.



To prevent injury or infection, be sure to wear protective gloves and other protective equipment when performing maintenance.

For additional protection, observe the WARNING and CAUTION statements in the *AU480 User's Guide*.

3.3 Check Analyzer Status

Check **Analyzer Status** to display a color-coded overview of the system, and the temperatures of the incubator and reagent refrigerator. The STAT table, DI water tank, wash solution tanks, waste tanks, printer, and LIS communication are monitored.

| Color | Status |
|------------------|--|
| Blue | No errors. |
| Yellow or Orange | Non-fatal error. The analyzer can be started. |
| Red | Fatal error. The analyzer cannot be started. |

The ISE unit and reagents are monitored when the ISE unit is installed.

Review Analyzer Status:

Select **Home > Analyzer Status**.

Figure 3.5

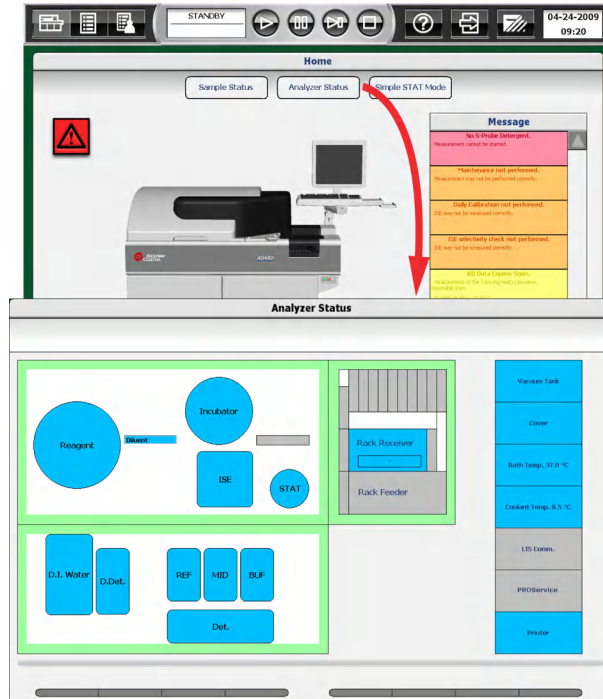

For details on **Analyzer Status**, refer to 7.1.4 Analyzer Status Menu in the *AU480 User's Guide*, chapter 7.

3.4 ISE (Option) Startup

Perform ISE startup and daily maintenance procedures.

[3.4.1 Check the ISE Reagent](#)

[3.4.2 Perform ISE Daily Maintenance](#)

3.4.1 Check the ISE Reagent

1 Open the left front door of the analyzer.

2 Verify the ISE reagents are within the 90-day onboard stability. Verify the solution level is sufficient for typical daily analysis, or above the ISE Reagent Short notification alarm (5.2 cm above the bottom of the bottle). After the alarm, approximately 180 samples of MID Standard solution, 600 samples of Reference solution, and 240 samples of Buffer solution can be dispensed. Replace the bottle if necessary. **NEVER ADD NEW REAGENT TO EXISTING BOTTLES.**

- Buffer solution bottle
- MID Standard solution bottle
- Reference solution bottle

TIP Verify there is sufficient reagent before starting analysis. If a reagent becomes empty during *Measure*, it is necessary to Stop the analyzer, replenish and prime the new reagent, and calibrate the ISE for all sample types in use.

Figure 3.6

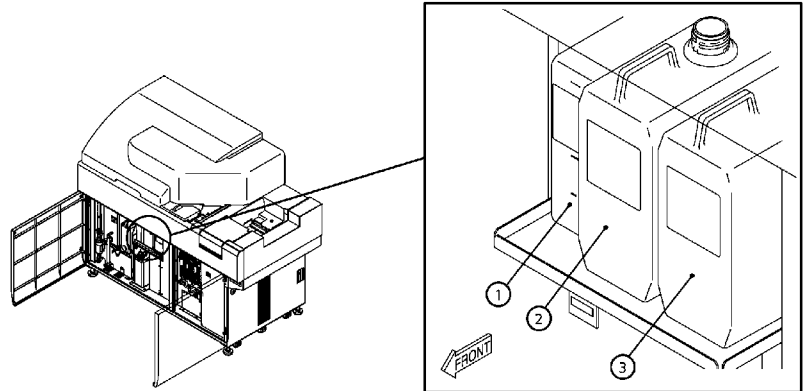

1. REF solution bottle
2. MID solution bottle
3. Buffer solution bottle

For information about loading ISE reagents, refer to 8.19.5 Replacing ISE Reagents in the *AU480 User's Guide*, chapter 8.

-
- 3** Close the left front door of the analyzer.
-

3.4.2 Perform ISE Daily Maintenance

Perform ISE Daily Maintenance to ensure system performance and safety.

- ISE Cleaning
- ISE Calibration

For details on performing ISE daily maintenance, refer to 8.12 ISE Daily Maintenance in the *AU480 User's Guide*, chapter 8.



To prevent injury or infection, be sure to wear protective gloves and other protective equipment when performing maintenance.

For additional protection, observe the WARNING and CAUTION statements in the *AU480 User's Guide*.

3.5 Check Reagent Status

3.5.1 Check Reagent Quantity and Status

3.5.2 Review Detailed Information

3.5.3 Reagent Replacement

3.5.1 Check Reagent Quantity and Status

View the status of the reagents currently onboard the analyzer. Perform a reagent check to update the reagent status when reagents have been loaded or unloaded, and following an **End Process** or Emergency Stop.

- 1 Select **Home > Reagent Management > Main**.

Figure 3.7

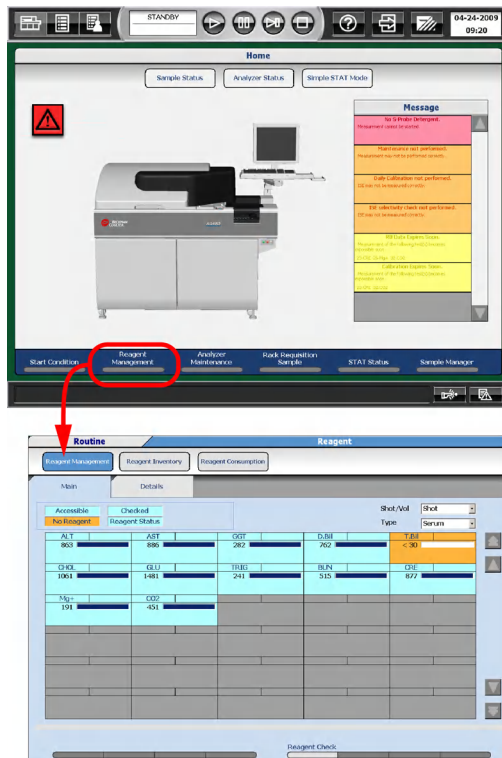

2 Select a sample type from the “Type” drop-down list.

3 Select **Reagent Check (F5)**.

4 Select one of the Check methods.

Figure 3.8

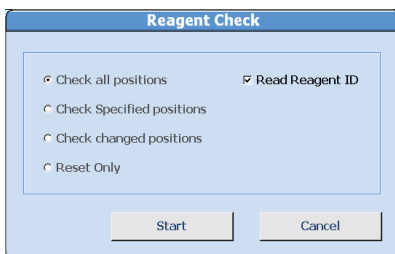

TIP Reagent Check (F5) options:

- **Check all positions**
Checks the remaining volume of reagent at all positions, including the bottle positions outside of the reagent refrigerator. Select this check as part of the daily startup, when changing any parameter, changing the Group, and loading numerous reagents.
- **Check specified positions**
Checks the remaining volumes of reagent at the specified positions.
Select this check when replacing a reagent bottle.
- **Check changed positions**
Checks the remaining reagent for any reagent ID that is new or has been moved since the previous reagent check.
- **Reset Only**
Select this when the reagent refrigerator cover was only opened and closed without changing any reagent. The reagent volume check is not performed, only the status is changed from “Unchecked” to “Checked.”
- **Read Reagent ID**
Select this if the reagent barcode is to be read.

TIP If contamination prevention parameters are programmed, the prevention parameters are applied during a reagent check.

5 Select **Start**. Reagent check starts. During the reagent check, “Checking” is displayed in red on the screen, and the bar graph displays the reagent check progress. When the check is complete, “Checked” is displayed in blue.

6 View the Reagent Status box in the upper left hand corner of the **Main** tab. The Display and Background color indicate the status of the reagent refrigerator and the reagent check. Review Comments in the **Details** tab if yellow, orange, or red is present.

Refer to section [3.5.2 Review Detailed Information, Reagent Status](#) for a description of Reagent Status.

Figure 3.9

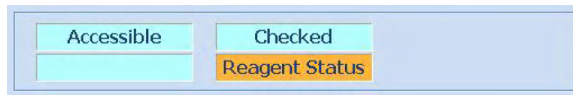

7 View the status of each individual test displayed on the **Main** tab. Verify that required reagents are present and that all reagents have sufficient volume. Identify reagents that need to be loaded.

Figure 3.10

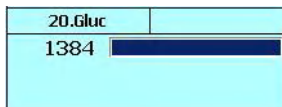

Refer to section [3.5.2 Review Detailed Information](#) for a description of Test Status.

- 8 Select **Details**. Verify the Onboard Remaining, RB Stability Remaining, and Cal Stability Remaining time is sufficient for the run. Review the Comments and perform necessary corrective actions.

Figure 3.11

| Pos. | Test Name | R1/R2 | Shots | Onboard Remaining | RB Stability Remaining | CAL Stability Remaining | Expiration | Lot No. | Bottle No. | Seq. | Comment |
|------|-----------|----------|-------|-------------------|------------------------|-------------------------|------------|---------|------------|------|-----------------------|
| 11 | CaHrs | R1(R1-1) | 2221 | 780 | 0% | 0% | 12/1/2014 | 3315 | 2684 | 1 | CAL Stability Expired |
| 16 | Ca-Dpe | R1(R1-1) | 3902 | 200 | 0% | 0% | 9/1/2013 | 3196 | 0124 | 1 | CAL Stability Expired |
| 18 | Ca-Dpe | R2(R2-1) | 938 | 200 | 0% | 0% | 9/1/2013 | 3196 | 0236 | 1 | CAL Stability Expired |
| 13 | Uu | R1(R1-1) | 931 | 180 | 0% | 0% | 6/1/2014 | 3298 | 0935 | 1 | CAL Stability Expired |
| 15 | Uu | R2(R2-1) | 991 | 180 | 0% | 0% | 6/1/2014 | 3298 | 0962 | 1 | CAL Stability Expired |
| 4 | Mg+ | R1(R1-1) | 127 | 30 | 0% | 0% | 8/1/2014 | 3516 | 8664 | 1 | CAL Stability Expired |
| 24 | LDH | R1(R1-1) | 309 | 180 | 0% | 0% | 3/1/2014 | 2968 | 0640 | 1 | CAL Stability Expired |
| 26 | LDH | R2(R2-1) | 309 | 180 | 0% | 0% | 3/1/2014 | 2968 | 0684 | 1 | CAL Stability Expired |
| 20 | Uu-OB | R1(R1-1) | 869 | 180 | 0% | 0% | 7/1/2013 | 3517 | 0495 | 1 | CAL Stability Expired |
| 21 | Uu-OB | R2(R2-1) | 539 | 180 | 0% | 0% | 7/1/2013 | 3517 | 0498 | 1 | CAL Stability Expired |
| 30 | UuN | R1(R1-1) | 1002 | 180 | 0% | 0% | 7/1/2013 | 3366 | 0927 | 1 | CAL Stability Expired |
| 32 | UuN | R2(R2-1) | 1002 | 180 | 0% | 0% | 7/1/2013 | 3366 | 1003 | 1 | CAL Stability Expired |
| 2 | Any | R1(R1-1) | 40 | 180 | | | 12/1/2013 | 3458 | 1301 | 1 | No RB Data |
| 12 | Creat | R1(R1-1) | 88 | 30 | 0% | 0% | 7/1/2014 | 3365 | 4113 | 1 | CAL Stability Expired |
| 14 | Creat | R2(R2-1) | 79 | 30 | 0% | 0% | 7/1/2014 | 3365 | 4114 | 1 | CAL Stability Expired |
| 10 | MP | R1(R1-1) | 79 | 780 | | | 7/1/2013 | 3349 | 1419 | 1 | |
| 77 | Uu | | | | | | | | | | |

- 9 Add new reagents as needed based on steps 6 to 8.

For details on loading new reagents, refer to [3.5.3 Reagent Replacement](#).

- 10 If reagent is short or empty, load additional reagent(s) and perform a reagent check again.

3.5.2 Review Detailed Information

Reagent Status

Home > Reagent Management > Main

Figure 3.12

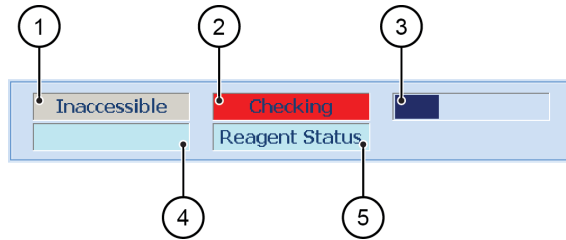

| | Display | Background Color | Description |
|-----|----------------|------------------|--|
| (1) | Accessible | Light blue | Accessible displays if reagent bottles can be loaded. Inaccessible displays if reagent bottles cannot be loaded. |
| | Inaccessible | Red | |
| (2) | Unchecked | Red | Displays status of reagent check. |
| | Checking | Red | |
| | Checked | Light blue | |
| (3) | Progress bar | - | Displays the progress of reagent check. Display appears only when checking. |
| (4) | No Reagent | Orange | A reagent assigned to the Group is missing from the reagent refrigerator, the on-board stability is expired, the reagent is expired, or the bottle is empty. |
| | Reagent short | Yellow | |
| | No display | Light blue | |
| (5) | Reagent Status | Orange | Displays an error level of reagents in the Reagent 1 refrigerator |
| | | Yellow | |
| | | Light blue | |

Test Status

Home > Reagent Management > Main

Figure 3.13

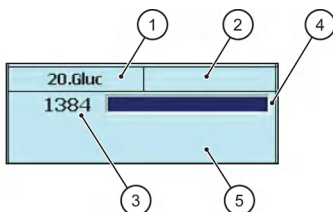

| | Display | Display Color | Description |
|-----|-------------------------------------|---------------|---|
| (1) | Test name 1 | - | Displays test names in the output order that has been set in the Group. ISE and non dedicated LIH reagents are not displayed. |
| (2) | Test name 2 | - | In case of 2-tests/1-reagent ^a , another test name is displayed. |
| (3) | Number of shots or remaining volume | - | The number of shots (tests) remaining or volume in mL. Select the Shot/Vol. drop down to change the display. Select the Type drop down to view the shots or volume for the specified sample type. |
| (4) | Indicator | - | Displays the remaining reagent volume. If more than one bottle is on the system, the total reagent volume displays. The length of the bar displays the maximum number of tests calculated in Reagent Inventory , and estimates the reagent consumption required for the day. Reagent quantity indicator bar(s): The R1 indicator bar displays on top of the R2 indicator bar if Advanced Calibration is set to No and Multi Reagent Switch is set to No in Parameters . If Advanced Calibration is set to Yes and Multi Reagent Switch is set to Yes in Parameters (as in most cases), there is a single indicator bar even for an R1/R2 assay. Beckman Coulter recommends programming Multi Reagent Switch to Yes. |
| (5) | Background color | Orange | A reagent assigned to the Group is missing from the R1 or R2, the on-board stability is expired, the reagent is expired, or the bottle is empty. |
| | | Yellow | Reagent volume is short (low). |
| | | Light Blue | Required reagents are set. |
| | | Gray | The test operation is programmed to No for the sample type displayed from the Reagent Management > Main "Type" drop-down list. Change the sample type from the "Type" drop-down list to view the background color of the reagent. |

- a. 2-tests/1 reagent means the same reagent is used for two tests. Program this option in **Menu List > Parameters > Common Test Parameters > Test Name** by assigning the same reagent ID for both tests.

TIP When the analyzer has turned on after an **End Process**, all tests initially show a pre-programmed value, for example "< 30 shots," without a volume indicator bar. Select **Reagent Check (F5) > Check all positions** to determine the number of shots (tests) remaining.

Details Tab

Home > Reagent Management > Details

Figure 3.14

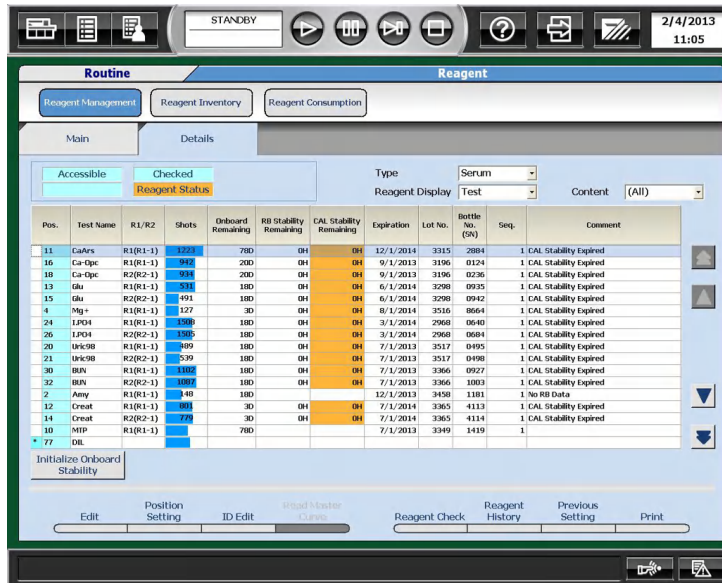

| Item | Description |
|------------------|--|
| Type: | Select Serum, Urine, Other-1, Other-2. |
| Reagent Display: | Select Test (displayed by test) or Position (displayed by position). |
| Content: | Select All or a specific test. |
| Pos.: | R1 or R2 reagent position. |
| R1/R2: | Select R1 or R2. |

Daily Startup

3.5 Check Reagent Status

| Item | Description |
|-------------------------------|--|
| Shots: | Number of tests remaining in the bottle. |
| Onboard Remaining: | Hours (H) or Days (D) remaining until the reagent on-board stability expires. |
| RB Stability Remaining: | Hours (H) or Days (D) remaining until the reagent blank stability expires. |
| Cal Stability Remaining: | Hours (H) or Days (D) remaining until the calibration stability expires. |
| Expiration: | The expiration date of the reagent lot number. |
| Bottle No. (SN): | A unique 4-digit number to identify each bottle of reagent. |
| Seq.: | Sequence number 1-5 of the same reagent in the R1/R2. |
| Comment: | A caution or error message for the reagent. |
| Edit (F1) | Edits the test name, lot number, bottle number, and bottle size for fixed reagents. |
| Position Setting (F2) | Assigns a position as Reagent ID or Fixed. When the position is fixed, an * appears to the left of the Position number. |
| ID Edit (F3) | Edits the 20-digit reagent ID. Use this option to edit the reagent ID after a reagent ID read error. |
| Read Master Curve (F4) | Scans the 2-dimensional reagent ID for master curve assays. |
| Reagent Check (F5) | Performs the reagent check. |
| Reagent History (F6) | Displays the lot number, bottle number, position, and on-board stability (hours) for 100 lines of data for R1 and R2 reagents. |
| Previous Setting (F7) | Displays the most recent reagent bottle position. Available only in <i>Pause</i> mode. |
| Print (F8) | Prints all the Details tab information. |

TIP The time remaining displays in hours (H) up to 72 hours, and days (D) over 72 hours.

If two tests are programmed to use one reagent, the RB Stability Remaining and Cal Stability Remaining display as lower Test No./higher Test No.

3.5.3 Reagent Replacement

If the reagent volume is insufficient, on-board stability has expired, or the reagent is expired, remove the old reagent bottles and replace them with a new set.

 **CAUTION**

Never add new reagent to existing bottles.

Reagent preparation

Most Beckman Coulter reagents are liquid and ready to be placed in the reagent refrigerator after removing the cap. If a Beckman Coulter or other manufacturer's reagent requires preparation, refer to the reagent specific IFU before loading the reagent in the reagent refrigerator. Three types of reagent bottles can be used with this system:

- 60 mL reagent bottle
- 30 mL reagent bottle
- 15 mL reagent bottle

Setting reagents into the reagent refrigerator

 **WARNING**

- **Condensation can form on the walls of the reagent compartment, in the bottle neck, or on the barcode label on the bottle. If the bottle neck has condensation, a level detection error can occur. If the bottle surface with the barcode label has condensation, detection of the bottle can fail. If condensation is present, remove the condensation using a dry paper towel.**
- **When using 15 mL bottles, verify they are placed on the reagent tray with the barcode facing out. Setting the bottles incorrectly may damage the bottle and reagent probe.**
- **If bubbles are present in the bottles, correct analysis may not occur. Check the bottles for bubbles, and remove any bubbles before placing bottles in the reagent refrigerator.**



CAUTION

- **15 mL and 30 mL bottles require adapters to hold them securely in position in the reagent refrigerator. Verify adapters are used and securely in place.**
- **A maximum of 76 bottles can be placed in the reagent refrigerator. There are thirty eight 60 mL bottles positions available.**

Replace a reagent

- 1 Open the front main cover.
- 2 Lift and remove the reagent refrigerator cover.

Figure 3.15

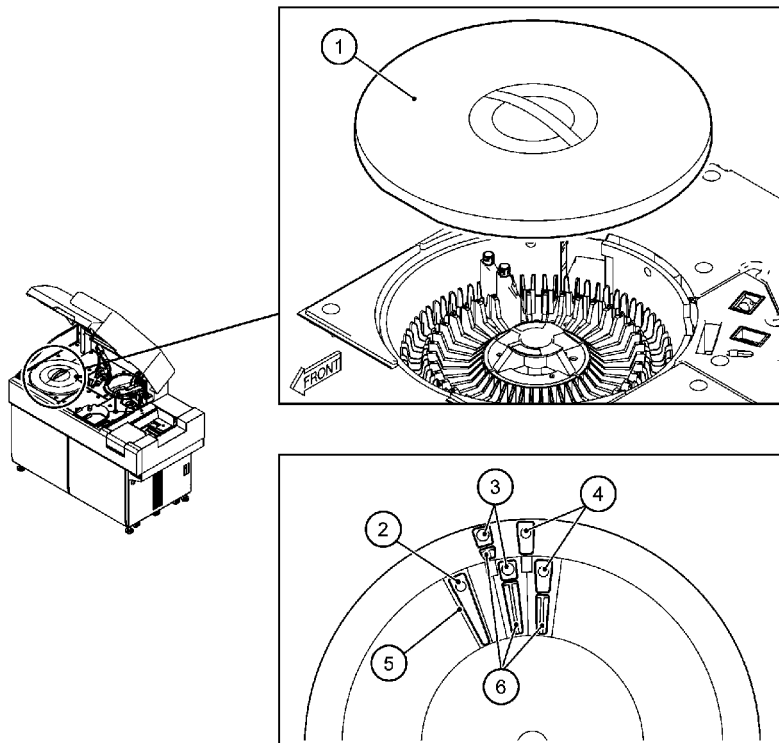

- | | |
|-------------------------------|---------------------------|
| 1. Reagent refrigerator cover | 4. Reagent bottle (30 mL) |
| 2. Reagent bottle (60 mL) | 5. Partition plate |
| 3. Reagent bottle (15 mL) | 6. Adaptor |

3 Place R1 and R2 bottles in the reagent refrigerator.

TIP Remove the cap from the reagent bottle before placing the bottle in the reagent refrigerator.

If the bottle has a reagent ID, it can be placed in any available (not fixed) position in the reagent refrigerator.

If the bottle does not have a reagent ID, place it in the appropriate fixed position. Fixed positions are indicated by a blue "*" to the left of the position column on the Details tab. To assign a reagent without a reagent ID to a position, refer to 7.4.1 Fix (Assign) a Reagent Position in the *AU480 User's Guide*, chapter 7.

4 Replace the reagent refrigerator cover.

5 Close the main cover.

6 Select **Home > Reagent Management**.

7 Select **Reagent Check (F5)**. The Reagent Check window opens.

Figure 3.16

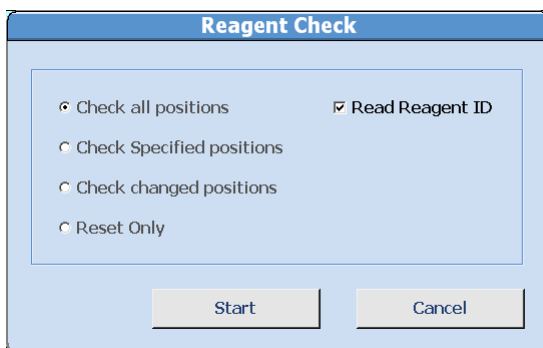

-
- 8** Select the check method to perform. Select **Start** to begin the reagent check. Review **Main** and **Detail** to verify the results.



CAUTION

When the barcode label on a reagent bottle is dirty or has moisture on it, barcode reading errors can occur. Check the barcode label of the reagent bottle.

If the barcode label is dirty or has moisture adhering to it, wipe it off.

If the barcode cannot be read even after wiping off dirt or moisture, enter the barcode ID manually. For details on ID editing, refer to [6.10 Edit a Reagent ID](#) in [CHAPTER 6](#).

For precautions on filling bottles with reagent, refer to 5.5.3 Reagent Replacement in the *AU480 User's Guide*, chapter 5.

3.6 Perform Calibration

[3.6.1 Requisition and Perform Calibration from Racks](#)

[3.6.2 Requisition and Perform Calibration from the STAT Table](#)

Requisition reagent blanks and calibrations. Automatic reagent blank and calibration requisition occurs with the following conditions:

- Reagent blank or calibration Expired
- Reagent blank or calibration Expired Soon
- New bottle or lot number of reagent if Advanced Calibration is in use
- Reagent blank or calibration failed

TIP The automatic reagent blank or calibration requisition does not occur until after a reagent check is performed.

Review the Comments in **Reagent Management > Details** to determine what tests need to be calibrated.

TIP Calibration consists of a reagent blank and calibration. Calibration can be performed from the blue and yellow racks or the STAT table.

The STAT table has numerous options for calibrating from the STAT table, including calibrator ID, and fixed, variable, or free calibrator positions on the table. Refer to 4.5.4 STAT Table Calibration Menu in the *AU480 User's Guide*, chapter 4. Contact Beckman Coulter Technical Services for information on programming the STAT table for calibration.

The most common method to calibrate is from the yellow racks. Refer to [3.6.1 Requisition and Perform Calibration from Racks](#).

3.6.1 Requisition and Perform Calibration from Racks

- 1 Select **Home** > **Rack Requisition Sample** > **Calibration**.

Figure 3.17

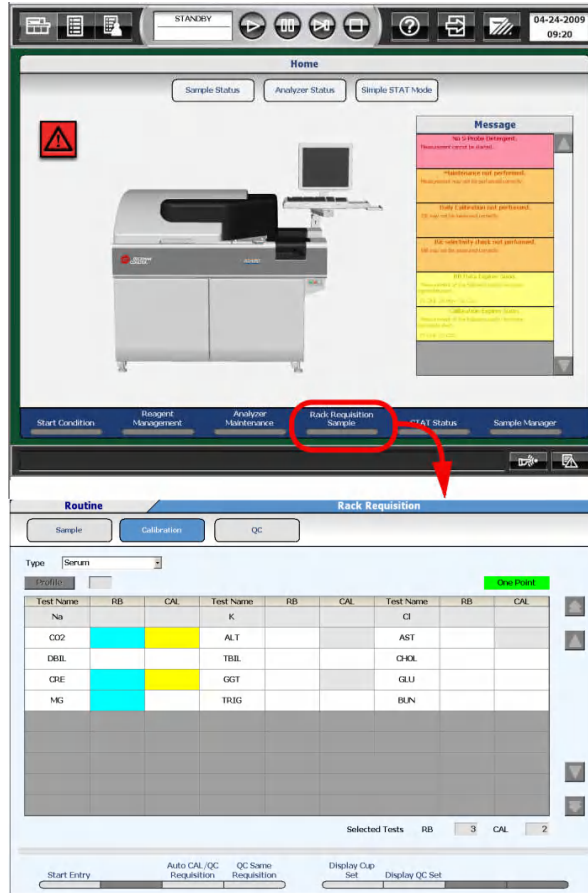

2 Select the sample type from the "Type" drop-down list.

3 Select **Auto Cal/QC Requisition (F3)** to select the automatic requisition.

This step is not required if a reagent check was just performed. A reagent check selects and displays the automatic requisition in **Calibration**.

4 If the analyzer automatic requisition is correct, proceed to step 7.

TIP Automatic reagent blank and calibration requisition occurs in the following conditions:

- Reagent blank or calibration Expired
- Reagent blank or calibration Expired Soon
- New bottle or lot number of reagent if Advanced Calibration is in use
- Reagent blank or calibration failed

Tests display with a blue box in the RB column when requisitioned for reagent blank. Tests display with a blue box in the RB column and a yellow box in the CAL column when requisitioned for calibration.

Select **QC Same Requisition (F4)** to requisition the same tests for QC analysis as the tests selected for reagent blank and calibration analysis. Select **Display QC Set (F6)** to display the QC material, QC racks, and QC positions required based on the QC requisition.

In **Reagent Management**, any of the **Reagent Check (F5)** options, including Reset, resets the calibration requisitions to the analyzer automatic requisitions.

A one-point calibration correction can be requisitioned and performed if the test is a multi-point calibration, and 1-Point Calibration Point is programmed in Calibration Parameters. Refer to 4.5.3 Calibration Specific Menu in the *AU480 User's Guide*, chapter 4.

-
- 5** Select **Start Entry (F1)**.
- To select a profile, select **Profile** to open the Profile window and select a profile, then select **OK**.
 - To select a specific test(s), select from the RB or CAL column to the right of the test name. Selecting from the RB column requisitions only a reagent blank. Selecting from the CAL column requisitions a reagent blank and calibration.
 - Select **Individual Requisition (F3)** to requisition sequenced bottles (1, 2, 3, 4, 5) of the same test. Select a specific test and bottle sequence by selecting the RB or CAL column, **Select All by Test** (requisitions all bottles of the selected test), or **Select All** (requisitions all bottles for all tests). Select **Close** to register the requisition, or **Cancel** to cancel the requisition.

TIP Calibration profiles must be programmed in **Menu List > Parameters > Common Test Parameters > Profile > RB/Calibration** before a profile is available to requisition. Refer to 4.2.2 Profile Menu in the *AU480 User's Guide* for more information. A maximum of 99 different profiles can be programmed, including daily, weekly, and monthly calibration requirements.

A test must be programmed for Advanced Calibration in **Menu List > Parameters > Calibration Parameters > Calibration Specific** before it is available to requisition by bottle sequence number in Individual Requisition (F3). Refer to 4.5.3 Calibration Specific Menu in the *AU480 User's Guide* for more information.

-
- 6** Select **Entry (F1)** to register the requisition. Select **Exit (F2)** to cancel the requisition.

-
- 7** Select **Display Cup Set (F5)** to view the reagent blank, calibrator(s), racks, and positions required for reagent blank and calibrator(s). Load the reagent blanks and calibrators according to the list in the correct blue and yellow racks. Select **Close** to close the window.

TIP In **Display Cup Set (F5)**, the Volume (μL) is the sample volume required based on the requisitioned tests. The dead volume is not included.

If calibrator barcode operation is in use, the Rack No. in **Display Cup Set (F5)** displays as 000x.

To requisition QC the same as the calibration requisition, select **QC Same Requisition (F4)**.

8 Load the racks on the rack supply unit. Load the blue rack first, followed by the yellow rack(s).

9 Select **Start**.

3.6.2 Requisition and Perform Calibration from the STAT Table

TIP Requisition calibrators before calibrating from the STAT table. Calibration requisitions are not automatic from the STAT table.

Tests display with a blue box in the RB column when requisitioned for reagent blank. Tests display with a blue box in the RB column and a yellow box in the CAL column when requisitioned for calibration.

- 1 Select Home > **STAT Status** > **Calibration**.

Figure 3.18

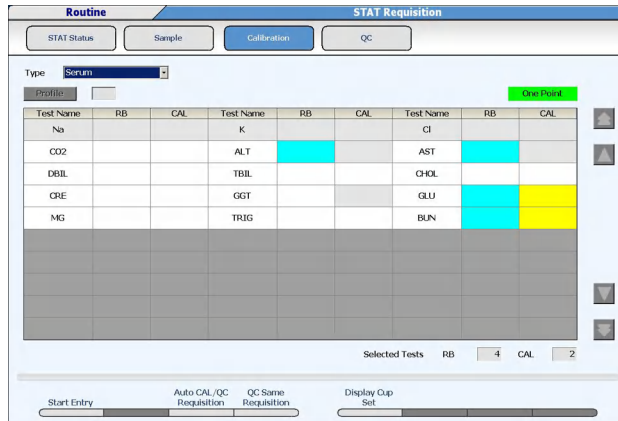

- 2 Select a sample type from the "Type" drop-down list.
- 3 Select **Auto CAL/QC Requisition (F3)** to requisition the automatic analyzer calibration requisition. The automatic analyzer calibration requisition is expired calibrations, calibration expires soon, new bottle numbers or lot numbers of reagent depending on Advanced Calibration programming, or failed reagent blank/calibrations. This also automatically requisitions the same tests for QC analysis in the QC requisition menu.
- 4 Select **Start Entry (F1)** to requisition calibrators.
 - Select **Profile** to open the Profile window and select a profile, then select **OK**.
 - To select a specific test(s), select from the RB or CAL column to the right of the test name. Selecting from the RB column requisitions only a reagent blank. Selecting from the CAL column requisitions a reagent blank and calibration.

- 7 Load the required reagent blank and calibrators on the STAT table according to the CAL/QC/RB Position window. Use the TABLE ROTATION/DIAG button to rotate the table if necessary. Select **Print** to print a list of the CAL/QC/RB Position window contents, or **Close** to close the window.
 - If the Calibrator Barcode Operation is not enabled, place the calibrators in the correct positions according to the "Pos.".
 - If the Calibrator Barcode Operation is enabled with Fixed Calibrator positions, place the calibrators in any Calibrator position (listed under "Kind").
 - If the STAT table is programmed for Free positions (listed under "Kind"), place the barcoded calibrator in any position.
-
- 8 Select **STAT Status > STAT Start (F1)**. Review the Error List in the STAT Start window. Verify the required reagent blank and calibrators are on the STAT table.

Figure 3.20

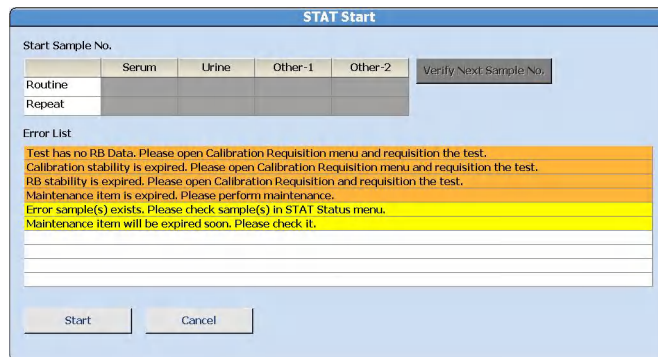

- 9 Select **Start** to initiate the automatic STAT table check (detects reagent blank and calibrators) or **Cancel** to take corrective actions.

-
- 10** If there are no errors specific to the STAT table after the STAT table check, analysis starts. If there are STAT table errors, review the errors in the STAT Start window. Select **Start** to begin analysis, or **Cancel** to perform corrective actions.
-

3.7 Perform Quality Control (QC)

3.7.1 Requisition and Perform QC from Racks

3.7.2 Requisition and Perform QC from the STAT Table

Quality control analysis is used for confirming the system performance. It is necessary for all diagnostic equipment.

Check the performance of the AU480 regularly by analyzing QC samples. Each laboratory should establish its own control frequency. QC samples should be tested each time patient samples are tested and each time calibration is performed. If any trends or sudden shifts in values are detected, review all operating parameters.

Each laboratory should also establish guidelines to ensure corrective action if controls do not recover within the specified limits.

TIP QC can be performed from the green racks or the STAT table.

The STAT table has numerous options for performing QC from the STAT table, including control ID, and fixed, variable, or free control positions on the table. Refer to 4.6.3 STAT Table QC Menu in the *AU480 User's Guide*, chapter 4. Contact Beckman Coulter Technical Services for information on programming the STAT table for controls.

The most common method to perform QC is from the green racks. Refer to 5.7.1 Requisition and Perform QC from Racks in the *AU480 User's Guide*, chapter 5.

TIP A default QC requisition can be programmed in **Menu List > Parameters > Common Test Parameters > Profile > QC** for each sample type and Group in use. Refer to 6.2.3 Create a QC Profile in the As Needed Tasks for more information. Specific profile numbers are designated for each sample type and Group:

| Profile Number | Sample Type/Group |
|-----------------------|--------------------------|
| 87 | Serum/1 |
| 88 | Serum/2 |
| 89 | Serum/3 |
| 90 | Urine/1 |
| 91 | Urine/2 |
| 92 | Urine/3 |
| 93 | Other-1/1 |
| 94 | Other-1/2 |
| 95 | Other-1/3 |
| 96 | Other-2/1 |
| 97 | Other-2/2 |
| 98 | Other-2/3 |

TIP The default QC profile is automatically requisitioned.

In **Reagent Management**, if any of the **Reagent Check (F5)** options are performed, the QC requisitions are reset back to the default.

3.7.1 Requisition and Perform QC from Racks

- 1 Select **Home** > **Rack Requisition Sample** > **QC**.

Figure 3.21

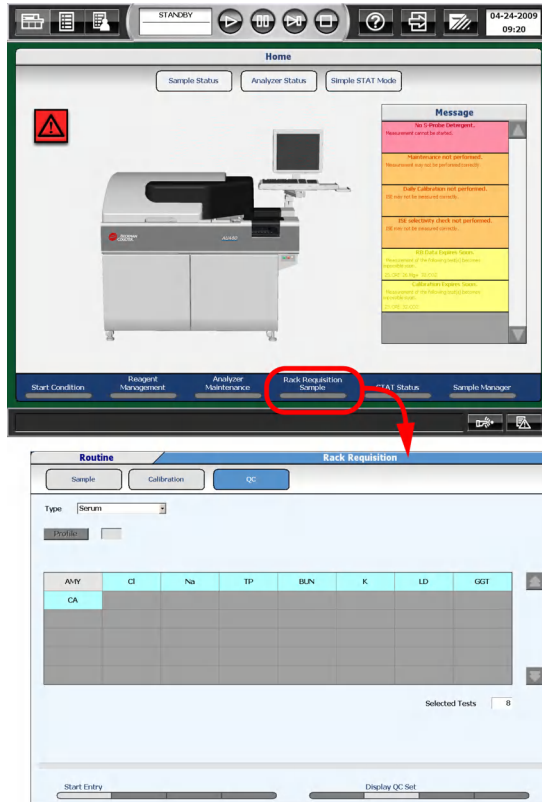

- 2 Select the sample type from the "Type" drop-down list.
- 3 If the default QC profile displayed is correct, proceed to step 6.

TIP QC profiles must be programmed in **Menu List > Parameters > Common Test Parameters > Profile > QC** before a profile is available to requisition. Refer to 4.2.2 Profile Menu in the *AU480 User's Guide* for more information. A maximum of 98 different profiles can be programmed, including the default profiles.

A test must be programmed for Advanced Calibration in **Menu List > Parameters > Calibration Parameters > Calibration Specific** before it is available to requisition by bottle sequence number in Individual Requisition (F3). Refer to 4.5.3 Calibration Specific Menu in the *AU480 User's Guide* for more information.

-
- 4** Select **Start Entry (F1)**.
- a. Select **Profile** to open the Profile window and select a profile, then select **OK**.
 - b. Select a test(s) to requisition QC (blue highlight) or de-select QC (no blue highlight).
 - c. Select **Individual Requisition (F3)** to requisition sequenced bottles (1, 2, 3, 4, 5) of the same test. Select a specific test and bottle sequence, **Select All by Test** (requisitions all bottles of the selected test), or **Select All** (requisitions all bottles for all tests). Select **Close** to register the requisition, or **Cancel** to cancel the requisition.

-
- 5** Select **Entry (F1)** to register the QC requisition. Select **Exit (F2)** to cancel the requisition.

-
- 6** Select **Display Cup Set (F6)** to view the control(s), racks, and positions required for the control(s). Load the controls according to the list in the correct green racks. Select **Close** to close the window.

TIP In **Display Cup Set (F6)**, the Volume (μL) is the sample volume required based on the requisitioned tests. The dead volume is not included.

If QC barcode operation is in use, the Rack No. in **Display Cup Set (F5)** displays as 000x.

7 Load the racks on the rack supply unit.

8 Select **Start**.

3.7.2 Requisition and Perform QC from the STAT Table

TIP Requisition QC before QC analysis from the STAT table. QC requisitions are not automatic from the STAT table.

1 Select **Home > STAT Status > QC**.

Figure 3.22

The screenshot shows the 'STAT Requisition' window. At the top, there are tabs for 'Routine' and 'STAT Requisition'. Below the tabs are buttons for 'STAT Status', 'Sample', 'Calibration', and 'QC'. The 'Type' dropdown is set to 'Serum'. There is a 'Profile' button and a checkbox. Below this is a table with columns for ALT, AST, CO2, CHOL, GLU, CRE, GGT, and BUN. The first row has 'TRIG' under ALT. Below the table is a 'Selected Tests' field showing '9'. At the bottom, there are buttons for 'Entry', 'Exit', and 'Individual Requisition'.

| ALT | AST | CO2 | CHOL | GLU | CRE | GGT | BUN |
|------|-----|-----|------|-----|-----|-----|-----|
| TRIG | | | | | | | |
| | | | | | | | |
| | | | | | | | |
| | | | | | | | |

2 Select a sample type from the "Type" drop-down list.

3 Select **Start Entry (F1)** to requisition QC.

- Select Profile to open the Profile window and select a profile, then select OK.

- 6** Load the required QC on the STAT table according to the CAL/QC/RB Position window. Use the TABLE ROTATION/DIAG button to rotate the table if necessary. Select **Print** to print a list of the CAL/QC/RB Position window contents, or **Close** to close the window.
- If the Control Barcode Operation is not enabled, place the controls in the correct positions according to the "Pos.".
 - If the Control Barcode Operation is enabled with Fixed Control positions, place the controls in any Control position (listed under "Kind").
 - If the STAT table is programmed for Free positions (listed under "Kind"), place the barcoded control in any position.

- 7** Select **STAT Status > STAT Start (F1)**. Review the Error List in the STAT Start window. Verify the required samples are on the STAT table.

Figure 3.24

The screenshot shows the 'STAT Start' window. At the top, it says 'STAT Start'. Below that is a section for 'Start Sample No.' with a table and a 'Verify Next Sample No.' button. The table has columns for 'Serum', 'Urine', 'Other-1', and 'Other-2', and rows for 'Routine' and 'Repeat'. Below the table is an 'Error List' section with several lines of text, some highlighted in orange and yellow. At the bottom are 'Start' and 'Cancel' buttons.

| Start Sample No. | Serum | Urine | Other-1 | Other-2 | Verify Next Sample No. |
|------------------|-------|-------|---------|---------|------------------------|
| Routine | | | | | |
| Repeat | | | | | |

Error List

- Test has no RB Data. Please open Calibration Requisition menu and requisition the test.
- Calibration stability is expired. Please open Calibration Requisition menu and requisition the test.
- RB stability is expired. Please open Calibration Requisition and requisition the test.
- Maintenance item is expired. Please perform maintenance.
- Error sample(s) exists. Please check sample(s) in STAT Status menu.
- Maintenance item will be expired soon. Please check it.

Start Cancel

- 8** Select **Start** to initiate the automatic STAT table check (detects samples) or **Cancel** to take corrective actions.

-
- 9** If there are no errors specific to the STAT table after the STAT table check, analysis starts. If there are STAT table errors, review the errors in the STAT Start window. Select **Start** to begin analysis, or **Cancel** to perform corrective actions.
-

3.8 Start Analysis

The reaction time is approximately 8 minutes and 40 seconds for the first result to be obtained after the sample is dispensed. Every 9.0 seconds another test can be sampled.

Results can be viewed on the monitor and printed.

3.8.1 Start Rack Analysis

3.8.2 Start STAT Table Analysis

3.8.1 Start Rack Analysis

- 1 Select **Start** to display the Start window with an Error List if any errors are present. Review errors carefully and perform necessary corrective actions before starting analysis. If an error is in red, it is necessary to perform corrective actions before the analyzer can be started.

TIP Select **Edit Sample No.** to edit the starting sample number. This is only necessary in Sequential analysis.

- 2 Select **Start**. The system initializes and analysis starts if no errors are detected. The mode changes from *Standby* to *Measure 1*.

Figure 3.25

The screenshot shows a window titled "Start" with a table and an error list. The table has columns for "Type", "Serum", "Urine", "Other-1", and "Other-2". The error list contains two messages: "No Reagent volume to analyze anymore. Please check it at Reagent Management." and "Onboard Stability is expired. Please check Reagent Management and set new reagent in the refrigerator." There are "Start" and "Cancel" buttons at the bottom.

| Type | Serum | Urine | Other-1 | Other-2 |
|------------------|-------|-------|---------|---------|
| Routine | 0001 | 0001 | 0001 | 0001 |
| Emergency | 001 | 001 | 001 | 001 |
| Repeat | 0001 | 0001 | 0001 | 0001 |
| Repeat/Emergency | 001 | 001 | 001 | 001 |

Error List

- No Reagent volume to analyze anymore. Please check it at Reagent Management.
- Onboard Stability is expired. Please check Reagent Management and set new reagent in the refrigerator.

3.8.2 Start STAT Table Analysis

- 1 Select **STAT Status > STAT Start (F1)**. Review the Error List in the STAT Start window. Verify the required samples are on the STAT table.

Figure 3.26

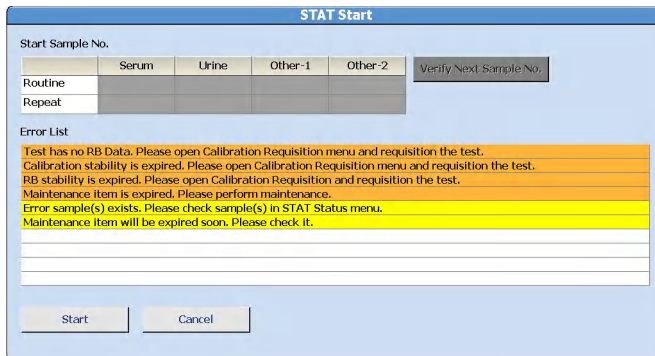

- 2 Select **Start** to initiate the automatic STAT table check (detects samples) or **Cancel** to take corrective actions.
- 3 If there are no errors specific to the STAT table after the STAT table check, analysis starts. If there are STAT table errors, review the errors in the STAT Start window. Select **Start** to begin analysis, or **Cancel** to perform corrective actions.

This chapter describes how to prepare racks and samples for analysis, requisition for samples, process emergency and priority STAT samples, perform repeat analysis, print results, and transfer data to a host computer.

4.1 Prepare Samples for Analysis

4.1.1 Rack Types

4.1.2 Place the Sample Cups/Tubes in a Rack

4.2 Placing Racks on the Rack Supply Unit

4.3 Requisition for Routine and Emergency Samples

4.3.1 Enter Manual Requisitions for Routine and Emergency Samples

4.3.2 Enter Batch Requisitions

4.3.3 Download Requisitions from a Host Computer

4.4 Processing Emergency Samples

4.5 Priority STAT Samples

4.5.1 Enter Manual Requisitions for Priority STAT Samples

4.5.2 Processing Priority STAT Samples

4.1 Prepare Samples for Analysis

TIP For detailed information and specifications on preparing samples, cups/tubes, and racks for analysis, refer to 6.1 Prepare Samples for Analysis in the *AU480 User's Guide*.



Before starting analysis, dispense a sample into sample cups/tubes and set these cups/tubes in the correct rack.



The racks come in six different colors. Each rack color has a specified purpose or application. Racks are placed on the rack supply unit. A maximum of 8 racks or 80 samples can be placed on the rack supply unit. Racks can be continuously loaded on the rack supply unit as space is available.

4.1.1 Rack Types

The system identifies the rack type from the combination of magnets set into the rack bottom.

The rack colors, applications, and magnet combinations are shown in the following table.

| Color | Rack Application | Magnet 1 2 3 |
|---|--|-----------------|
| White  | Used for analyzing routine samples and Auto Repeat run samples | ● ○ ○ |
| Blue  | Used for calculation of reagent blanks for creation of calibration curves | ● ○ ● |
| Yellow  | Used for creation of calibration curves. | ● ● ○ |

| Color | Rack Application | Magnet 1 2 3 |
|--|-------------------------------------|-----------------|
| Green  | Used for analysis of QC samples | ○ ○ ● |
| Orange  | Used for manual repeat run analysis | ● ● ● |
| Red  | Used for emergency sample analysis | ○ ● ○ |

The rack positions are numbered 1 to 10. The magnets are located on the bottom of the rack at the position number 1 end.

4.1.2 Place the Sample Cups/Tubes in a Rack

TIP For detailed information and specifications on preparing samples, cups/tubes, and racks for analysis, refer to 6.1 Prepare Samples for Analysis in the *AU480 User's Guide*.



WARNING

Beckman Coulter recommends the use of barcoded samples to guarantee positive patient identification.

In Sequential analysis, place samples in numeric Sample No. order according to the requisition without leaving any empty positions in the racks. If there are empty positions in the racks, the requisitioned sample no. and the sample no. determined during analysis will not coincide, and concordance errors can occur.

1

Place each sample in the correct rack.

Racks are color coded. Each color indicates a different type of analysis. If racks are programmed for different sample types (serum, urine, other), place the sample in the correct rack for the sample type.

For details on assigning rack ID numbers for specific sample types, refer to 4.10.2 Program the Rack Number Limit in the *AU480 User's Guide*, chapter 4.



WARNING

Insert the sample tubes/cups properly into the rack. If the tube or cup is not pushed down to the bottom of the rack, cup detection will not work properly and rack jams may occur.

2

Look at each opening in the rack and ensure the barcode is aligned in the center. 2 mm is the most each barcode should deviate from the center. If a barcode label is not aligned with the opening in the rack, lift it out and place it in correctly.

Figure 4.1

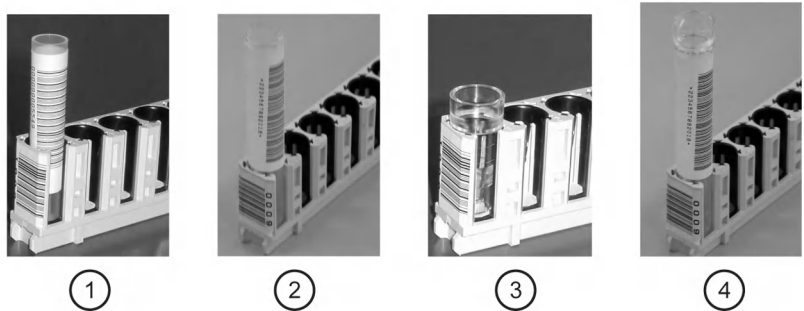

1. Small diameter tube with ID
2. Large diameter tube with ID
3. Hitachi cup
4. Large diameter tube with ID + Hitachi cup

 **WARNING**

Use only NE racks.

TIP An NE rack has a window on the side to facilitate setting different sample cup types in the rack and not compromise barcode readability.

4.2 Placing Racks on the Rack Supply Unit

A maximum of 8 racks (80 samples) can be placed on the rack supply unit.



Never look directly into the barcode readers. The LED can cause serious eye damage.

To place racks on the rack supply unit:

TIP If Auto Repeat is in use, the rack supply unit automatically moves approximately every 30 seconds to move racks with samples requiring repeat analysis. Do not place racks on the rack supply unit if the rack supply unit is moving.

1 Open the sample protection cover.

2 Place the racks on the rack supply unit.

Figure 4.2

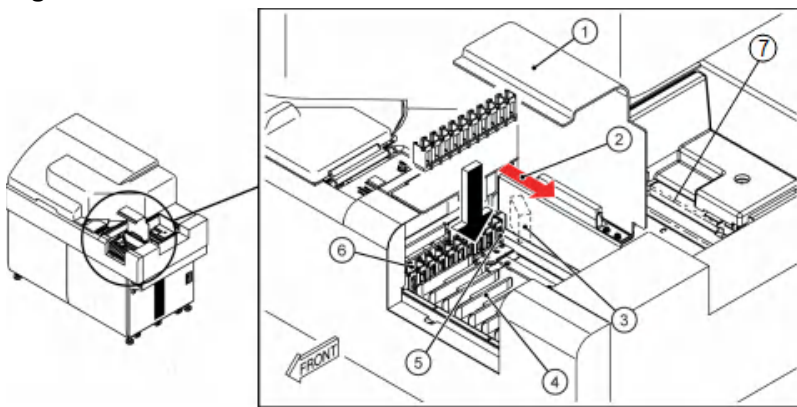

- | | |
|--|--|
| 1. Sample protection cover | 4. Rack supply unit |
| 2. Barcode reader laser radiation (Sample ID) | 5. Surface where rack ID is applied |
| 3. Window for reading rack ID | 6. Rack |
| | 7. Rack collection unit |

Figure 4.3

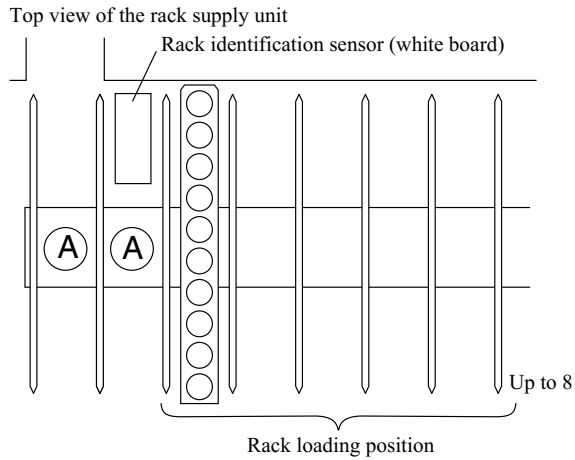

Place the first rack to the right of position A. The rack supply unit does not operate properly when it is placed on position A.

- 3** For calibration and QC, place the blue rack followed by the yellow rack(s), followed by the green rack(s). Place the white racks for routine patient samples.

Figure 4.4

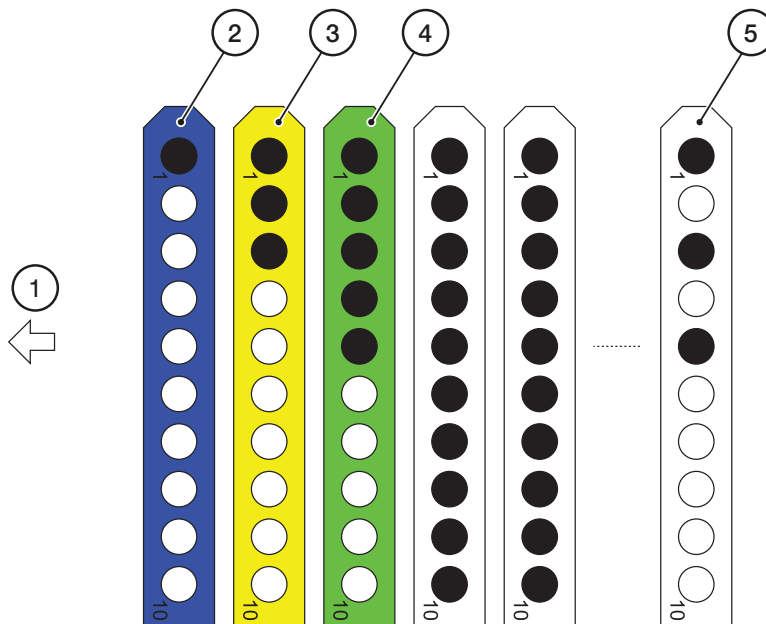

1. Direction that the racks move on the rack supply unit
2. Place a cup filled with DI water or Diluent in position 1 or 2
3. Place in any order
4. Place in any order
5. Place in any order

TIP DI water or diluent can be programmed to position 1 or 2 in the blue reagent blank rack in **Parameters > Calibration Parameters > Calibrators** in the RB Sample Information fields for each sample type.

CAUTION

- When several yellow racks are required for creation of calibration curves, set the yellow racks one after the other.
- When several green racks are required for QC analysis, set the green racks one after the other.

4 Close the sample protection cover.

4.3 Requisition for Routine and Emergency Samples

Sample information and the tests requested to run on a sample (requisitions) must be entered for each sample to be analyzed.

To run an emergency sample, requisition the sample as Emergency, and place the sample in a red rack. Place the red rack in front of routine white racks on the rack supply unit.

The system uses these requisitions to process each sample:

[4.3.1 Enter Manual Requisitions for Routine and Emergency Samples](#)

[4.3.2 Enter Batch Requisitions](#)

[4.3.3 Download Requisitions from a Host Computer](#)

4.3.1 Enter Manual Requisitions for Routine and Emergency Samples

TIP The following operations are not necessary when LIS programming is available.

- 1 Select **Home > Rack Requisition Sample > Sample > Test Requisition**. The Group of tests display from the Group selected in **Start Condition**.

Figure 4.5

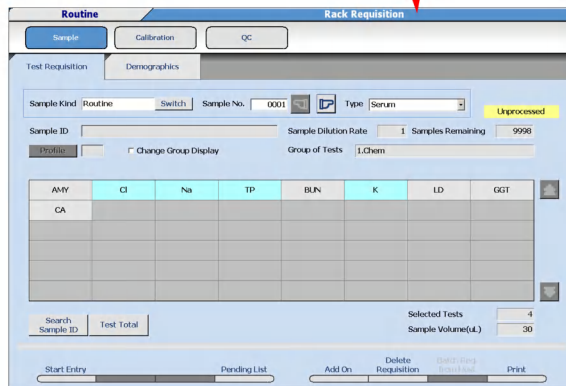
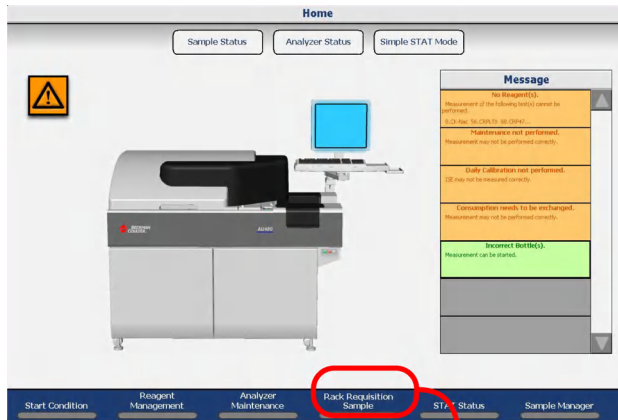

-
- 2** Select **Switch** for Sample Kind to select **Routine** or **Emergency** samples.
- Routine: Routine analysis in a white rack
Emergency: Analysis in a red rack
-
- 3** Select the sample type from the "Type" drop-down list.
-
- 4** Select **Start Entry (F1)**. The window changes to the edit mode.
- TIP** When a test not in the present group is to be selected, select the "Change Group Display" check box. The tests for all groups are displayed on the list.
-
- 5** For Sample ID, enter the sample barcode number.
-
- 6** If a manual dilution was made on the sample, select **Sample Dilution (F7)** and enter the sample dilution rate.
-
- 7** Select the test(s) to run on the sample. A test highlights in blue when it is requisitioned. Select the test again to cancel the requisition. Tests highlighted in gray are not operational for the sample type selected.
-
- 8** When selecting a profile, perform one of the following operations:
- Select **Profile** to open the profile window and select a profile (or multiple profiles).
 - Use the keyboard to enter a profile number into Profile and press Enter.
- TIP** It is necessary to program profiles in **Menu List > Parameters > Common Test Parameters > Profile > Sample** before a profile is available to requisition. A maximum of 99 profiles can be created for each sample type.
- Each time a test is selected, the Selected Tests and Sample Volume fields are updated.

9 Select the **Demographics** tab to enter any required patient demographic information.

10 Confirm the entered information and select **Entry (F1)**. The entered information is programmed.

11 Repeat steps 5 through 10 to requisition additional samples in the same Sample Kind and Type. To change the Sample Kind or Type, select **Exit (F2)** and repeat steps 2 through 10.

12 Select **Exit (F2)**.

TIP Pending List (F4)

View a list of samples that have been requisitioned, but not yet processed on the analyzer. Select a Sample No. or Sample ID number, then select **Go** to view the specific sample requisition.

Add-On (F5)

“Add-On” a test to a previously processed sample in the white rack. Run the sample again in the white rack to perform the add-on test(s).

Delete Requisition (F6)

This function is used to delete registered requisition information before the start of analysis. Select each “Sample Kind”, then specify the Sample No. or Sample ID to delete.



**“Sample Volume (µL)” does not include the dead volume.
Approximate values are shown.**

4.3.2 Enter Batch Requisitions

To perform the same tests on a number of samples, enter the requisitions in a single batch.

Tests requisitioned for one sample are requisitioned for all samples in the batch. Patient information entered for a single sample in the **Demographics** tab is requisitioned for all samples in the batch. If barcode analysis is in use, the Sample ID entered for the first sample automatically increments by one digit for subsequent samples.

To enter batch requisition:

- 1 Select **Home > Rack Requisition Sample > Sample**. The Group of tests display from the Group selected in **Start Condition**.

Figure 4.6

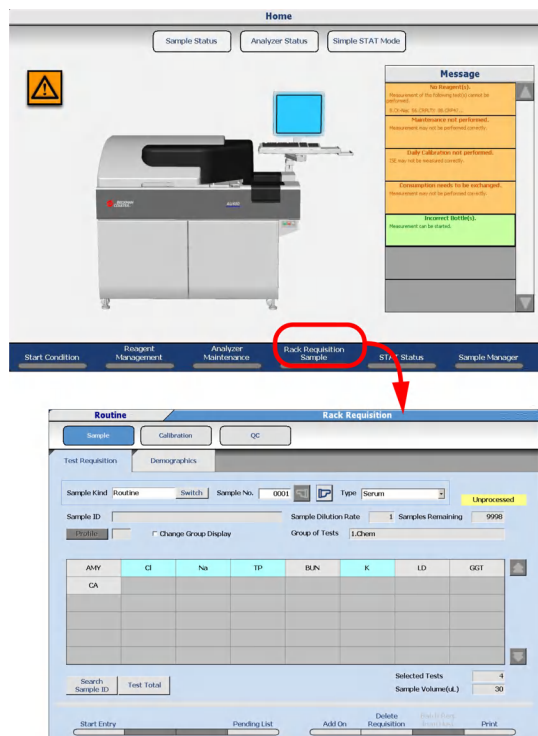

2 Select **Start Entry (F1)**.

3 Select the test(s) or profile for batch requisition for one sample. For details on manually requisitioning tests, refer to [4.3.1 Enter Manual Requisitions for Routine and Emergency Samples](#) in this chapter.

4 Select **Batch Entry (F3)**. The Batch Entry window opens.

Figure 4.7

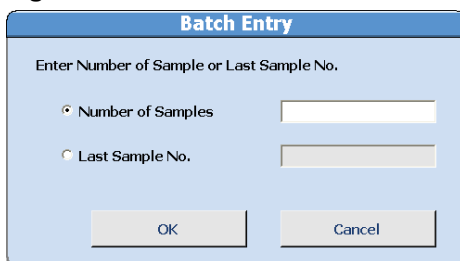

5 Select **Number of Samples** to enter the actual number of samples required in the batch, or select **Last Sample No.** to enter the last sample number in the batch.

6 Select **OK**.

7 Select **Exit (F2)**.

4.3.3 Download Requisitions from a Host Computer

Requisitions can be downloaded from a clinical laboratory host computer system. Downloading can be:

- Realtime: the system downloads and executes requisitions automatically.
- Batch: the system waits for a user to instruct it to download and execute requisitions.

For information on how to configure these modes, refer to 4.12 Program Online Parameters in the *AU480 User's Guide*, chapter 4.

To download requisitions from a host computer:

- 1 Select **Home > Rack Requisition Sample > Sample**.

Figure 4.8

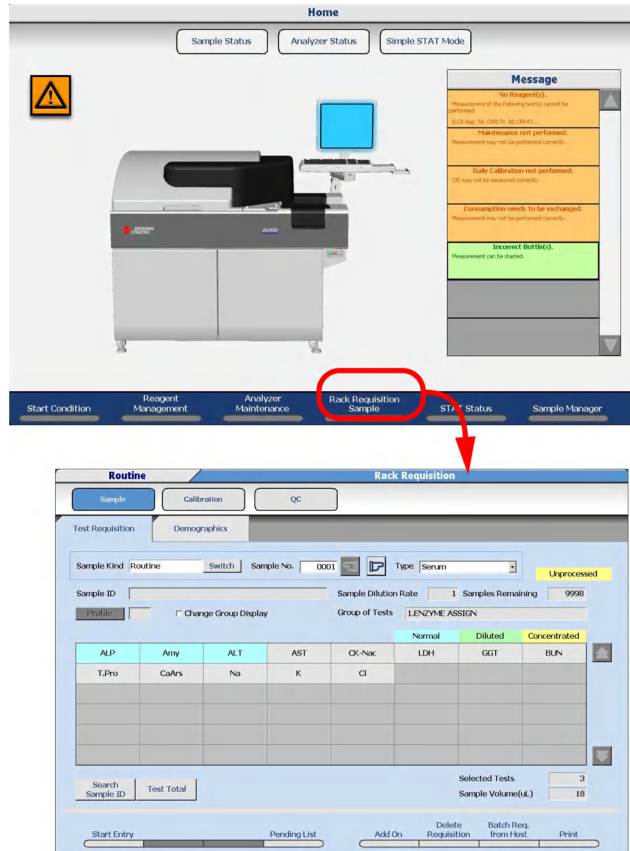

- 2 Select **Batch Req. from Host (F7)**.

-
- 3 Select the sample kind and type from the "Sample Kind" drop-down list.

Figure 4.9

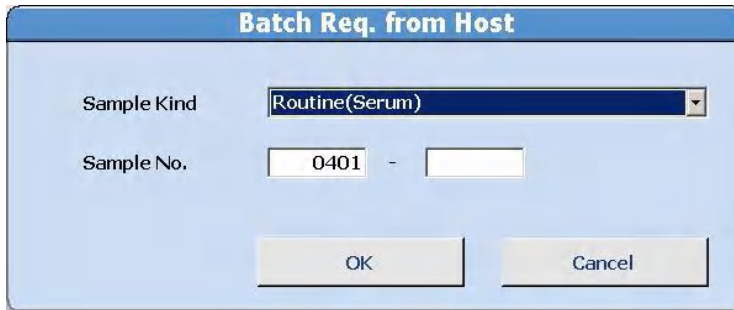

The screenshot shows a dialog box titled "Batch Req. from Host". It has a light blue background and a blue title bar. Inside the dialog, there are two main sections. The first section is labeled "Sample Kind" and features a dropdown menu with "Routine(Serum)" selected. The second section is labeled "Sample No." and contains two text input fields separated by a hyphen. The first input field contains the number "0401", and the second is empty. At the bottom of the dialog, there are two buttons: "OK" on the left and "Cancel" on the right.

-
- 4 For Sample No., enter the starting and ending sample numbers to download from the host computer.
 - 5 Select **OK**. A message displays while the requisitions are downloading. When the download is complete, the message window closes.
-

4.4 Processing Emergency Samples

Red racks are used for analysis of emergency samples. Emergency samples can be processed with priority over routine samples by placing the red racks in front of the white racks on the rack supply unit. Emergency samples are identified by an “E” sample number prefix in the requisition and sample results.

The fastest way to process a sample is from the Priority STAT Table. Refer to [4.5.2 Processing Priority STAT Samples](#).

4.5 Priority STAT Samples

The STAT table is used for analysis of priority STAT samples. Priority STAT samples run on the STAT table interrupt the routine and emergency samples being processed from the rack transport belt. A priority STAT is the fastest way to process a sample. Priority STAT samples are identified by a "P" sample number prefix in the requisition and sample results.

4.5.1 Enter Manual Requisitions for Priority STAT Samples

4.5.2 Processing Priority STAT Samples

4.5.1 Enter Manual Requisitions for Priority STAT Samples

TIP If communication with the LIS is not functioning, requisitions can be made for priority STAT samples in **STAT Status**.

- 1 Select **Home > STAT Status > Sample**.

Figure 4.10

The screenshot shows the 'STAT Requisition' window with the 'Sample' tab selected. The 'Sample Kind' is set to 'STAT' and 'Sample No.' is '001'. The 'Type' is 'Serum'. The 'Sample ID' is '20872'. The 'Group of Tests' is '1.Chemistry'. A table of test options is displayed with columns for 'Normal', 'Diluted', and 'Concentrated'. The 'ALT' test is selected under the 'Normal' column. The 'AST' test is selected under the 'Diluted' column. The 'CO2' test is selected under the 'Concentrated' column. The 'TRIG' test is also visible in the first row. The 'Selected Tests' count is 3 and the 'Sample Volume(L)' is 21.

| | Normal | Diluted | Concentrated |
|------|----------|----------|--------------|
| ALT | Selected | | |
| AST | | Selected | |
| CO2 | | | Selected |
| CHOL | | | |
| GLU | | | |
| CRE | | | |
| GGT | | | |
| BUN | | | |
| TRIG | | | |

- 2 Select **Start Entry (F1)**.
- 3 Select the sample type from the "Type" drop-down list.
- 4 Enter the sample ID (barcode number) at Sample ID.

-
- 5 Select the test(s) or profiles to be performed.

 - 6 Select **Entry (F1)**.

 - 7 Repeat steps 4 through 6 to requisition another sample with the same sample type.

 - 8 Select **Exit (F2)** to end the requisition process.

 - 9 To requisition for a sample with a different sample type, repeat steps 2 through 8.
-

4.5.2 Processing Priority STAT Samples

Processing Priority STAT Samples in Barcode Analysis

TIP STAT table positions 1 to 22 are programmed by Beckman Coulter Technical Services for priority STAT samples as <First Run> (fixed) or <Free Position> (open). Refer to 4.10.3 Program STAT Table Parameters for information on programming the STAT table positions in the *AU480 User's Guide*, chapter 4. In **STAT Status**, Kind displays as Routine if the position is programmed as <First Run>, and Free if the position is programmed as <Free Position>.

1 Select **Home** > **STAT Status**.

Figure 4.11

The screenshot shows the 'STAT Status' screen with a table of cup information. The table has columns for Pos, Kind, Type, Cup, Status, Sample No., Cup Information, ID, and Comment. The 'Cup Information' column is highlighted in yellow for row 22, which shows 'Checkback Level 1' and '63424'. Below the table is a section for 'RB Cup Information' with columns for Pos, Cup, Status, Cup Information, and Comment. At the bottom, there are buttons for 'STAT Start', 'STAT Pause', 'STAT Check', 'CAL/QC Position', 'Previous Cup Set', and 'Sample ID Edit'.

2 Check the Pos. and Kind for available Routine and Free positions on the STAT table.

TIP

- When the amber STAT TABLE LED is blinking, select **STAT Pause (F2)** to move the STAT table to *Pause*.
- To continue analysis, verify the STAT table cover is closed and select **STAT Start (F1)**.

 **CAUTION**

- The analyzer shifts to *Pause* if the STAT table is in *Pause* for an extended period of time. The time for the analyzer to move to *Pause* depends on why the STAT TABLE LED continuously blinks slowly:
 - Sample contamination parameters
 - Reagent blank or calibrator programmed on the STAT table
 - Cyclic QC programmed on the STAT table
- Do not remove pending reagent blank, calibrator, QC, or samples from the STAT table. After STAT Start (F1), an alarm is generated if pending samples are removed from the STAT table.

-
- 3** Lift the small cover over the STAT table and load samples. Press the TABLE ROTATION/DIAG button as required to rotate the table. Close the small cover.

 - 4** Select **STAT Start (F1)**.

 - 5** Review the Error List in the STAT Start window.

 - 6** Select **Start** to initiate the automatic STAT table check, or **Cancel** to take corrective actions.

 - 7** If there are no errors specific to the STAT table after the STAT table check, analysis starts. If there are STAT table errors, review the errors in the STAT Start window. Select **Start** to begin analysis, or **Cancel** to perform corrective actions.

 - 8** Verify the Cup(s) displays as Present, the Status, and Comment.

TIP The amber STAT TABLE LED blinks until sample aspiration is complete. The small STAT table cover can be opened when the amber STAT TABLE LED is not blinking to remove existing samples and load new samples. If the small STAT table cover is opened when the amber STAT TABLE LED is blinking, a "STAT Small Cover Open" alarm is generated.

Processing Priority STAT Samples in Sequential Analysis

- 1 Select **Home** > **STAT Status**.

Figure 4.12

| Ptn | Stat | Type | Cup | Status | Sample No. | Cup Information | ID | Comment |
|-----|--------|-------|---------|--------|------------|------------------------|----|---------|
| 1 | Normal | Serum | Present | | 001 | | | |
| 2 | Normal | Serum | None | | | | | |
| 3 | Normal | Serum | None | | | | | |
| 4 | Normal | Serum | None | | | | | |
| 5 | Normal | Serum | None | | | | | |
| 6 | Normal | Serum | None | | | | | |
| 7 | Normal | Serum | None | | | | | |
| 8 | Normal | Serum | None | | | | | |
| 9 | Normal | Serum | None | | | | | |
| 10 | Normal | Serum | None | | | | | |
| 11 | Normal | Serum | None | | | | | |
| 12 | Normal | Serum | None | | | | | |
| 13 | Normal | Serum | None | | | | | |
| 14 | Normal | Serum | None | | | | | |
| 15 | Normal | Serum | None | | | | | |
| 16 | Normal | Serum | None | | | | | |
| 17 | Normal | Serum | None | | | | | |
| 18 | Normal | Serum | None | | | | | |
| 19 | QC | Serum | None | | | 001: SYSTEM CALIBRATOR | | No Cup |
| 20 | QC | Serum | None | | | 002: QC# 1 | | No Cup |
| 21 | QC | Serum | None | | | 003: control 1 | | No Cup |
| 22 | QC | Serum | None | | | 004: control 2 | | No Cup |

RB Cup Information

| Ptn | Cup | Status | Cup Information | Comment |
|-----|------|--------|-----------------|---------|
| RB1 | None | | | |
| RB2 | None | | | |

STAT Start STAT Pause STAT Check Sample Assignment CAL/QC Position Previous Cup Set

TIP

- When the amber STAT TABLE LED is blinking slowly, select **STAT Pause (F2)** to move the STAT table to *Pause*.
- To continue analysis, verify the STAT table cover is closed and select **STAT Start (F1)**.



CAUTION

- The analyzer shifts to *Pause* if the STAT table is in *Pause* for an extended period of time. The time for the analyzer to move to *Pause* depends on why the STAT TABLE LED continuously blinks slowly:
 - Sample contamination parameters
 - Reagent blank or calibrator programmed on the STAT table
 - Cyclic QC programmed on the STAT table
- Do not remove pending reagent blank, calibrator, QC, or samples from the STAT table. After STAT Start (F1), an alarm is generated if pending samples are removed from the STAT table.

2 Lift the small cover over the STAT table and load samples. Verify the sample positions: each outer position of the STAT table (1-22) is programmed for Kind (Normal, Repeat, Calibrator, or QC) and Type (Serum, Urine, Other-1, or Other-2). Press the TABLE ROTATION/DIAG button as required to rotate the table. Close the small cover.

3 Select **STAT Check (F3)**. The table rotates and the tube(s) are detected. Cup displays “Present” in yellow for each sample.

TIP In Sequential Analysis on the STAT table, it is necessary to requisition for STAT samples from **STAT Status > Sample**. Refer to [4.5.1 Enter Manual Requisitions for Priority STAT Samples](#).

4 A green highlight appears over Sample Assignment based on the Kind and Type. Select **Sample Assignment (F4)**:

- Verify the Kind (Normal or Repeat)
- Verify the Type (Serum, Urine, Other-1, Other-2)
- Select Unprocessed (unprocessed samples) or All Samples (processed samples are inaccessible) at the "Option" drop-down list.
- Assign a position for each Sample No. on the STAT table from the "Pos." drop-down list.

Figure 4.13

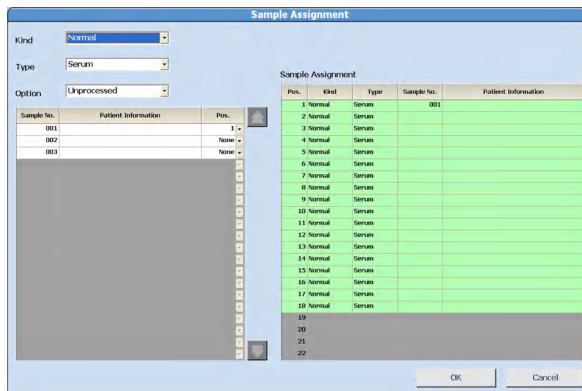

5 Select **OK**.

6 Select **STAT Start (F1)**. The STAT Start window opens.

7 Review the Error List in the STAT Start window. Select **Cancel** to perform corrective actions.

8 Select **Start**.

Analysis is started.

TIP The amber STAT TABLE LED blinks quickly until sample aspiration is complete. The small STAT table cover can be opened when the amber STAT TABLE LED is not blinking to remove existing samples and load new samples. If the small STAT table cover is opened when the amber STAT TABLE LED is quickly blinking, a "STAT Small Cover Open" alarm is generated.

This chapter describes how to review results using the software or printed reports, and check the results for flags and alarms.

5.1 Monitor Results

5.2 Identifying Sample Types by Sample Data Prefix

5.3 Sample Status Menu

5.4 Reports

5.5 Check for Error Flags and Alarms

5.5.1 Check for Error Flags

5.5.2 Check for Alarms

5.1 Monitor Results

It is important to verify daily reagent blank, calibration, and control (QC) results are acceptable before reporting sample results. All results including reagent blank, calibration, QC, and samples should be reviewed for error flags and appropriate corrective actions taken before reporting the results. In addition, the **Alarm List** should be reviewed and appropriate corrective actions taken for any alarms generated.

Refer to 7.3 Check Results in the *AU480 User's Guide*, chapter 7, for more information on monitoring reagent blank, calibration, QC, and sample results.

For more information on troubleshooting and corrective actions, refer to 11.3 Troubleshooting the System - Reagents, Calibrators, Quality Control and Samples in the *AU480 User's Guide*, chapter 11.

5.2 Identifying Sample Types by Sample Data Prefix

| Type | | Normal Run | Repeat Run |
|------------------|---------|------------|------------|
| Routine | Serum | (None) | H |
| | Urine | U | HU |
| | Other-1 | X | HX |
| | Other-2 | Y | HY |
| Emergency sample | Serum | E | HE |
| | Urine | UE | HUE |
| | Other-1 | XE | HXE |
| | Other-2 | YE | HYE |
| STAT sample | Serum | P | HP |
| | Urine | UP | HUP |
| | Other-1 | XP | HXP |
| | Other-2 | YP | HYP |
| QC | Q | | |
| CAL | A | | |
| RB | R | | |

5.3 Sample Status Menu

Select **Sample Status** to view sample information, time to completion, and results.

- 1 Select **Home > Sample Status**.

Figure 5.1

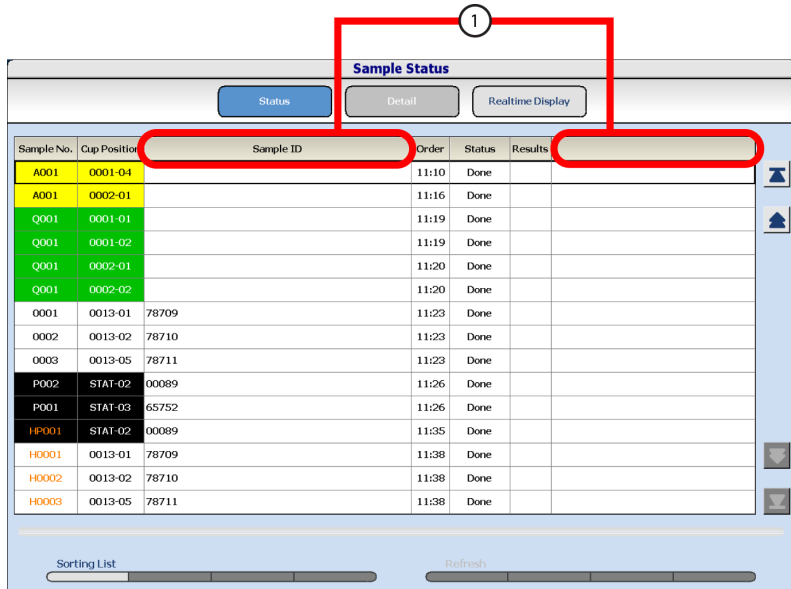

The screenshot shows the 'Sample Status' interface. At the top, there are three buttons: 'Status' (highlighted with a red box and a circled '1'), 'Detail', and 'Realtime Display'. Below the buttons is a table with columns: Sample No., Cup Position, Sample ID, Order, Status, and Results. The table contains 18 rows of data, with rows grouped by color (yellow, green, white, black, orange). The 'Sample ID' column is highlighted with a red box. The 'Status' column is also highlighted with a red box. The 'Results' column is highlighted with a red box. At the bottom of the interface, there are 'Sorting List' and 'Refresh' buttons.

| Sample No. | Cup Position | Sample ID | Order | Status | Results |
|------------|--------------|-----------|-------|--------|---------|
| A001 | 0001-04 | | 11:10 | Done | |
| A001 | 0002-01 | | 11:16 | Done | |
| Q001 | 0001-01 | | 11:19 | Done | |
| Q001 | 0001-02 | | 11:19 | Done | |
| Q001 | 0002-01 | | 11:20 | Done | |
| Q001 | 0002-02 | | 11:20 | Done | |
| 0001 | 0013-01 | 78709 | 11:23 | Done | |
| 0002 | 0013-02 | 78710 | 11:23 | Done | |
| 0003 | 0013-05 | 78711 | 11:23 | Done | |
| P002 | STAT-02 | 00089 | 11:26 | Done | |
| P001 | STAT-03 | 65752 | 11:26 | Done | |
| HP001 | STAT-02 | 00089 | 11:35 | Done | |
| H0001 | 0013-01 | 78709 | 11:38 | Done | |
| H0002 | 0013-02 | 78710 | 11:38 | Done | |
| H0003 | 0013-05 | 78711 | 11:38 | Done | |

1. User-defined patient demographic can be programmed

The **Status** menu displays:

- Sample No.: The sample number displays highlighted in the color of the rack.
- Cup Position: The rack ID and cup position display highlighted in the color of the rack.
- Sample ID: The sample ID (barcode) displays.

- Order: The time the cup in the rack went past the cup detector on the rack transport belt.
- Status: Displays “In Process” while sample analysis is in process, or “Done” when sample analysis is complete.
- Results: Displays the time to completion when the sample is in process, or “Error” if the sample is complete, and an error flag is present.

2 Highlight a sample, then select **Detail** to view detailed sample information. The test name displays with the result when the result is complete.

Figure 5.2

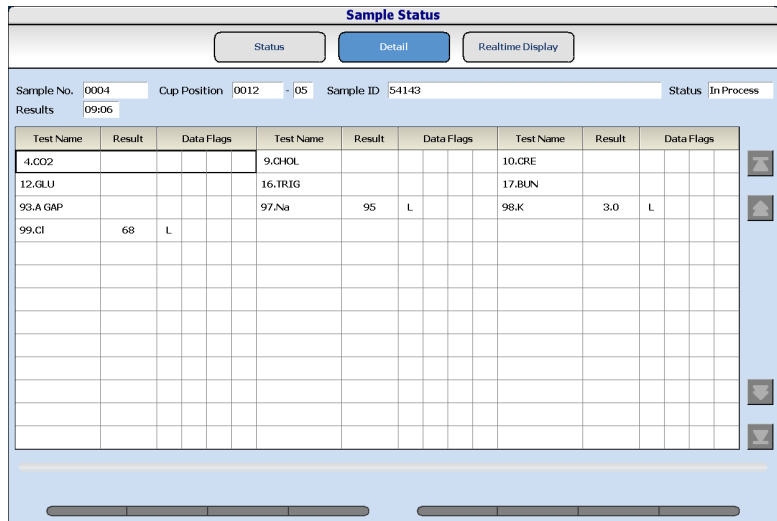

3 Select **Realtime Display** to view the sample results.

Tests without error flags display in black, and tests with error flags display in red.

The **All** tab displays the samples in completion order when all tests requisitioned on the sample are complete.

The **Quick** tab is for results from the STAT table only, and displays the ISE tests, and tests with only an R1 reagent with read points before P10 when these tests are complete.

The **ISE** tab displays the ISE tests when the ISE tests are complete.

Figure 5.3

| Sample Status | | | | | | | | | |
|---------------|---------|--------|-----------|--------|-----|------------------|-----|--|--|
| | | Status | | Detail | | Realtime Display | | | |
| All | | Quick | | ISE | | | | | |
| MG | 1.7 | TRIG | 109 | BUN | 14 | | | | |
| Sample No. | Q003-2 | Serum | Sample ID | | | | | | |
| Na | 148 | K | 6.0 | Cl | 117 | CO2 | 25 | | |
| ALT | bh | AST | 180 | DBIL | 1.1 | TBIL | 4.5 | | |
| CHOL | bh | CRE | 5.5 | GGT | 85 | GLU | 260 | | |
| MG | 4.8 | TRIG | 266 | BUN | 52 | | | | |
| Sample No. | Q003-11 | Urine | Sample ID | | | | | | |
| Na | 89 | K | 33.8 | Cl | 62 | CRE | 77 | | |
| GLU | 26 | BUN | 427 | | | | | | |
| Sample No. | Q003-12 | Urine | Sample ID | | | | | | |
| Na | 191 | K | 88.9 | Cl | 199 | CRE | 163 | | |
| GLU | 276 | BUN | 820 | | | | | | |
| Sample No. | 0006 | Serum | Sample ID | 55324 | | | | | |
| Na | 131 | K | 3.8 | Cl | 95 | CO2 | 11 | | |
| ALT | bh | AST | 69 | DBIL | 0.5 | TBIL | 1.8 | | |
| CHOL | bh | CRE | 2.1 | GGT | 30 | GLU | 108 | | |
| MG | 2.2 | TRIG | 140 | BUN | 23 | A GAP | 29 | | |
| TBIL | 1 | | | | | | | | |
| Sample No. | 0005 | Serum | Sample ID | 55323 | | | | | |
| Na | 130 | K | 3.6 | Cl | 93 | CO2 | 10 | | |
| ALT | bh | AST | 60 | DBIL | 0.5 | TBIL | 1.5 | | |
| CHOL | bh | CRE | 1.8 | GGT | 26 | GLU | 96 | | |
| MG | 1.9 | TRIG | 137 | BUN | 21 | A GAP | 31 | | |
| TBIL | 1 | | | | | | | | |
| Sample No. | 0004 | Serum | Sample ID | 55322 | | | | | |
| Na | 128 | K | 3.3 | Cl | 91 | CO2 | 9 | | |
| ALT | bh | AST | 47 | DBIL | 0.4 | TBIL | 1.2 | | |
| CHOL | bh | CRE | 1.4 | GGT | 20 | GLU | 79 | | |
| MG | 1.7 | TRIG | 126 | BUN | 17 | A GAP | 31 | | |
| TBIL | 1 | | | | | | | | |

5.4 Reports

Data prints in a user-defined report format. Multiple reports have been pre-programmed on the system. The pre-programmed reports can be modified to accommodate specific laboratory requirements. Refer to 4.14 Print Formats in the *AU480 User's Guide*, chapter 4, or contact Beckman Coulter Technical Services for more information.

Results can print realtime for reagent blank, calibration, QC, and/or samples. Refer to 4.14.1 Format Realtime Reports and Lists in the *AU480 User's Guide*, chapter 4.

Results can be printed from **Home > Sample Manager** at any time. Refer to 6.7 Print Results in the *AU480 User's Guide*, chapter 6.

5.5 Check for Error Flags and Alarms

5.5.1 Check for Error Flags

If a problem occurs during analysis, the system appends a flag to the analysis results. It is important that the operator reviews each flag as it is generated and identifies the root cause. No result should be reported with an unresolved and unexpected flag.

If a test generates an error flag, the test name and error flag appear in red on **Sample Status**.

Check all generated results carefully for error flags and take the appropriate action.

For a list of error flags and the flag definition, refer to [8.3 Review Error Flags](#) in chapter 8.

For details on error flags, refer to CHAPTER 9, *Error Flags* in the *AU480 User's Guide*.

5.5.2 Check for Alarms

Check if any alarms occur during analysis:

Select **Alarm List** ( on the lower, right corner of the screen).

Figure 5.4



| No. | Date | Level | Alarm No. | Alarm |
|-----|---------------------|-------|-----------|--|
| 53 | 2009/12/16 11:24:11 | 3 | 5011 | SYSTEMEND |
| 54 | 2009/12/16 11:18:18 | 2 | 6025 | NO CALIBRATION DATA (s1.7o , Urine , 1, OUTER, 2) |
| 55 | 2009/12/16 11:18:18 | 2 | 6025 | NO CALIBRATION DATA (UN120I, Serum , 1, INNER, 2) |
| 56 | 2009/12/16 11:18:18 | 2 | 6025 | NO CALIBRATION DATA (s1.7i , Urine , 1, INNER, 2) |
| 57 | 2009/12/16 11:17:16 | 2 | 6025 | NO CALIBRATION DATA (s1.7o , Urine , 1, OUTER, 2) |
| 58 | 2009/12/16 11:17:16 | 2 | 6025 | NO CALIBRATION DATA (UN120I, Serum , 1, INNER, 2) |
| 59 | 2009/12/16 11:17:16 | 2 | 6025 | NO CALIBRATION DATA (s1.7i , Urine , 1, INNER, 2) |
| 60 | 2009/12/16 11:06:39 | 3 | 5031 | INDEX UPDATED (2009/12/16 11:06) |
| 61 | 2009/12/16 11:06:37 | 3 | 5004 | STANDBY |
| 62 | 2009/12/16 11:06:33 | 3 | 5003 | WARMUP |
| 63 | 2009/12/16 11:06:23 | 3 | 5090 | LOGIN (AUS800 , 1) |
| 64 | 2009/12/16 11:06:18 | 1 | 9001 | PROGRAM INF ([AriComm/GetSystemConstruct,4], MAC address : Loop Back Address.(Sampler) |
| 65 | 2009/12/16 11:06:17 | 3 | 5002 | INITIALIZE |
| 66 | 2009/12/16 11:06:17 | 3 | 5051 | POWER ON |
| 67 | 2009/12/16 11:04:47 | 3 | 5011 | SYSTEMEND |
| 68 | 2009/12/16 10:39:52 | 3 | 5031 | INDEX UPDATED (2009/12/16 10:33) |
| 69 | 2009/12/16 10:33:55 | 3 | 5004 | STANDBY |
| 70 | 2009/12/16 10:33:52 | 3 | 5003 | WARMUP |
| 71 | 2009/12/16 10:33:42 | 3 | 5090 | LOGIN (AUS800 , 1) |
| 72 | 2009/12/16 10:33:41 | 1 | 9001 | PROGRAM INF ([AriComm/GetSystemConstruct,4], MAC address : Loop Back Address.(Sampler) |

“Level” shows the alarm level by numbers and colors.

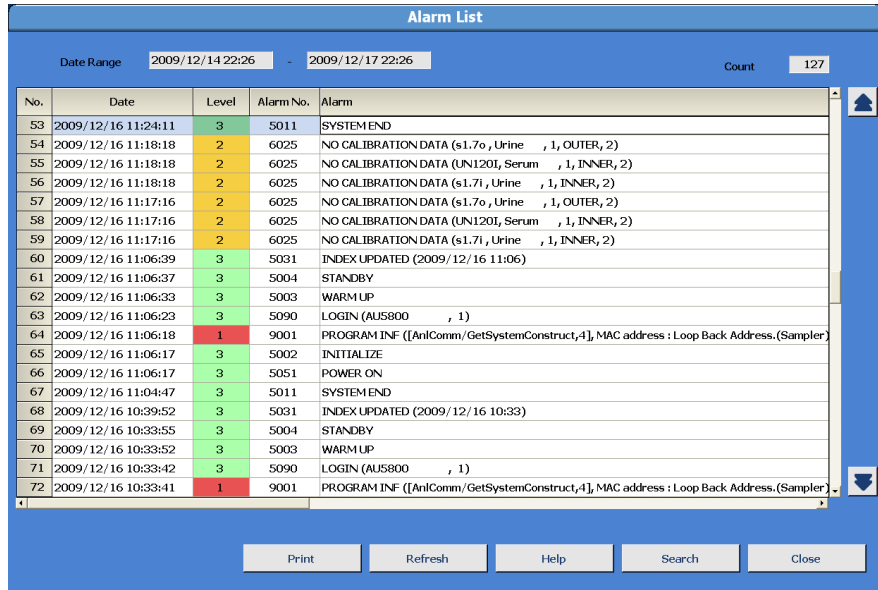
| Level | Background Color | Extent |
|---------|------------------|--|
| Level 1 | Red | A fatal system abnormality exists. |
| Level 2 | Yellow | An abnormality influencing the data exists. |
| Level 3 | Green | There is no system abnormality. The operation log is displayed. |

The “Count” at the right top of the window indicates the number of alarms within “Date Range.” Nine hundred and ninety-nine (999) cases can be stored and displayed using the scroll bar.

From this window, the following options can be performed:

- **Print:** Prints a list of all alarms.
- **Refresh:** Returns the display to the most recent alarms.
- **Help:** Displays a description of the alarm and corrective actions.
- **Search:** Searches for alarms by date, alarm number, and/or alarm level.
- **Close:** Closes the Help window.

This chapter describes how to program a new test, review and edit results, manage data, manage reagents, and other as needed tasks.

6.1 Program a New Test

6.2 Create a Profile

6.2.1 Create a Sample Profile

6.2.2 Create a Reagent Blank or Calibration Profile

6.2.3 Create a QC Profile

6.3 Program Calibrator Concentrations

6.4 Program Preset QC Mean and Range

6.5 Program the Automatic Startup Function

6.6 Program a User Menu

6.7 Print Results

6.7.1 Print Sample Data Reports

6.7.2 Print Reagent Blank, Calibration, and QC Results

6.8 Transfer Data to Host Computer

Before transfer, confirm that the system is online and connected to a clinical laboratory host computer system.

6.8.2 Reagent Blank, Calibration, and QC Data

6.9 Fix (Assign) a Reagent Position

6.10 Edit a Reagent ID

6.11 Reagent Inventory

6.11.1 Auto Calculation of Reagent Inventory

6.11.2 Manual Calculation of Reagent Inventory

6.12 Reagent Consumption

6.12.1 Check Reagent Consumption by Samples Measured and Reagent Dispense

6.12.2 Save Reagent Consumption Data

6.13 Edit Quality Control Data

6.14 Save Data to External Media

6.15 Save or Load Parameters

6.15.1 Save or Load Parameter Files

6.16 Disable a Test

6.1 Program a New Test

Program a new test using the chemistry setting sheet. Refer to the *AU480 User's Guide*, CHAPTER 4, *Parameters* for detailed Parameter menu descriptions.

1 Select **Menu List > Parameters > Common Test Parameters > Test Name**.

- Select **Edit (F1)**.
- Test Name: Enter a maximum of 6 characters.



CAUTION

Changing the test name affects all results associated with that test number. Any previously reported results (with the old test name) are assigned the new test name. Extreme caution must be applied when making any changes to the test name.

DO NOT CHANGE THE TEST NAME WITHOUT NOTING THE TIME AND DATE THAT THE CHANGE OCCURRED AND THEN ENSURING ANY RESULTS PRINTED OUT PRIOR TO THIS TIME AND DATE ARE REVIEWED AND CORRECTLY IDENTIFIED.

Tests are processed on a sample in the test number order (1 to 120) displayed, with some exceptions. For information on contamination parameters, refer to the *AU480 User's Guide*, chapter 4.

- Long Name: (Optional) Enter a maximum of 20 characters.
- Reagent ID: Enter the first 3 digits of the reagent ID, or refer to the chemistry setting sheet for the reagent ID 3-digit code.
- Alarm Shots: Enter the remaining test number to generate a Reagent Short alarm. The default is 32.
- Multi Reagent Switch: Select **Yes**. This allows the analyzer to switch to a new set of R1/R2 when either the R1 or R2 of a set becomes empty.
- Verify the information and select **Confirm (F1)**.

2 Select **Group of Tests**.

- Select Group 1, 2, or 3 from the "Group" drop-down list.
 - Select **Edit (F1)**.
 - Select **Test Setting (F5)**.
 - Select the test to add to the Group. The test name highlights in blue. Select **Close**.
 - To change the print order: Select a test to enable **Forward (F2)** and **Backward (F3)**. Move the test in the Group as needed to change the print order.
 - Verify the information and select **Confirm (F1)**.
-

3 Select **Profile**.

- Select **Edit (F1)**.
- Select **Sample, RB/Calibration**, and **QC** as needed to add the test to any required profile. Verify the Sample Type for each profile.

TIP In the **Sample** tab, a user-defined default profile (number 0) can be programmed for each sample type. The sample default profile is performed when there is no requisition available for a sample, for example with a sample ID read error. In the **QC** tab, default QC profiles (numbers 87-98) can be programmed based on sample type and Group. The QC default profile is the automatic QC requisition made after a reagent volume check, and after processing QC samples.

- Select a profile at the "Profile Name" drop-down list.
- Select the test. The selected tests highlight in blue.
- Verify the information and select **Confirm (F1)**.

4 Select **Menu List > Parameters > Specific Test Parameters > General.**

- Select **Edit (F1).**
- Select the test from the "Test Name" drop-down list.
- Select the sample type from the "Type" drop-down list. Verify **Yes** is selected for the sample type for the new test from the "Operation" drop-down list.
- Enter the specific test parameters from the chemistry setting sheet.
- Verify the information and select **Confirm (F1).**

TIP Display the parameters for a maximum of 6 tests at a time for verification. Select **List Display (F7).** The first 6 tests display. Use the arrows to page to the new test.

5 Select **Range.**

- Verify the test name at the "Test Name" drop-down list.
- Select the sample type from the "Type" drop-down list.
- Select **Edit (F1).**
- Select **Set Decimal Places (F5).** Select **0-4** for the appropriate decimal place for the results. Select **Close.**
- "Value/Flag":
 - Select **Value** to access "Specific Ranges" to set high (H flag) and low ranges (L flag).
 - Select **Flag** to access "Level" to set a positive limit (P flag) or negative limit (N flag), typically used for drugs of abuse testing.
- "Specific Ranges": Set a reference range to generate high (H) and low (L) flags.
 - Check 1 – 6 to enter a range based on sex and age.
 - "7 Standard demographics": Enter a generic normal range. This range is used for the sample without patient demographic information (age and gender).

- “8 Not within expected values”: This range is used for the sample with patient demographic information (age or gender), but the age or gender information did not meet the age and gender defined in the specific range 1-6.
- “Panic Value”: Set a range to generate a panic alarm and “pl” or “ph” flags (Optional).
- “Unit”: Enter units. Units print if they are formatted on the report.
- Verify the information and select **Confirm (F1)**.

6 Select **Menu List > Parameters > Calibration Parameters > Calibrators**.

- If it is necessary to program new calibrator material:
 - Select **Edit (F1)**.
 - Select an available Calibrator No. and Type.
 - Enter the Calibrator Name, ID, Lot No., and Expiration.

TIP The Calibrator Name is necessary to identify the calibrator material associated with the Calibrator No. The ID is necessary if calibrator barcode operation is in use to enter the calibrator ID. Lot No. and Expiration are optional fields.

- Verify the information and select **Confirm (F1)**.

7 Select **Calibration Specific**:

- Select the test from the "Test Name" drop-down list. Select the sample type from the "Type" drop-down list.
- Refer to the chemistry setting sheet to determine if the Calibration Type is “AB” or “MB”, and enter Calibration Specific parameters.
- If the Calibration Type is “AB”:
 - Refer to the chemistry setting sheet for Formula, Slope Check, Factor Range, Allowable Range Check, Advanced Calibration, Lot Calibration, and Stability.
 - Counts (replicates): Enter a number from 1 to 4. For more information, refer to 4.5.3 Calibration Specific Menu in the

AU480 User's Guide.

- Select the calibrator material from the "Calibrator" drop-down list.
- Enter the calibrator concentration from the package insert for "Conc."
- If the Calibration Type is "MB":
 - Refer to the chemistry setting sheet for Formula, Allowable Range Check, Advanced Calibration, MB Type Factor, and Stability.
 - Counts (replicates): Enter a number from 1 to 4. For more information, refer to 4.5.3 Calibration Specific Menu in the *AU480 User's Guide*.
- Verify the information and select **Confirm (F1)**.

TIP It is optional to calibrate from the STAT table. For additional information, refer to 4.5.4 STAT Table Calibration Menu in the *AU480 User's Guide*.

8 Select **Menu List > Parameters > QC Parameters > Controls**.

- If it is necessary to program new control material:
 - Select **Edit (F1)**.
 - Select an available Control No. and Type.
 - Enter the Control Name, ID, Lot No., Expiration, and STAT Uses.
 - Verify the information and select **Confirm (F1)**.

9 Select **QC Specific:**

- Select **Preset** tab.
- Select the test from the "Test Name" drop-down list. Select the sample type from the "Type" drop-down list.
- Select **Edit (F1)**.
 - Select the QC name from the "Control" drop-down list.
 - Select **Multi** or **Single** from the "Multi/Single" drop-down list.
 - Use the QC package insert or known values to enter the Mean, SD, and Range. QC is determined to be in or out of these preset ranges when QC Mode is set to "Preset" (on the **Check** tab.).
 - Enter the QC mean at "Mean."
 - Enter a 1 SD value at "SD."
 - Enter the value of the range at "Range." The Range is the high value minus the low value.
- Verify the information and select **Confirm (F1)**.

TIP It is optional to perform QC from the STAT table. For additional information, refer to 4.6.3 STAT Table QC Menu in the *AU480 User's Guide*.

10 Select **Menu List > System > Format > List Format**.



CAUTION

Do not change any parameter settings for items in Basic Condition, Print Information, or Layout. These parameters affect the format of the printout.

11 Select **Test Item**.

- Select **Edit (F1)**.
- The new test must be added to any required realtime printouts (reagent blank, calibration, QC, and samples) and lists in use before it will print. Select all required reports and lists from the "List Name" drop-down list. Select the test to add it to the report and/or list. The test is highlighted in blue when it is selected.
- Verify the information and select **Confirm (F1)**.

12 Select **Menu List > Parameters > Misc > Contamination Parameters**.

TIP Contact Beckman Coulter Technical Services for assay specific contamination parameter information.

- Select **Edit (F1)**.
- Program the Preceding Test Name, Following Test Name, Reagent Probe Cleaner Kind, Wash Count, Effective of Water Cleaning, Mixer, and Cuvette if additional contamination prevention parameters are required.

13 If online communication with a laboratory information (host) system or middleware system is in use, it is necessary to program an online test number. Select **Menu List > System > Online > Online Test No.**

- Select **Edit (F1)**.
- Enter the "Online Test No.". The combination of the online test number and test must coincide with the clinical laboratory host system. Set the number as a blank when online communication is not required.
- Verify the information and select **Confirm (F1)**.

TIP When the test number of the host system and the online test number differ, the data may not be transmitted correctly.

14 Run the test to verify the programming of the new test(s).

- Load the reagent and any required cleaning solution on the analyzer.
- Perform a reagent volume check.
- Verify that calibration is requisitioned for the new test(s).
- Requisition QC on the new test(s) if the test(s) was not added to the default QC requisition.
- Perform a reagent blank, calibration, and QC on the new test(s).
- Review the printout and verify the reagent blank, calibration, and QC data.

6.2 Create a Profile

A profile is a group of tests that are usually requested at the same time. Using a profile reduces the number of key strokes needed, as a single profile is selected instead of multiple tests. A maximum of 100 profiles (Number 0 to Number 99) can be registered for samples, reagent blank, calibration, and QC. A maximum of 99 tests can be programmed in a profile. The number of tests that can be programmed in a profile is limited by the number of sample blank tests, LIH, and sample type.

Each profile is assigned a profile name.

TIP Profile 0 is the Default profile in the **Sample** tab. Profile 0 can be automatically performed in the following situations:

- There is a barcode read error.
- There is no requisition found for a sample.
- There are online errors.

Contact Beckman Coulter Technical Services for additional information.

TIP Tests that are grayed out cannot be selected.

ISE tests can be selected only when the sample type is "Serum" or "Urine."

6.2.1 Create a Sample Profile

- 1 Select **Menu List > Parameters > Common Test Parameters > Profile > Sample**.

Figure 6.1

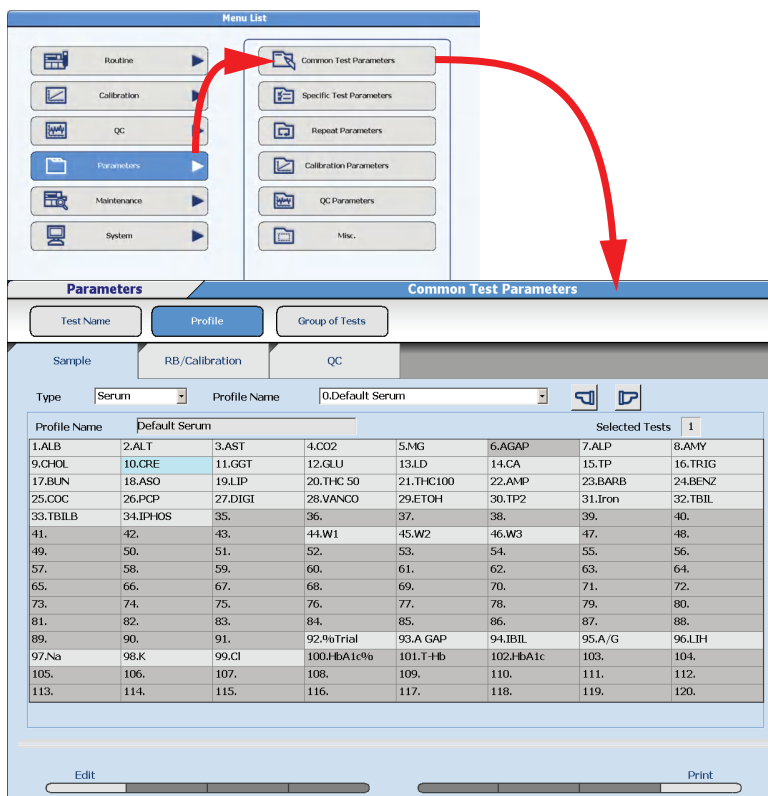

- 2 Select **Edit (F1)**.
- 3 Select the sample type from the "Type" drop-down list.
- 4 At the "Profile Name" drop-down, enter a profile number 0 to 99.

- 5 At **Profile Name**, enter a profile name with a maximum of 20 characters.
- 6 Select the test(s) to be included in the profile. Selected tests appear in blue.
- 7 Select **Confirm (F1)**.

6.2.2 Create a Reagent Blank or Calibration Profile

TIP The programming in **Calibration Specific** determines the calibration options available in **Calibration Options (F5)**.

Tests that are grayed out cannot be selected.

ISE tests can be selected when the ISE calibration type is “ACAL.”

- 1 Select **Menu List > Parameters > Common Test Parameters > Profile > RB/Calibration**.

Figure 6.2

The screenshot shows the 'Common Test Parameters' window. At the top, there are tabs for 'Parameters' and 'Common Test Parameters'. Below these are buttons for 'Test Name', 'Profile', and 'Group of Tests'. The 'Profile' button is selected. Underneath, there are tabs for 'Sample', 'RB/Calibration', and 'QC'. The 'RB/Calibration' tab is active. A 'Profile Name' field contains '0.Daily Serum Cal'. Below this is a table with columns for 'Profile Name', 'Daily Serum Cal', 'Type', 'Serum', and 'Selected Tests'. The table lists 20 tests, with some cells highlighted in yellow (4.CO2, 5.MG, 10.CRE) and others in blue (6.AGAP, 101.T-Hb, 102.HbA1c). At the bottom of the table, there are three buttons: 'ACAL + RB' (yellow), 'Use Profile' (green), and 'RB Only' (blue). At the very bottom of the window, there are 'Edit' and 'Print' buttons.

| Profile Name | Daily Serum Cal | Type | Serum | Selected Tests |
|--------------|-----------------|----------|----------|----------------|
| 1.ALB | 2.ALT | 3.AST | 4.CO2 | 5.MG |
| 6.AGAP | 7.ALP | 8.AMY | 9.CHOL | 10.CRE |
| 11.GGT | 12.GLU | 13.LD | 14.CA | 15.TP |
| 16.TRIG | 17.BUN | 18.ASO | 19.LIP | 20.THC 50 |
| 21.THC100 | 22.AMP | 23.BARB | 24.BENZ | 25.COC |
| 26.PCP | 27.DIGI | 28.WANCO | 29.ETOH | 30.TP2 |
| 31.Iron | 32.TBIL | 33.TBILB | 34.IPHOS | 35. |
| 36. | 37. | 38. | 39. | 40. |
| 41. | 42. | 43. | 44.W1 | 45.W2 |
| 46.W3 | 47. | 48. | 49. | 50. |
| 51. | 52. | 53. | 54. | 55. |
| 56. | 57. | 58. | 59. | 60. |
| 61. | 62. | 63. | 64. | 65. |
| 66. | 67. | 68. | 69. | 70. |
| 71. | 72. | 73. | 74. | 75. |
| 76. | 77. | 78. | 79. | 80. |
| 81. | 82. | 83. | 84. | 85. |
| 86. | 87. | 88. | 89. | 90. |
| 91. | 92.%Trial | 93.A GAP | 94.IBIL | 95.A/G |
| 96.LIH | 97.Na | 98.K | 99.Cl | 100.HbA1c% |
| 101.T-Hb | 102.HbA1c | 103. | 104. | 105. |
| 106. | 107. | 108. | 109. | 110. |
| 111. | 112. | 113. | 114. | 115. |
| 116. | 117. | 118. | 119. | 120. |

-
- 2 Select **Edit (F1)**.

 - 3 Select the sample type from the "Type" drop-down list.

 - 4 At the "Profile Name" drop-down, enter a profile number 0 to 99.

 - 5 At **Profile Name**, enter a profile name with a maximum of 20 characters.

 - 6 Select the test(s) to be included in the profile. The test highlights in blue (RB Only), yellow (ACAL + RB), or green (One Point) based on programming in **Calibration Specific**. Select **Calibration Options (F5)** to change between the available options.

 - 7 Select **Confirm (F1)**.
-

6.2.3 Create a QC Profile

TIP QC profiles 87 to 98 are the default QC profiles that are automatically requisitioned in **Home > Rack Requisition Sample > QC**. The QC profile numbers 87 to 98 correspond to a specific Group and sample type:

- Number 87: Serum: For Group 1
- Number 88: Serum: For Group 2
- Number 89: Serum: For Group 3
- Number 90: Urine: For Group 1
- Number 91: Urine: For Group 2
- Number 92: Urine: For Group 3
- Number 93: Other-1: For Group 1
- Number 94: Other-1: For Group 2
- Number 95: Other-1: For Group 3
- Number 96: Other-2: For Group 1
- Number 97: Other-2: For Group 2
- Number 98: Other-2: For Group 3

TIP Tests that are grayed out cannot be selected.

- 1 Select **Menu List > Parameters > Common Test Parameters > Profile > QC.**

Figure 6.3

| Profile Name | Type | Serum | Selected Tests | | | | |
|--------------|-----------|----------|----------------|----------|----------|----------|----------|
| 1.ALBPI | 2.ALBPo | 3.LDHI | 4.LDHo | 5.IPNI | 6.IPNo | 7.GLUI | 8.GLUo |
| 9.ALPI | 10.ALPo | 11.AMYI | 12.AMYo | 13.ALTI | 14.ALTo | 15.ASTI | 16.ASTo |
| 17.MGI | 18.MGo | 19.GGTI | 20.GGTi | 21.CAI | 22.CAo | 23.CHEI | 24.CHEo |
| 25.CKI | 26.CKo | 27.FEI | 28.FEo | 29.TPI | 30.TPo | 31.TBILI | 32.TBILo |
| 33.DBILI | 34.DBILo | 35.UAI | 36.UAo | 37.UNI | 38.UNo | 39.CREI | 40.CREo |
| 41.CHOI | 42.CHOo | 43.TGI | 44.TGo | 45.HDLI | 46.HDLi | 47.LDLI | 48.LDLo |
| 49.CRPI | 50.CRPo | 51.ALBGI | 52.ALBGo | 53.CHOHI | 54.CHOHo | 55.CHOII | 56.CHOIo |
| 57.CHOIHI | 58.CHOIHo | 59.TGHI | 60.TGHo | 61.UALI | 62.UALo | 63.UAII | 64.UAIo |
| 65.UAII | 66.UAIIo | 67. | 68. | 69. | 70. | 71. | 72. |
| 73. | 74. | 75. | 76. | 77. | 78. | 79. | 80. |
| 81. | 82. | 83. | 84. | 85. | 86. | 87. | 88. |
| 89. | 90. | 91. | 92. | 93. | 94. | 95. | 96.LIHI |
| 97.Na | 98.K | 99.Cl | 100. | 101. | 102. | 103. | 104. |
| 105. | 106. | 107. | 108. | 109. | 110. | 111. | 112. |
| 113. | 114. | 115. | 116. | 117. | 118. | 119. | 120. |

- 2 Select **Edit (F1).**
- 3 Select the sample type from the "Type" drop-down list.
- 4 At the "Profile Name" drop-down, enter a profile number 0 to 98.
- 5 At **Profile Name**, enter a profile name with a maximum of 20 characters.
- 6 Select the test(s) to be included in the profile. Selected tests appear in blue.
- 7 Select **Confirm (F1).**

6.3 Program Calibrator Concentrations

Use this function to verify and change calibrator concentrations. Select the calibrator name to verify and change the concentrations of all tests in a calibrator from the same screen. This is the easiest way to change all concentrations when the calibrator lot number changes.



Confirm calibrator concentration values in Calibration Specific.

IT IS CRITICAL ALL CALIBRATOR VALUES ARE ENTERED CORRECTLY.

For details on calibration specific test parameters, refer to 4.5.3 Calibration Specific Menu in the *AU480 User's Guide*, chapter 4.

- 1** Select **Menu List > Parameters > Calibration Parameters > Calibrators**.
- 2** Select **Edit (F1)**. The window changes to the edit mode.
- 3** Select the calibrator name to edit from the "Calibrator" drop-down list.

- 4 Select **Set Conc Value (F5)**. The Set Conc Value window opens.

Figure 6.4

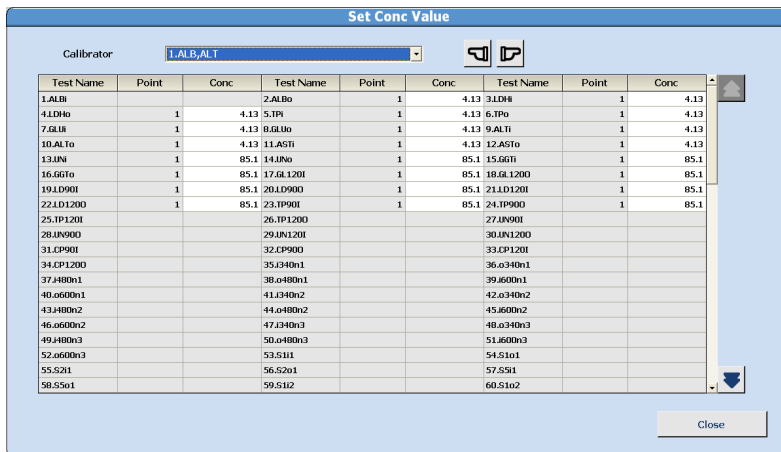

- 5 The concentration value(s) of the selected calibrator display. To display or edit a different calibrator, select the calibrator name from the "Calibrator" drop-down list.
- 6 Enter the concentration values (Conc) for each test (Test Name) in the calibrator. The concentration values can only be entered for tests programmed to the calibrator in **Calibration Specific**.
- 7 Repeat steps 5 and 6 for any other calibrator to verify or change the concentration.
- 8 Select **Close** to close the Set Conc Value window.
- 9 If a calibrator concentration was changed, a confirmation message appears in the Set Conc Value window. Select **OK**.

As Needed Tasks

6.3 Program Calibrator Concentrations

10 Select **Confirm (F1)**.

6.4 Program Preset QC Mean and Range

Use this procedure to verify and change the QC mean, standard deviation, and range. For detailed information on QC parameters, refer to 4.6.2 QC Specific Menu in the *AU480 User's Guide*, chapter 4.

- **1** Select **Menu > Parameters > QC Parameter > QC Specific > Preset**.
- **2** Select the test name from the "Test Name" drop-down list.
- **3** Select the sample type from the "Type" drop-down list.
- **4** Select **Edit (F1)**.
 - Select the QC name from the "Control" drop-down list.
 - Select **Multi** or **Single** from the "Multi/Single" drop-down list.
 - Use the QC package insert or known values to enter the Mean, SD, and Range. QC is determined to be in or out of these preset ranges when QC Mode is set to "Preset" (on the **Check** tab).
 - Enter the QC mean at "Mean."
 - Enter a 1 SD value at "SD."
 - Enter the value of the range at "Range." The Range is the high value minus the low value.
- **5** Verify the information and select **Confirm (F1)**.

6.5 Program the Automatic Startup Function

The lamp requires approximately 20 minutes to warm up after power ON before analysis can be started.

The system can be programmed to turn ON automatically at a specified time for each day of the week.



The automatic ON option does not open and close the main water valve, so it must be left open. Follow laboratory Standard Operating Procedures for inspecting the DI water system and main water valve.

- 1 Select **Menu List > System > System Condition > Auto Power On**.

Figure 6.5

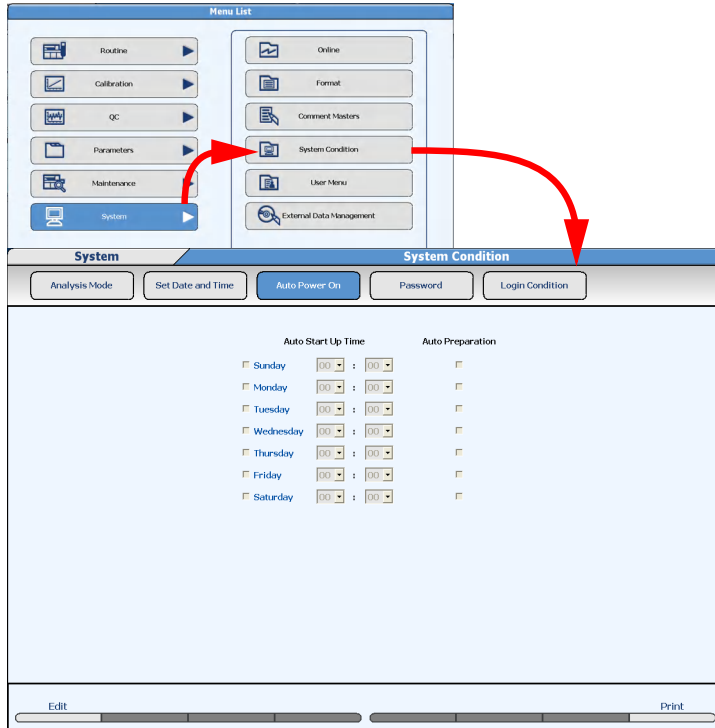

- 2 Select **Edit (F1)**.
- 3 Select the check box of the desired day to perform the Auto Power On function.
- 4 Set “Hours” and “Minutes” from the drop-down list.

As Needed Tasks

6.5 Program the Automatic Startup Function

5 To perform Auto Preparation, select the “Auto Preparation” check box.

TIP The ability to perform “Auto Preparation” is enabled for each day of the week in System Maintenance by Beckman Coulter Technical Services. The three auto preparation options are:

- W1
- Photocal
- W1 + Photocal

Once System Maintenance is enabled, check the day of the week to perform the Auto Preparation.

6 Repeat steps 3 to 5 for each day to be set.

7 Select **Confirm (F1)**. The programming is registered.

6.6 Program a User Menu

The User Menu function allows the selection of up to 16 menus most frequently used by the operator. User-defined menu names can be programmed. Menus selected from the **User Menu** button have direct access to the menu to save time.

TIP The original menu name displays below the main button bar even when menus are accessed by the **User Menu** button.

6.6.1 Edit the User Menu

- 1 Select **Menu List > System > User Menu**.

Figure 6.6

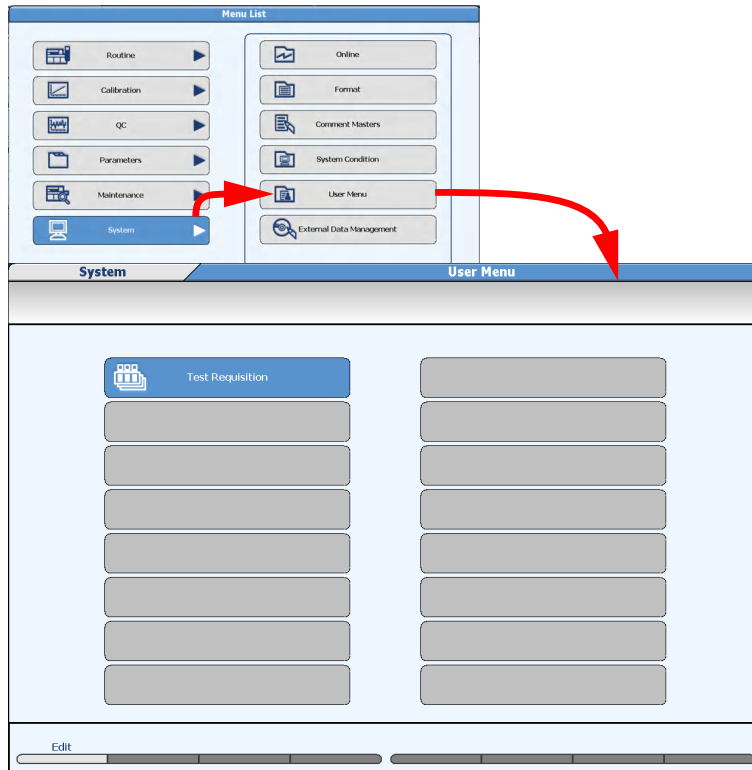

- 2 Select **Edit (F1)**. The next available menu to program changes from the gray box to a blue button.

-
- 3 Select the blue button. The User Menu window opens.

Figure 6.7

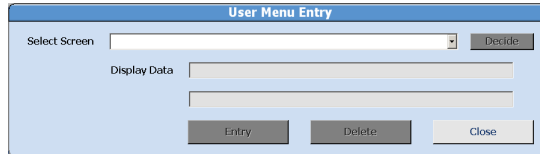

-
- 4 From the “Select Screen” drop-down list, select the menu to put in the **User Menu** list.

-
- 5 Select **Decide**.

-
- 6 For Display Data, enter the user-defined menu name. Up to 28 characters can be entered on each of the two lines.

-
- 7 Select **Entry**.

-
- 8 Select **Confirm (F1)**. The programming is registered.
-

6.6.2 Delete

To remove a menu from the **User Menu**:

-
- 1 Select **Menu List > System > User Menu**.

-
- 2 Select **Edit (F1)**.

-
- 3 Select the Menu to be deleted. The User Menu window opens.

-
- 4 Select **Delete**. The specified menu is deleted.

As Needed Tasks

6.6 Program a User Menu

5 Select **Confirm (F1)**.

6.7 Print Results

To print test results in the form of report or data log list, the report format must be programmed in advance.

For details on how to program a report format, refer to 4.14.1 Format Realtime Reports and Lists in the *AU480 User's Guide*, chapter 4.

6.7.1 Print Sample Data Reports

TIP The report format must be programmed in advance.

Users can select and print any available predefined report, according to the format selected in step 6.

1 Select **Home > Sample Manager > Main.**

Figure 6.8

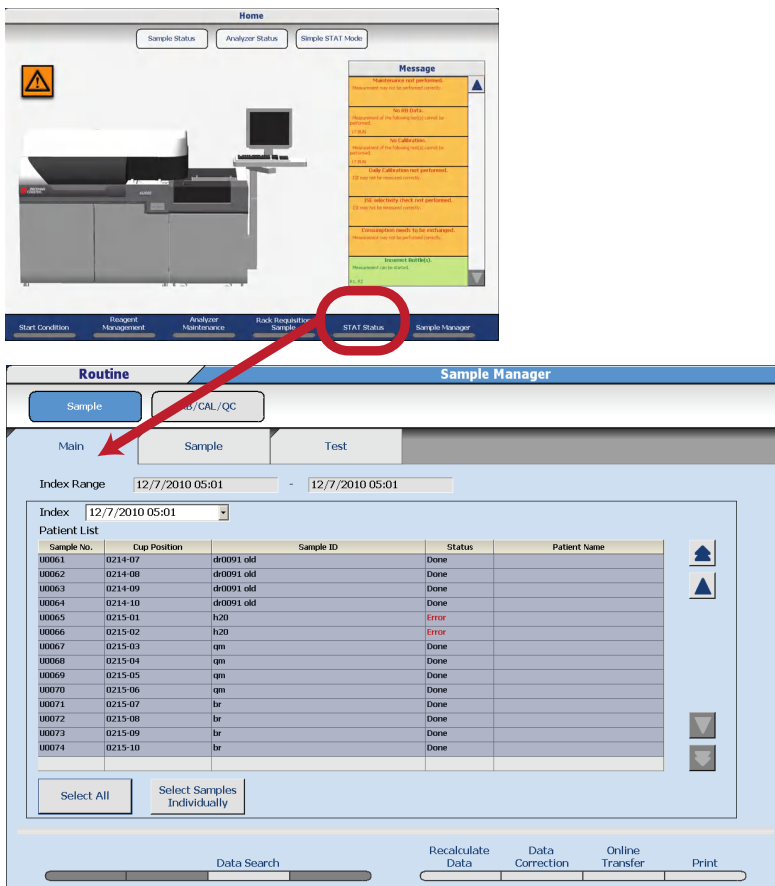

2 The data from the current index displays. All samples are selected to print (highlighted in gray). Use **Select All** and **Select Samples Individually** as required.

-
- 3** Select **Data Search (F3)** to search for data by an Index Range, Sample Number(s), Sample ID, Data Not Transferred to Host, Data Not Printed, or Abnormal data.

 - 4** Select **OK**.

 - 5** Select **Print (F8)**. The Print window opens.

 - 6** Select the report to print from the "Data List No." drop-down list.

 - 7** For Reporter, the Operator Name entered in **Start Condition** displays. If necessary, enter a new name or use **Select** to enter a pre-programmed comment. "Reporter" is an option that can be added to a list format, and only prints if it is formatted.

 - 8** Select **OK**. Printing begins.
- TIP** Select **Print Stop (F8)** to abort printing.
-

6.7.2 Print Reagent Blank, Calibration, and QC Results

- 1 Select **Home > Sample Manager > RB/CAL/QC**.

Figure 6.9

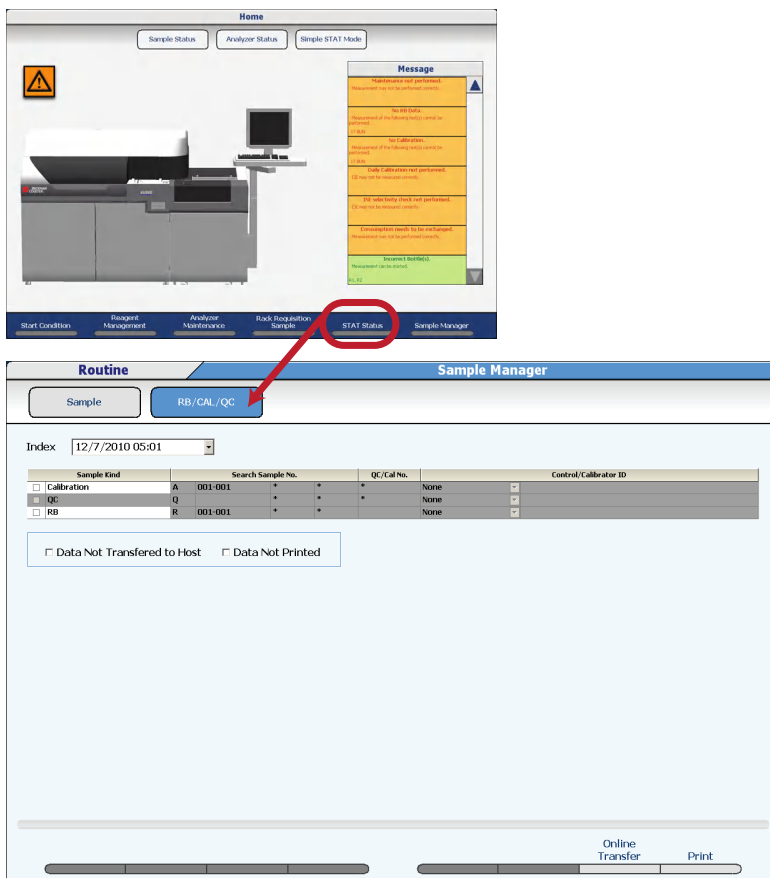

- 2 Select the index of the RB/CAL/QC data to search from the “Index” drop-down list.

- 3 Select the “Sample Kind” check box of the samples desired.

4 For “Search Sample No.”, enter the sample number range to print, or leave the “*” to print all samples.

TIP If the “Search Sample No.” is left blank or empty, no search criteria is used to perform the search.

5 For “QC/Cal. No.”, enter the QC number (1 to 100) or the calibrator number (1 to 200), or leave the “*” to print all QC and calibrator numbers.

6 For “Control / Calibrator ID”, enter the QC or calibrator barcode number to print samples with a specific QC or calibrator ID.

7 Check the “Data Not Transferred to Host” box to print only the samples that have not been transferred to the host. Check the “Data Not Printed” box to print only the samples that have not been printed.

8 Select **Print (F8)**.

9 Select the report to print from the "Data List No." drop-down list.

TIP For **Reporter**, the Operator Name entered in **Start Condition** displays. If necessary, enter a new name or use **Select** to enter a pre-programmed comment. “Reporter” is an option that can be added to a list format, and only prints if it is formatted.

10 Select **OK**. This list begins printing.

TIP Select **Print Stop (F8)** to abort printing.

6.8 Transfer Data to Host Computer

Reagent blank, calibration, QC, and sample data can be transferred to a host computer system.



Before transfer, confirm that the system is online and connected to a clinical laboratory host computer system.

6.8.1 Sample Data

Batch data transfer to a host computer.

TIP Online Transfer (F7) is only available when the Online menu is programmed to Realtime or Batch for Results Transfer. If Realtime is programmed, data can only be transferred in *Standby*.

- 1 Select **Home > Sample Manager > Main**.

Figure 6.10

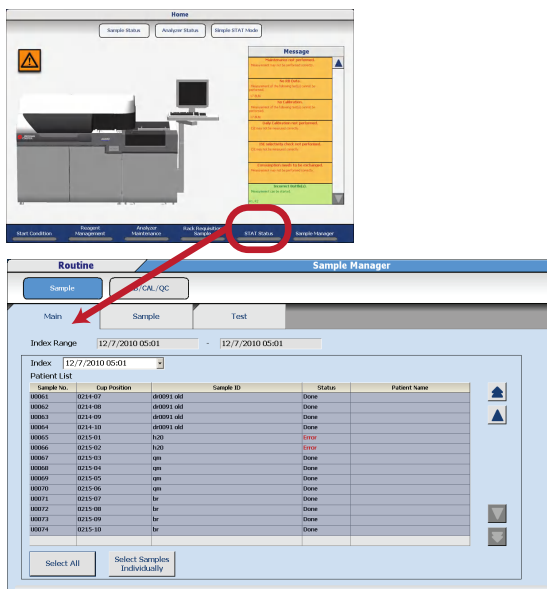

-
- 2** The data from the current index displays with all samples selected (highlighted in gray). Use **Select All** and **Select Samples Individually** as required.
-
- 3** Select **Data Search (F3)** to search for data by an Index Range, Sample Number(s), Sample ID, Data Not Transferred to Host, Data Not Printed, or Abnormal data. Select **OK**.
-
- 4** Select **Online Transfer (F7)**. The Online Transfer window opens.
-
- 5** Select **OK**. The data is transferred.
TIP An “r” flag is attached to data that has been transferred to the host computer.
-

6.8.2 Reagent Blank, Calibration, and QC Data

Batch data transfer to a host computer.

TIP **Online Transfer (F7)** is only available when the Online menu is programmed to Realtime or Batch for Results Transfer. If Realtime is programmed, data can only be transferred in *Standby*.

-
- 1** From the **RB/CAL/QC** screen, select the samples and criteria to transfer.
-
- 2** Select **Online Transfer (F7)** to display the Online Transfer window.
-
- 3** Select **OK**. Online transfer is performed.
TIP Select **Online Transfer Stop (F7)** to stop the transfer.
-

6.9 Fix (Assign) a Reagent Position

Fix (assign) reagents that are not barcoded. The analyzer does not read barcodes on reagents in fixed positions.

Non-barcoded reagents must be placed in the assigned reagent position.

Reagent ID Read Errors only display in the **Details** tab when “Reagent Display” is set to Position.

- 1** Select **Home > Reagent Management > Details**.
TIP Reagent Status may have to be “checked” before a position can be fixed. Select **Reagent Check (F5) > “Reset”**. Use **Reset** only if no other changes have been made.
- 2** Select **Position** from the "Reagent Display" drop-down list.
- 3** Select an available bottle position to fix the reagent.
- 4** Select **Position Setting (F2)**.

Figure 6.11

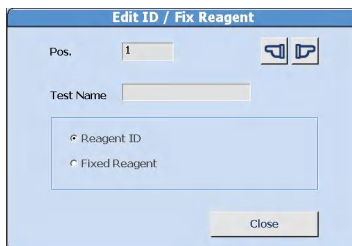

- 5** Select **Fixed Reagent** then **Close**. A blue box with an “*” displays to the left of “Pos.” for fixed reagents.

6 Select **Edit (F1)**.

Figure 6.12

TIP Fields a, b, and e are required. Fields c and d are optional based on laboratory Standard Operating Procedures.

- a. Select the test name from the "Test Name" drop-down list.
- b. R1 (R1-1) or R2 (R2-1) displays from the "Type" drop-down list.
- c. Enter a Lot No. according to laboratory Standard Operating Procedures.
- d. Enter a Bottle No. (SN) according to laboratory Standard Operating Procedures.
- e. Select a bottle size from the "Bottle Size" drop-down list.

7 Select **Close**. Repeat steps 3-6 if the reagent has both an R1 and an R2.

8 Verify a blue box with an "*" displays to the left of "Pos." for fixed reagents.

9 Select **Reagent Check (F5) > Check Specified Positions**, then select the reagent(s) loaded into the fixed positions to update the test count.

6.10 Edit a Reagent ID

Edit the reagent ID after a reagent ID read error occurs on a barcoded reagent bottle.

A notification alarm occurs during the reagent check (“Reagent ID Read Error”), and the Comment “ID Edit” displays until the reagent bottle is removed from the refrigerator.

- 1 Select **Home > Reagent Management > Details**.
- 2 Select **Position** from the "Reagent Display" drop-down list.
- 3 Place the cursor on the position with the reagent ID read error.
- 4 Select **ID Edit (F3)**.

Figure 6.13

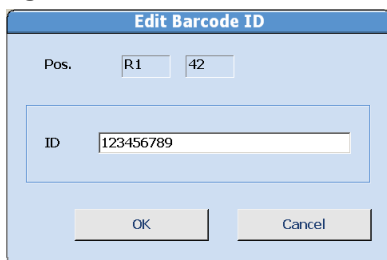

The screenshot shows a dialog box titled "Edit Barcode ID". It has a light blue background and a white border. At the top, there is a title bar with the text "Edit Barcode ID". Below the title bar, there are two input fields for "Pos." with the values "R1" and "42". Below these is a larger input field for "ID" containing the value "123456789". At the bottom of the dialog, there are two buttons: "OK" and "Cancel".

- 5 Type in the 20-digit reagent ID from the reagent bottle. Select **OK**. The on-board stability, expiration, lot number, and bottle number are updated with a “No Volume to Process” comment.
- 6 Select **Reagent Check (F5) > Check Specified Positions** to update the test count. An advisory alarm “Reagent ID Read Error” and “ID Edit” comments display. The RB stability and cal stability are updated.

6.11 Reagent Inventory

Reagent volume required for each test by the day of the week can be calculated from data obtained from the analyzer (Auto), or a value can be entered for each test and day of the week (Manual).

Reagent Inventory displays the number of test shots used each day of the week for each sample type within the period set by the index range. Use **Reagent Inventory** to determine how much reagent should be on-board for each day of the week.

The blue indicator bar in **Reagent Management > Main** displays the maximum number of tests calculated in **Reagent Inventory**.

6.11.1 Auto Calculation of Reagent Inventory

- 1 Select **Home > Reagent Management > Reagent Inventory > Auto**.

Figure 6.14

The screenshot shows the 'Reagent Inventory' window with the 'Auto' mode selected. The index range is set from 01/14/2010 09:26 to 03/04/2010 06:02. The table below displays the calculated reagent volumes for 20 different tests over a seven-day period.

| Test Name | Reagent ID | Monday | Tuesday | Wednesday | Thursday | Friday | Saturday | Sunday |
|-----------|------------|--------|---------|-----------|----------|--------|----------|--------|
| 1.Alb | 002 | 0 | 0 | 0 | 237 | 80 | 0 | 0 |
| 2.ALp | 004 | 142 | 0 | 0 | 137 | 80 | 0 | 0 |
| 3.ALt | 007 | 142 | 0 | 0 | 214 | 80 | 0 | 0 |
| 4.NH4 | 154 | 0 | 0 | 0 | 214 | 80 | 0 | 0 |
| 5.Amy | 006 | 142 | 0 | 0 | 214 | 80 | 0 | 0 |
| 6.AST | 009 | 142 | 0 | 0 | 214 | 80 | 0 | 0 |
| 7.CO2 | 037 | 13 | 37 | 16 | 202 | 51 | 0 | 0 |
| 8.DBIL2R | 181 | 0 | 0 | 0 | 137 | 80 | 0 | 0 |
| 9.DBIL | 011 | 6 | 34 | 13 | 127 | 49 | 0 | 0 |
| 10.TBIL | 012 | 6 | 59 | 15 | 127 | 49 | 0 | 0 |
| 11.CaArs | 117 | 0 | 0 | 0 | 214 | 80 | 0 | 0 |
| 12.CoOPC | 013 | 0 | 0 | 0 | 214 | 80 | 0 | 0 |
| 13.Chol | 016 | 4 | 25 | 10 | 0 | 140 | 0 | 0 |
| 14.HDL | 095 | 0 | 0 | 0 | 0 | 262 | 0 | 0 |
| 15.LDL | 096 | 0 | 0 | 0 | 0 | 262 | 0 | 0 |
| 16.CKMB | 0 | 0 | 0 | 0 | 0 | 261 | 0 | 0 |
| 17.CPK | 079 | 142 | 0 | 0 | 0 | 261 | 0 | 0 |
| 18.Creat | 078 | 13 | 35 | 18 | 0 | 142 | 0 | 0 |
| 19.GGT | 019 | 52 | 26 | 11 | 0 | 109 | 0 | 0 |
| 20.Gluc | 021 | 4 | 28 | 12 | 0 | 111 | 0 | 0 |

TIP Auto calculations can be entered one day in advance.

Display Range (F3)

Sets the starting and ending indexes to calculate the reagent usage.

Change Reagent Type (F5)

Changes the display from R1 -1 to R1-2 reagent. Only available when "R1 Volume" is selected.

2 Select the sample type from the "Type" drop-down list.

3 Select **Display Range (F3)**. The Display Range window opens.

Figure 6.15

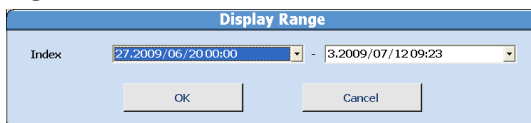

4 Select the start index and the end index from each drop-down list.

5 Select **OK**. The number of tests selected within the index range is displayed on the list.

6 Select **R1 Volume** or **R2 Volume**. The reagent consumption is automatically calculated based on an actual result and then displayed on the list by mL.

The reagent consumption is calculated by the following formula:

Actual result * (the amount of reagent dispensing + the amount of surplus dispensing).

7 Select **Auto** from the "Decision" drop-down list. The calculated reagent consumption is set as the required reagent volume indicator in **Reagent Management**.

6.11.2 Manual Calculation of Reagent Inventory

- 1 Select **Home > Reagent Management > Reagent Inventory > Manual**.
- 2 Select **Edit (F1)**. The window changes to the edit mode.
- 3 Select the sample type from the "Type" drop-down list.
- 4 Enter the number of tests run for each test for each day of the week.
- 5 Select **Confirm (F1)**. The window changes to reference mode.
- 6 Select **R1 Volume** or **R2 Volume**. The reagent consumption input is automatically calculated based on entered test numbers and then displayed on the list by mL.
- 7 Select **Manual** from the "Decision" drop-down list. The test count entered for reagent consumption is set as the required reagent volume indicator in **Reagent Management**.

6.12 Reagent Consumption

Reagent Consumption displays the amount of reagent used for each test programmed on the analyzer.

Set a range of indexes to display the reagent consumption used for analysis for each test by sample type.

- 1 Select **Home > Reagent Management > Reagent Consumption**.

Figure 6.16

| Test Item | Reagent ID | Routine | Emergency | STAT | Sub Total | Repeat | RB | ACAL | QC | Total |
|----------------|------------|---------|-----------|------|-----------|--------|-------|-------|-----|--------|
| Total | | 163392 | 0 | 143 | 163535 | 1310 | 14000 | 31140 | 110 | 210191 |
| Samples | | | | | | | | | | |
| ALB | 002 | 2099 | 0 | 0 | 2099 | 20 | 240 | 236 | 10 | 3405 |
| AFP | 004 | 2474 | 0 | 2 | 2476 | 14 | 266 | 0 | 0 | 2756 |
| ALT | 007 | 2466 | 0 | 1 | 2467 | 18 | 274 | 0 | 18 | 2777 |
| AMY | 006 | 2793 | 0 | 1 | 2794 | 52 | 312 | 0 | 0 | 3150 |
| AST | 009 | 2461 | 0 | 1 | 2462 | 3 | 302 | 0 | 0 | 2767 |
| UGG | 037 | 1956 | 0 | 13 | 1969 | 7 | 332 | 656 | 0 | 2964 |
| CADPC | 013 | 2394 | 0 | 0 | 2394 | 2 | 320 | 636 | 0 | 3352 |
| CA-AR | 117 | 2500 | 0 | 0 | 2500 | 2 | 284 | 568 | 0 | 3354 |
| CHOL | 016 | 2140 | 0 | 1 | 2141 | 1 | 324 | 320 | 14 | 2800 |
| HDL | 095 | 1940 | 0 | 0 | 1940 | 1 | 192 | 188 | 2 | 2323 |
| CK | 096 | 1726 | 0 | 0 | 1726 | 7 | 100 | 172 | 0 | 2005 |
| CKE | 014 | 892 | 0 | 0 | 892 | 17 | 100 | 4 | 0 | 1013 |
| CK | 079 | 2444 | 0 | 0 | 2444 | 5 | 278 | 0 | 0 | 2722 |
| CK-MB | 135 | 0 | 0 | 0 | 0 | 0 | 0 | 0 | 0 | 0 |
| UGGAT | 078 | 2246 | 0 | 0 | 2246 | 15 | 320 | 624 | 2 | 3207 |
| GGT | 019 | 2602 | 0 | 0 | 2602 | 15 | 290 | 0 | 0 | 2907 |
| GLU | 021 | 2592 | 0 | 2 | 2594 | 1 | 316 | 312 | 12 | 3235 |
| HPROS | 022 | 1673 | 0 | 0 | 1673 | 21 | 216 | 216 | 0 | 2126 |
| IRON | 086 | 1943 | 0 | 0 | 1943 | 12 | 184 | 184 | 0 | 2323 |
| UREA | 205 | 1510 | 0 | 0 | 1510 | 19 | 140 | 146 | 0 | 1825 |

TIP Reagent Consumption defaults to display **Shot Total**.

The **Shot Total** is the cumulative number of tests run on the analyzer from the installation of the instrument.

- 2 Select the sample type from the "Type" drop-down list.
- 3 Select **Display Range (F3)**.
- 4 Select the start index and the end index from each drop-down list.

-
- 5 Select **OK**. The number of cumulative tests is displayed.
-

6.12.1 Check Reagent Consumption by Samples Measured and Reagent Dispense

-
- 1 Select **Test Shots** after setting the index range and sample type. The number of actual reagent dispenses, including repeat tests and re-analyzed tests displays for each test and sample type. The number of Samples displays for Routine, Emergency, STAT, and Repeat. The number of ISE samples displays.
-

- 2 Select **R1 Volume** or **R2 Volume**.
The volume in mL of reagent dispensed for each test and sample type displays.

The reagent consumption is calculated by the following formula:

Actual analysis result * (the amount of reagent dispensing + the amount of surplus dispensing)

-
- 3 Select **Test Total** after setting the index range and sample type. The number of analyzed tests not including repeat tests and re-analyzed tests displays for each test and sample type. The number of Samples displays for Routine, Emergency, STAT, and Repeat. The number of ISE tests (Na, K, and Cl) displays.
-

6.12.2 Save Reagent Consumption Data

-
- 1 Select **Report (F7)**.
-

- 2 Select **FD**, **CD-R**, or **External Memory Stick**.

As Needed Tasks

6.12 Reagent Consumption

3 Select the starting and ending index to save data from the "Start Index" and "End Index" drop-down lists.

4 Select **OK**. The reagent consumption data is saved as a csv file.

6.13 Edit Quality Control Data

Analyzed QC data can be reviewed and edited.

Editing, deleting, or adding a comment can be performed by QC sample number or test.



Analyzed QC results can be edited. To prevent an erroneous diagnosis due to numerous changes to the quality control data, editing should be done according to laboratory Standard Operating Procedures.

TIP When the QC analysis data results have been edited, confirm that the edited data falls within the cumulative period. If it falls within the cumulative period, the editing of the contents must be reflected in the cumulative values. To reflect the editing of contents in the cumulative values, update the cumulative values. Refer to 4.6.2 QC Specific Menu in the *AU480 User's Guide*, chapter4 for updating and calculating cumulative QC values.

TIP When test results have been edited, an “e” flag is added to the Data Flags. Once an “e” flag has been added, it cannot be deleted. When a “d” flag is added to the Data Flags, the data is not included in the QC statistic calculations.

- 1 Select **Menu List > QC > QC Data Review > Main.**

Figure 6.17

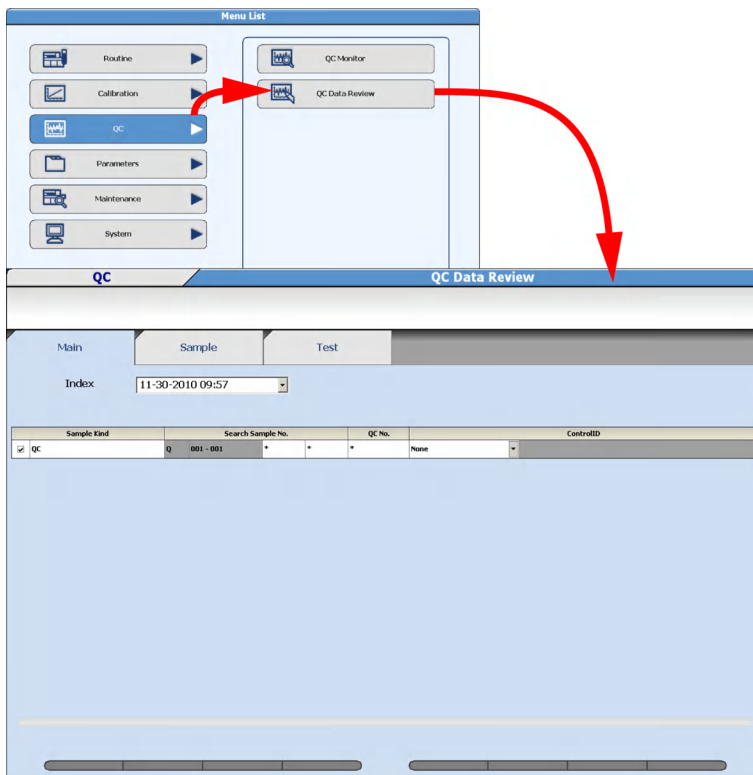

- 2 Select the required index from the “Index” drop-down list.
- 3 Place a check mark by QC in the Sample Kind column. Set the search range by entering the Search Sample No., the QC No., and the Control ID. The “*” searches for all data.
- 4 Select the **Sample** or **Test** tab to display the search results. A message window displays if no results are found. Select **OK** to return to the **Main** tab.

5 Select the **Sample** tab to edit QC by QC sample number.

Figure 6.18

QC Data Review

Main Sample Test

Index 11-30-2010 09:57 <Editing>

QC Sample No. Q 001 Type Serum

| Test Name | Level | Control | Result | Data Flag | SD Range |
|-----------|-------|---------------------|--------|-----------|----------|
| 2.AST /1 | 1 | 1.ChemTrack Level 1 | 23 | | 1 |
| 2.ALT /1 | 2 | 2.ChemTrack Level 3 | 170 | d | 1 |
| 3.AST /1 | 1 | 1.ChemTrack Level 1 | 19 | | + |
| 3.ALT /1 | 2 | 2.ChemTrack Level 3 | 100 | | + |
| 12.GLU /1 | 1 | 1.ChemTrack Level 1 | 57 | | 1 |
| 12.GLU /2 | 2 | 2.ChemTrack Level 3 | 261 | | + |
| 17.BUN /1 | 1 | 1.ChemTrack Level 1 | 15 | | + |
| 17.BUN /2 | 2 | 2.ChemTrack Level 3 | 53 | | + |
| 97Na | 1 | 1.ChemTrack Level 1 | 127 | G | 1 |
| 97Na | 2 | 2.ChemTrack Level 3 | 152 | G | 1 |
| 98K | 1 | 1.ChemTrack Level 1 | 3.1 | | + |
| 98K | 2 | 2.ChemTrack Level 3 | 6.1 | | + |
| 99.Cl | 1 | 1.ChemTrack Level 1 | 82 | 1Q | 4 |
| 99.Cl | 2 | 2.ChemTrack Level 3 | 115 | 1Q | 2 |

Confirm Delete Index Comment Test Comment Reagent Information

- Select **Edit (F1)**.
- To edit a test(s) in the sample, select the Result or Data Flag to edit. To delete a test(s) enter a “d” flag in Data Flag.
- To delete the entire QC sample (Q001, for example, includes all controls in the first QC run), select **Delete (F2)**. A “d” flag is attached to all tests in the sample. Select **OK** in the Confirmation window.
- To edit a comment, select **Index Comment (F3)** or **Test Comment (F4)**.
- Select **Confirm (F1)** to program the QC edits or deletions.

6 Select the **Test** tab to edit QC by test.

Figure 6.19

The screenshot shows the 'QC Data Review' window. At the top, there are tabs for 'Main', 'Sample', and 'Test'. Below the tabs, the 'Index' is set to '06-24-2010 09:58' and the 'Test Name' is '9.CHOL'. A table displays QC data with columns for 'QC Sample No.', 'Type', 'Level', 'Control', 'Result', 'Data Flag', and 'SD Range'. The table contains four rows of data for samples Q001 and Q002. At the bottom, there are buttons for 'Confirm', 'Index Comment', 'Test Comment', and 'Reagent Information'.

| QC Sample No. | Type | Level | Control | Result | Data Flag | SD Range |
|---------------|-------|-------|---------------------|--------|-----------|----------|
| Q001 | Serum | 1 | 1.ChemTrack Level 1 | 115 | | 4 |
| Q001 | Serum | 2 | 2.ChemTrack Level 3 | 245 | | 4 |
| Q002 | Serum | 1 | 1.ChemTrack Level 1 | | ? | 4 |
| Q002 | Serum | 2 | 2.ChemTrack Level 3 | | ? | 4 |

- Select **Edit (F1)**.
- Select the test to edit or delete from the “Test Name” drop-down list.
- Select the Result or Data Flag to edit. To delete a test(s), enter a “d” flag in Data Flag.
- To edit a comment, select **Index Comment (F3)** or **Test Comment (F4)**.
- Select **Confirm (F1)** to program the QC edits or deletions.

6.14 Save Data to External Media

Save analysis data to external media for a backup of data, or to transfer the data to another computer. Data is saved to an “AU Data” folder. The data files are identified by the index.

For example: 20100405_0732_000.csv is data saved from the index April 5, 2010 at 07:32. If data is saved from the same index again, the file would be 20100405_0732_001.csv.

Sample data, repeat sample data, reagent blank, calibration and QC data can be saved to external media.

Save Samples (routine, emergency, and STAT), Repeat Samples, Reagent Blank, Calibration, and QC Data

- 1 Select **Menu List > System > External Data Management > External Data Management**.

Figure 6.20

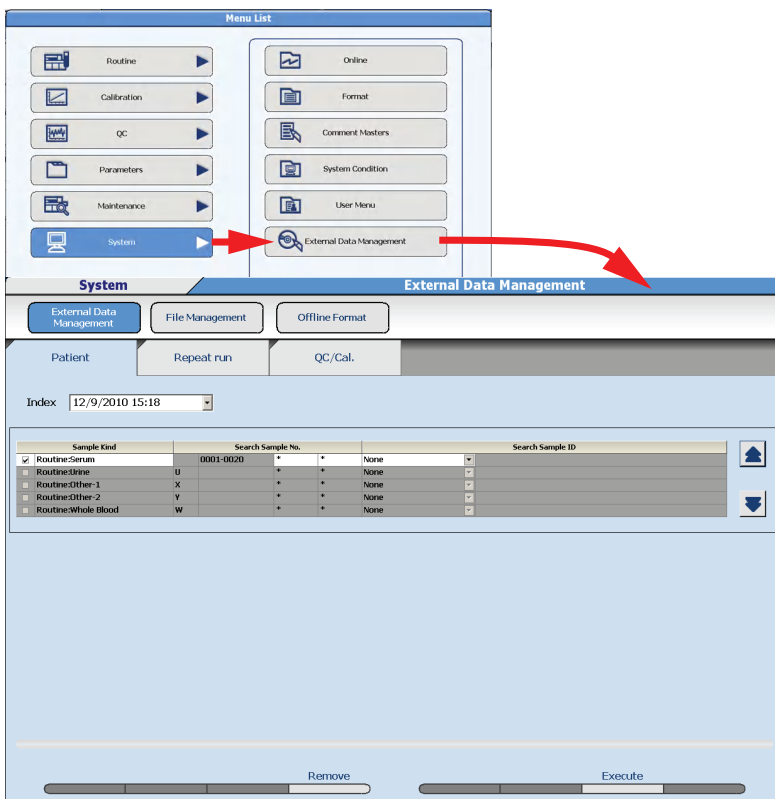

- 2 Select **Patient** to save routine, emergency, and STAT samples, **Repeat Run** to save repeat samples, or **QC/Cal.** to save reagent blank, calibration, or QC samples.
- 3 Select the index from the “Index” drop-down list.

- 4 Check the Sample Kind to save. Enter the Search Sample No. and Search Sample ID number to save, or leave the “*” to save all data. Use the up/down arrow buttons to change to Emergency or STAT samples.
- 5 Select **Execute (F7)**. Verify the Total Output Samples and <Number of Output Samples> information.

Figure 6.21

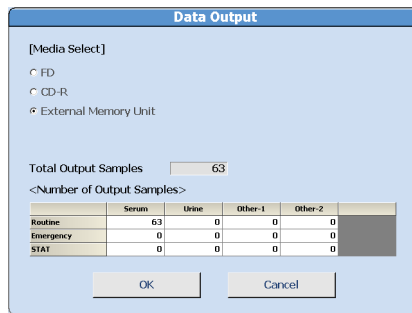

- 6 Select **FD**, **CD-R**, or **External Memory Unit**.
TIP If FD is selected, a check box is available to format the FD.
- 7 Select **OK**. The Data Output window opens and displays a confirmation message.
- 8 Select **OK**. A Data Output window displays a comment and the save progress.
TIP A confirmation or warning message appears depending on the save progress.

A comment indicating the data save has been successfully completed appears on the Data Output window.
- 9 Select **OK**. Remove the media.

6.15 Save or Load Parameters

The system can save or load parameters to a backup folder on the hard drive or external media.

Beckman Coulter recommends saving parameters when programming changes are made, or following laboratory Standard Operating Procedures.

6.15.1 Save or Load Parameter Files

- 1 Select **Menu List > System > External Data Management > File Management.**

Figure 6.22

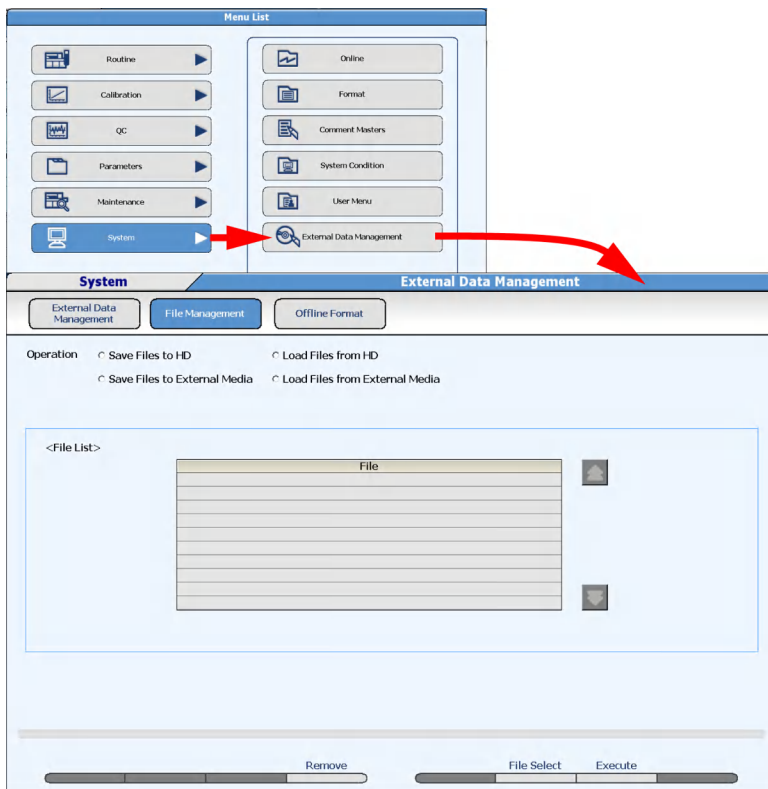

-
- 2** For Operation, select **Save Files to HD**, **Load Files from HD**, **Save Files to External Media**, or **Load Files from External Media**.

TIP Saving or loading files to “HD” is a backup folder on the hard drive.

-
- 3** Select **File Select (F6)**. The File Select window opens.

Figure 6.23

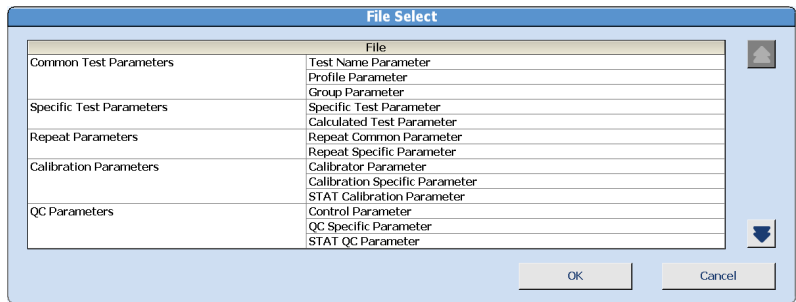

-
- 4** Select the file(s) to be saved or loaded. Select a menu from the left column to include all the submenus, or select only the submenu from the right column.

-
- 5** Select **OK**. The selected files are displayed.

6 Select **Execute (F7)**.

If saving or loading using external media, select **FD, CD-R, or External Memory Unit**, then **OK**. “Insert Disk. Start?” or “Connect External Memory Unit. Start?” displays. Select **OK**.

The Execute window opens when the operation is complete.

Figure 6.24

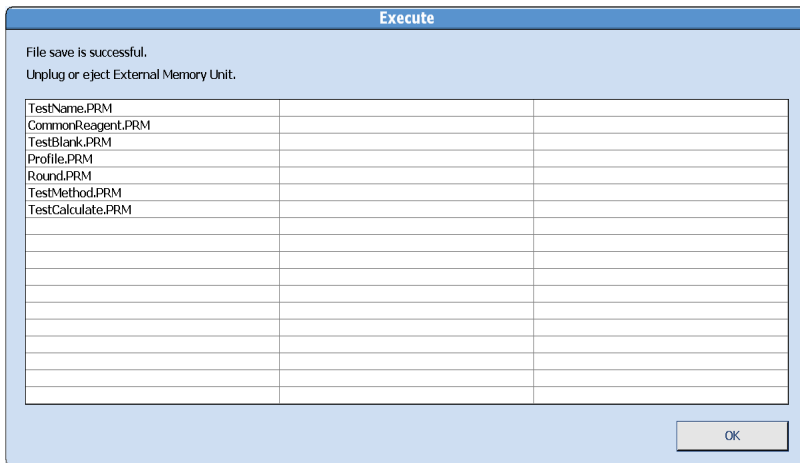

 **CAUTION**

If you save the parameters to FD, CD-R, or External Memory Unit, the existing parameters are overwritten without warning.

TIP If FD is selected, a check box is available to format the FD. When the format is complete, select **Execute (F7)** to save the files.

7 Select **OK**. Remove the external media.

6.16 Disable a Test

Specific tests can be selected to stop analysis (disable) even when the test has a requisition. Examples of when it may be useful to disable a test are if the calibration fails for that test, or QC fails and samples are in process.

TIP A test can be disabled or enabled during a Measure mode. Analysis of the test(s) will stop or re-start after selection in **Disable (F7)**.

Tests are not disabled for reagent blank, calibration, and QC samples.

Tests that are disabled display and print with a “/” error flag, indicating the test was requisitioned but not performed.

Selections in the Disable window are effective until a new index is made, or an End Process is performed.

1 Select **Home > Start Condition**.

Figure 6.25

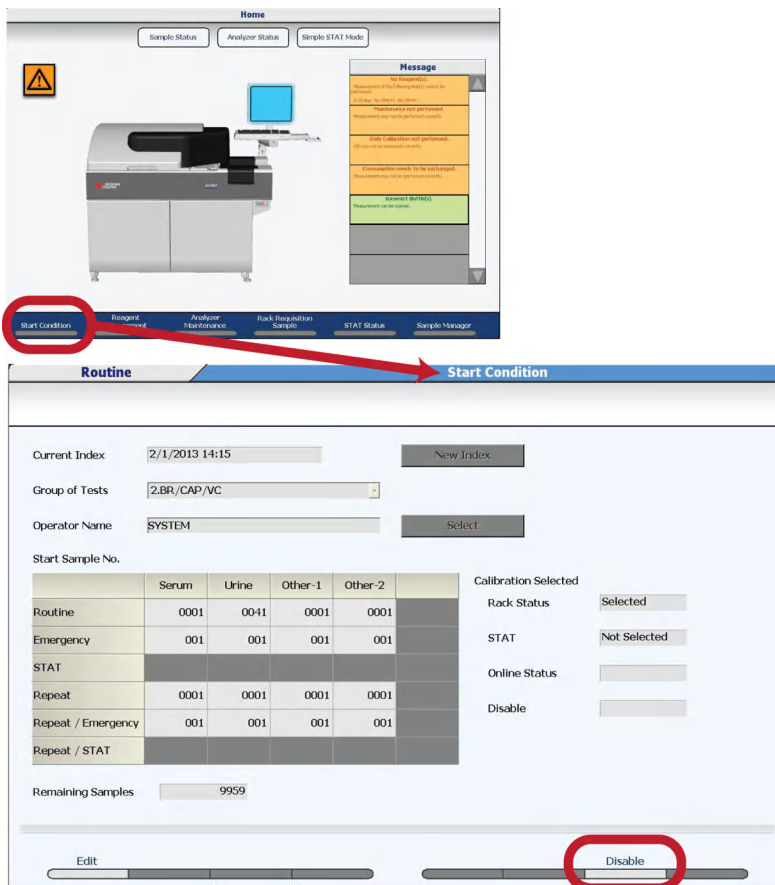

-
- 2** Select **Disable (F7)**. The Disable window opens. A list of tests to disable is displayed.

Figure 6.26

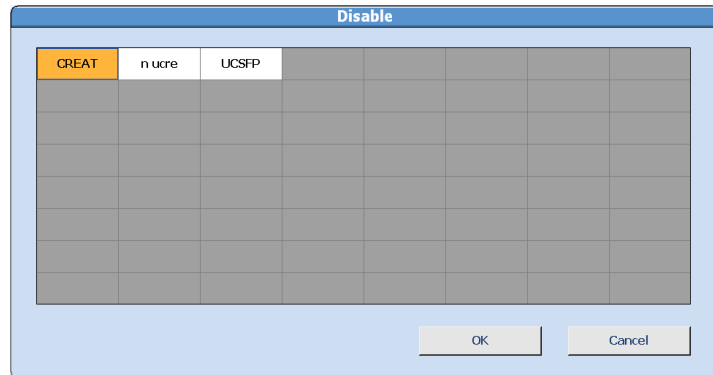

-
- 3** Select the test(s) to be disabled. Tests that are disabled are highlighted in orange.
-
- 4** Select **OK**. Test selections are registered, and the display returns to **Start Condition**.
-

This chapter describes the analyzer modes, how to perform a system shutdown (**End Process**), and how to stop analysis or emergency stop the system.

7.1 Analyzer Modes

7.2 Bypass Warm Up to Standby Mode

7.3 System Shutdown (End Process)

7.4 Transfer the Analyzer to Stop Mode

7.4.1 Stop Analysis

7.4.2 Return to Standby Mode

7.5 Perform an Emergency Stop

7.5.1 Return to Standby Mode

7.1 Analyzer Modes

Figure 7.1



1. Mode Display Area

The system modes that can display in the “Mode Display Area” are shown below.

| Mode | Contents |
|----------------|---|
| <i>Initial</i> | Displays after the green ON button is pressed. The software loads and the hardware initializes. |
| <i>Warm up</i> | After the system initializes, the mode changes to <i>Warm Up</i> for approximately 20 minutes to allow the lamp to warm up and stabilize. |

| Mode | Contents |
|------------------|---|
| <i>Standby</i> | When the system is ready to perform sample analysis, the operation mode changes to <i>Standby</i> . Analysis can be started. |
| <i>Measure 1</i> | Measure 1 occurs when the Start button is selected. Racks are present on the rack supply unit, and are moving to the sample aspiration position. |
| <i>Measure 2</i> | Measure 2 occurs when there are no more racks on the rack supply unit. To start additional racks, select the Start button. |
| <i>Stop</i> | <i>Stop</i> mode occurs when there is a system error, or when the operator selects the Stop/Standby button. The analyzer can not be started from <i>Stop</i> mode. To return to <i>Standby</i> mode, select the Stop/Standby button. The mode displays as <i>Reset</i> while the hardware is initializing, then it goes to <i>Standby</i> . All tests in progress must be repeated. |
| <i>Pause</i> | <i>Pause</i> mode occurs when there is a system error, or when the operator selects the Pause button. Analysis can be re-started from <i>Pause</i> by selecting Start button. All tests in progress will be completed. |



If a Stop or Emergency Stop occurs, sample can remain in the sample probe, and reagents can remain in the cuvettes. Perform a W1 to clean the sample probe and cuvettes.

For details on how to perform a W1, refer to 8.8.11 Perform a W1 in the *AU480 User's Guide*, chapter 8.

7.2 Bypass Warm Up to Standby Mode

The system requires a 20-minute lamp warm up before analysis can be started if an **End Process** was performed. If a power failure or an emergency stop (EM STOP button on analyzer) was performed, the mode stays in *Warm Up* for 1.5 hours. Analysis cannot be started from *Warm Up* mode.

1 Select **Home > Analyzer Maintenance**.

2 Select **Stand By (F4)**.

The Stand By window opens with the message “Switch to Standby mode? The system may not be thermally equilibrated if Warm up is bypassed.”

3 Select **OK**. The mode changes to *Standby*.

7.3 System Shutdown (End Process)

An **End Process** turns off the analyzer lamp and the computer. The refrigerator, incubator, and STAT table compartment temperatures are maintained. The ISE unit performs an automatic prime with Mid Standard every hour to keep the electrodes conditioned.

An **End Process** can be initiated after a W2 and/or Photocal is started. In this case, the W2 and/or Photocal completes, then the system shuts down. Refer to 8.4.2 Perform a W2 to start the W2 and/or Photocal in the *AU480 User's Guide*, chapter 8.

1 Select **Home**.

2 Select **End** from the main button bar. The End window opens.

Figure 7.2

The screenshot shows a software dialog box titled "End". At the top, it asks "Power Off?" with two buttons: "Yes" and "No". Below this is a section titled "Set up Next on-time." which contains several options: "Auto Start up" with radio buttons for "Yes" and "No"; "with Auto Preparation" with radio buttons for "Yes" and "No"; "Photocal" label; "Date" dropdown menu showing "12/17/2010" and "Friday" text; and "Time" dropdown menu showing "05" and ": 00" dropdown. A "Setting" button is located at the bottom right of the "Set up Next on-time." section.

3 Verify the next auto on time. To set an auto on time, select **Setting**. Select **Yes** at Auto Start Up. Select the Date and Time for the system to turn on from the "Date" and "Time" drop-down lists. To turn off the auto on time, select **No** at Auto Start Up. Select **Confirm**.

4 Select **Yes**. The system shuts down.

5 Follow laboratory Standard Operating Procedures for turning off the DI water supply.



Follow laboratory Standard Operating Procedures for turning off the DI water supply. Special considerations include weekends, holidays, and automatic maintenance procedures that may be scheduled.

TIP The system can be programmed for an Auto On Time and Auto Preparation for each day of the week. Refer to [6.5 Program the Automatic Startup Function](#) in chapter 6, in this guide.

Auto Preparation must be programmed in the System Maintenance menu by Beckman Coulter Technical Services at installation. Auto Preparation can be programmed for the weekly Photocal.

7.4 Transfer the Analyzer to Stop Mode

To immediately stop the analysis operation perform a system Stop.



- When the system is transferred to **Stop** mode, any data that is not complete is lost and must be repeated.
- Reagents remain in the cuvettes after performing a Stop. Perform a W1 to remove reagents before performing an End Process or resuming analysis. Refer to 8.8.11 Perform a W1 in the *AU480 User's Guide*, chapter 8.

7.4.1 Stop Analysis

- 1 Select **Stop/Standby** during analysis operation. The Stop window opens with the message “Transfer to Stop Mode?”.

Figure 7.3

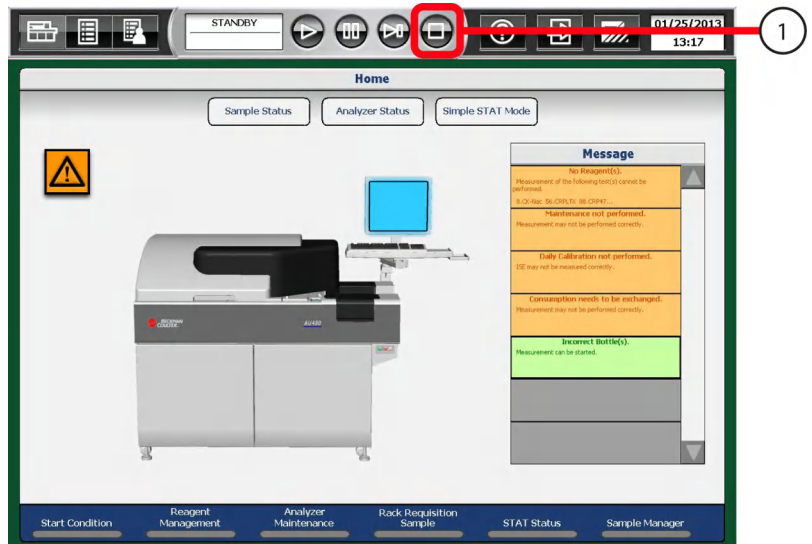

1. Stop/Standby

Analyzer Modes

7.4 Transfer the Analyzer to Stop Mode

-
- 2 Select **OK**. All analysis operation stops, and the system goes to *Stop* mode.
-
- 3 Remove racks from the rack transport belts.
-

7.4.2 Return to *Standby* Mode

-
- 1 Select **Stop/Standby** in *Stop* mode. The Warmup/Standby window opens with the message “Reset Analyzer and Transfer to Standby mode?”.
-
- 2 Select **OK**. The system reset operation is performed. After the reset operation completes, the system goes to *Standby* mode or *Warm up* mode.
-
- 3 Perform a W1.

Refer to 8.8.11 Perform a W1 in the *AU480 User’s Guide*, chapter 8.

7.5 Perform an Emergency Stop

Select the **EM STOP** button (red button on the front, right side of the analyzer) to immediately turn off power to the analyzer and ISE unit. All analysis immediately stops.



- **When the EM STOP button is pressed, any data that is not complete is lost and must be repeated.**
- **Reagents remain in the cuvettes after performing an Emergency Stop. Perform a W1 to remove reagents before performing an End Process or resuming analysis. For details on performing the W1, refer to 8.8.11 Perform a W1 in the AU480 User's Guide, chapter 8.**

1 Press the EM STOP button. All power to the analyzer and ISE unit turns off immediately. The computer remains On. To turn off the computer, press **(Ctrl) + (ALT) + (Delete)**. A Windows Security window opens. Select the **Shutdown** button.

2 Remove all racks from the rack transport belts.

7.5.1 Return to *Standby Mode*

1 Press the RESET button.

2 Press the ON button. (The lamp turns on and the software loads.) A window appears to confirm the retrieval of the database.

3 Select **OK**.

4 In the New Index window, select **Current Index** to continue analysis in the current index.

5 The system stays in *Warm Up* mode for 1.5 hours. After the required 20-minute lamp warm up time, wait until the temperature of the cuvette wheel is 37 degrees, then select **Home > Analyzer Maintenance > Stand By (F4)** to return to *Standby*.

6 Perform a W1.

Refer to 8.8.11 Perform a W1 in the *AU480 User's Guide*, chapter 8.

For detailed information on troubleshooting the system, including reagents, calibrators, quality control, samples, mechanical problems, and data processor problems, refer to CHAPTER 11, Troubleshooting in the *AU480 User's Guide*.

[8.1 Using the Online Help](#)

[8.2 Review Alarms and Corrective Actions](#)

[8.3 Review Error Flags](#)

8.1 Using the Online Help

The **Help** button displays a menu to access user documentation and a maintenance video directory. The **Alarm List** button provides alarm descriptions and corrective actions.

TIP To stop the audible alarm, select **Alarm Clear**. Select **Alarm Clear** a second time to clear the alarm message from the screen.

Figure 8.1

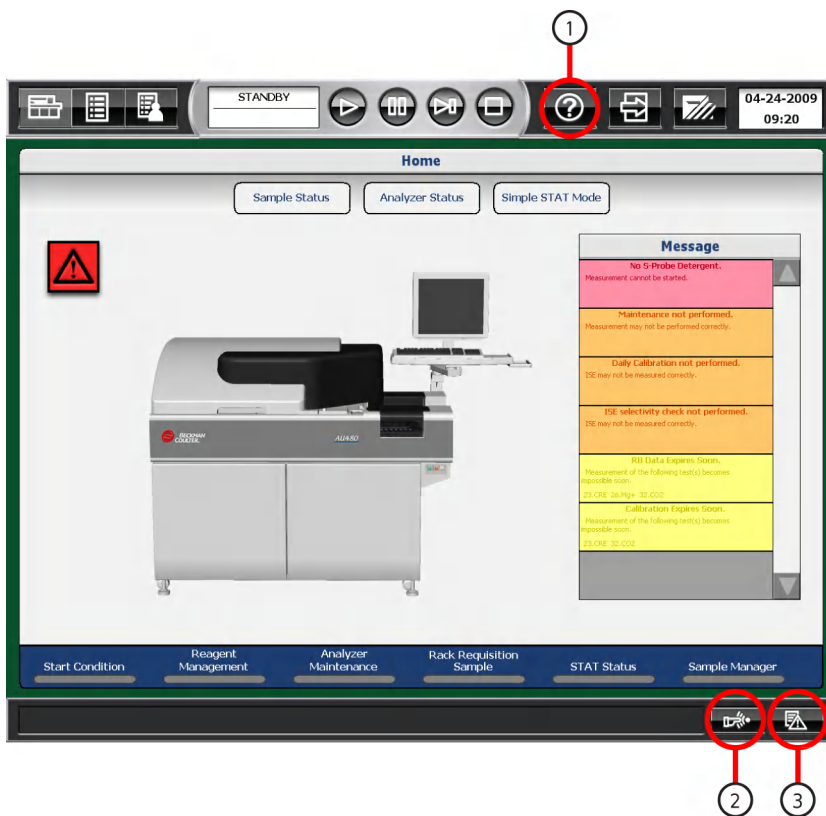

1. Help
2. Alarm Clear
3. Alarm List

Four types of help are shown in the following table.

| Type of Help | Displayed Description |
|--------------------|--|
| Help | Displays the PDF version of the <i>AU480 User's Guide</i> and Maintenance videos. Select the Help button. The Help button can only be accessed in <i>Warm Up</i> , <i>Standby</i> or <i>Stop</i> . |
| Alarm List | Displays alarm descriptions and corrective actions. Select Alarm List to display the Alarm List window. Select the Help button on the Alarm List window. |
| Input Help | Displays the range of allowable input values. Move the cursor over the input area to display the pop-up Input Help. |
| Button Help | To determine the function of a button, move the mouse pointer over the button, and a pop-up message indicates the function of the button. |

The *AU480 User's Guide* and this *Quick Response Guide* do not describe alarms or corrective actions. Select **Alarm List** for alarm help.

8.2 Review Alarms and Corrective Actions

Check for Alarms

Review the Alarm List. The **Alarm List** can be accessed from any menu.

Select **Alarm List** ( on the lower, right corner of the screen).

Figure 8.2



| No. | Date | Level | Alarm No. | Alarm |
|-----|---------------------|-------|-----------|--|
| 53 | 2009/12/16 11:24:11 | 3 | 5011 | SYSTEM END |
| 54 | 2009/12/16 11:18:18 | 2 | 6025 | NO CALIBRATION DATA (s1.7o , Urine , 1, OUTER, 2) |
| 55 | 2009/12/16 11:18:18 | 2 | 6025 | NO CALIBRATION DATA (UN120I, Serum , 1, INNER, 2) |
| 56 | 2009/12/16 11:18:18 | 2 | 6025 | NO CALIBRATION DATA (s1.7I , Urine , 1, INNER, 2) |
| 57 | 2009/12/16 11:17:16 | 2 | 6025 | NO CALIBRATION DATA (s1.7o , Urine , 1, OUTER, 2) |
| 58 | 2009/12/16 11:17:16 | 2 | 6025 | NO CALIBRATION DATA (UN120I, Serum , 1, INNER, 2) |
| 59 | 2009/12/16 11:17:16 | 2 | 6025 | NO CALIBRATION DATA (s1.7I , Urine , 1, INNER, 2) |
| 60 | 2009/12/16 11:06:39 | 3 | 5031 | INDEX UPDATED (2009/12/16 11:06) |
| 61 | 2009/12/16 11:06:37 | 3 | 5004 | STANDBY |
| 62 | 2009/12/16 11:06:33 | 3 | 5003 | WARM UP |
| 63 | 2009/12/16 11:06:23 | 3 | 5090 | LOGIN (AUS800 , 1) |
| 64 | 2009/12/16 11:06:18 | 1 | 9001 | PROGRAM INF ([AniComm/GetSystemConstruct,4], MAC address : Loop Back Address.(Sampler) |
| 65 | 2009/12/16 11:06:17 | 3 | 5002 | INITIALIZE |
| 66 | 2009/12/16 11:06:17 | 3 | 5051 | POWER ON |
| 67 | 2009/12/16 11:04:47 | 3 | 5011 | SYSTEM END |
| 68 | 2009/12/16 10:39:52 | 3 | 5031 | INDEX UPDATED (2009/12/16 10:33) |
| 69 | 2009/12/16 10:33:55 | 3 | 5004 | STANDBY |
| 70 | 2009/12/16 10:33:52 | 3 | 5003 | WARM UP |
| 71 | 2009/12/16 10:33:42 | 3 | 5090 | LOGIN (AUS800 , 1) |
| 72 | 2009/12/16 10:33:41 | 1 | 9001 | PROGRAM INF ([AniComm/GetSystemConstruct,4], MAC address : Loop Back Address.(Sampler) |

“Level” shows the alarm level by numbers and colors.

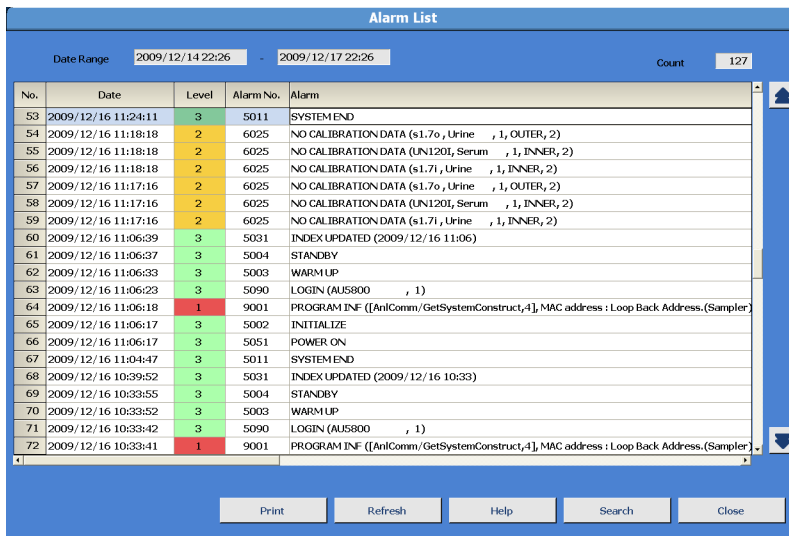
| Level | Background color | Extent |
|---------|------------------|--|
| Level 1 | Red | An abnormality preventing the analyzer from starting exists. |
| Level 2 | Yellow | An abnormality influencing the data exists. |
| Level 3 | Green | There is no system abnormality. The operation log is displayed. |

The Count at the right top of the window indicates the number of alarms within “Date Range.” Nine hundred ninety-nine (999) cases can be stored and displayed using the scroll bar.

From this window, the following options can be performed:

- **Print:** Prints a list of all alarms.
- **Refresh:** Returns the display to the most recent alarms.
- **Help:** Display a description of the alarm and corrective actions.
- **Search:** Search for alarms by date, alarm number, and/or alarm level.
- **Close:** Select **Close** to close the Help window.

8.3 Review Error Flags

Check for Error flags

If a problem occurs during analysis, the system appends a flag to the analysis results. Check all generated results carefully for error flags and take the appropriate action.

For details on error flags, refer to CHAPTER 9, Error Flags. in the *AU480 User's Guide*.

It is important that the operator reviews each flag as it is generated and identifies the root cause. No result should be reported with an unresolved, unexpected flag.

If a test generates an error flag, the test name and error flag appear in red on **Sample Status**.

The following table summarizes the error flags in order of priority:

| Flag | Definition |
|------|---|
| d | QC result is excluded by user |
| e | Data edited by user |
| (| Shortage of cleaning solution for contamination parameters |
| Wa | Result has been analyzed with an erroneous cuvette |
| R | Insufficient reagent detected |
| # | Insufficient sample detected |
| % | Clot detected |
| ? | Unable to calculate a result |
| n | LIH test not performed |
| l | Result may be affected by lipemia |
| i | Result may be affected by icterus |
| h | Result may be affected by hemolysis |
| Y | Reagent blank OD exceeds the high limit set at the last photometric read point |
| U | Reagent blank OD exceeds the lower limit set at the last photometric read point |
| y | Reagent blank/routine OD at first photometric point high |
| u | Reagent blank/routine OD at first photometric point low |
| @ | OD is higher than 3.0 |
| \$ | Not enough data to determine linearity of reaction |
| D | OD of reaction is higher than the maximum OD range |
| B | OD of reaction is lower than the minimum OD range |
| * | Linearity error in rate method |
| & | Prozone test data is abnormal |
| Z | Prozone error |
| E | Overreaction in a rate assay detected |
| Fx | Result (OD) is higher than the dynamic range |

| Flag | Definition |
|-------------|--|
| Gx | Result (OD) is lower than the dynamic range |
| ! | Unable to calculate concentration |
|) | Reagent lot number used for sample analysis is different from the lot number used for RB/Calibration |
| a | Reagent expired |
| ba | No calibration data or expired |
| bh | The latest calibration/RB has not been used |
| bn | Mastercurve used |
| bz | Calibration curve for Prozone data used |
| F | Result is higher than the dynamic range |
| G | Result is lower than the dynamic range |
| ph | Result is higher than the upper panic value |
| pl | Result is lower than the low panic value |
| T | Abnormality found in inter-chemistry check |
| P | Positive |
| N | Negative |
| H | Result is higher than reference range |
| L | Result is lower than reference range |
| J | Result is higher than the repeat decision range |
| K | Result is lower than the repeat decision range |
| fh | Result is higher than the repeat run reflex range |
| fl | Result is lower than the repeat run reflex range |
| Va | Deviation of multiple measurements check is out of range |
| xQ | Multi-rule QC has detected failure on one control |
| 1Q | QC data exceeds the range entered in Single Check Level field |
| 2Q | QC data exceeds 1_{3s} control range |
| 3Q | QC data exceeds 2_{2s} control range |
| 4Q | QC data exceeds R_{4s} control range |

| Flag | Definition |
|------|--|
| 5Q | QC data exceeds 4_{1s} control range |
| 6Q | A preset number of consecutive QC results fall on one side of the mean |
| 7Q | Consecutive QC results show steadily increasing or decreasing values |
| S | Sample repeated and original results replaced by repeat result |
| / | Test pending or not analyzed |
| r | Result has been transferred to LIS (HOST Computer) through on-line communication |
| c | Result corrected by user |

A

Alarms
Alarm shots, 6-3
Analyzer status, 3-8

B

Buttons, 2-12, 2-15

C

Calibration
Advanced calibration, 3-18
Perform calibration, 3-26
Calibrator
Program calibrator concentrations, 6-16

D

Data management
Save data, 6-47
Demographics, 6-5

E

Emergency samples, 4-9, 4-17, 7-3
Emergency stop, 7-9
End process, 2-9, 7-5

G

Group
Group of tests, 6-4, 6-11

H

Hardware, 2-2
Host computer, 4-14

I

ISE
ISE daily maintenance, 3-10
ISE reagents, 3-10
ISE startup, 3-10

L

Laboratory automation system, 3-26

M

Main button bar, 2-9
Maintenance
Daily maintenance, 3-7, 3-12
Measure modes
Measure 1, 7-3
Measure 2, 2-20, 7-3

O

Online
Online help, 2-18, 2-20, 8-2

P

Priority
Priority STAT, 4-18
Profile
Create a profile, 6-11

Program

- Program a new test, [6-3](#)
- Program a user menu, [6-23](#)
- Program the automatic startup function, [6-20](#)

Q

Quality control

- Perform QC, [3-35](#)

R

Racks

- Red rack, [4-11](#)
- White rack, [4-11](#)

Reagent transfer unit, [2-2](#), [2-3](#)

Reagents

- Reagent check, [3-14](#)
- Reagent ID, [6-36](#)
- Reagent management, [3-26](#)
- Reagent on-board stability, [3-17](#), [3-18](#), [3-20](#)
- Reagent position, [3-14](#)
- Reagent status, [3-13-3-16](#)

Requisition

- Batch requisition, [4-13](#)
- Download requisitions, [4-14](#)
- Manual requisition, [4-10](#)
- Requisition for emergency samples, [4-9](#)
- Requisition for routine samples, [4-9](#)

S

Samples

- Sample status, [5-4](#)

Software

- Software buttons, [1-5](#)
- Software chart, [2-4](#)
- Software description, [2-8](#)
- Software paths, [1-3](#)
- Software screens, [1-5](#)

Start

- Daily startup, [3-1](#)

Start analysis, [3-43](#)

Startup, [3-2](#)

STAT

- STAT sample, [4-18](#)
- STAT table, [3-30](#)

T

Typographical conventions, [1-2](#)

U

Units, [1-6](#)

W

Warnings

- Warnings and cautions, [1-2](#)