

Operating Manual

Translation of the original operating manual

KBF P / KBF P-UL (E6)

Constant climate chambers with ICH compliant illumination with program control and adjustable light cassettes

Model	Model version	Art. No.
KBF P 240	KBFP240-230V	9020-0328, 9120-0328
KBF P 240-UL	KBFP240UL-240V	9020-0329, 9120-0329
KBF P 720	KBFP720-230V	9020-0330, 9120-0330
KBF P 720-UL	KBFP720UL-240V	9020-0331, 9120-0331

KBF LQC / KBF LQC-UL (E6)

Constant climate chambers with ICH compliant illumination and light dose detection with program control and adjustable light cassettes

Model	Model version	Art. No.
KBF LQC 240	KBFLQC240-230V	9020-0332, 9120-0332
KBF LQC 240-UL	KBFLQC240UL-240V	9020-0333, 9120-0333
KBF LQC 720	KBFLQC720-230V	9020-0334, 9120-0334
KBF LQC 720-UL	KBFLQC720UL-240V	9020-0335, 9120-0335

KBWF (E6)

Growth chambers with light and humidity with program control and adjustable light cassettes

Model	Model version	Art. No.
KBWF 240	KBWF240-230V	9020-0336, 9120-0336
KBWF 720	KBWF720-230V	9020-0337, 9120-0337

Content

1. SAFETY	7
1.1 Personnel Qualification	7
1.2 Operating manual	7
1.3 Legal considerations	7
1.4 Structure of the safety instructions	8
1.4.1 Signal word panel	8
1.4.2 Safety alert symbol	8
1.4.3 Pictograms	9
1.4.4 Word message panel structure	10
1.5 Localization / position of safety labels on the chamber	10
1.6 Type plate	12
1.7 General safety instructions on installing and operating the chambers	13
1.8 Intended use	15
1.9 Foreseeable Misuse	16
1.10 Residual Risks	17
1.11 Operating instructions	18
1.12 Measures to prevent accidents	19
1.13 Resistance of the humidity sensor against harmful substances	20
2. CHAMBER DESCRIPTION AND OVERVIEW	21
2.1 Chamber description	21
2.1.1 KBF P / KBF P-UL and KBF LQC / KBF LQC-UL	21
2.1.2 KBWF	21
2.1.3 General	22
2.2 Chamber overview	23
2.3 Instrument panel	23
2.4 Lateral control panels	24
2.5 Rear view with water connections	25
3. COMPLETENESS OF DELIVERY, TRANSPORTATION, STORAGE, AND INSTALLATION	26
3.1 Unpacking, and checking equipment and completeness of delivery	26
3.2 Guidelines for safe lifting and transportation	27
3.3 Storage	27
3.4 Location of installation and ambient conditions	28
4. INSTALLATION AND CONNECTIONS	30
4.1 Spacer for wall distance	30
4.2 Wastewater connection	30
4.3 Freshwater supply	31
4.3.1 Automatic fresh water supply via water pipe	31
4.3.2 Manual fresh water supply via external freshwater can (option)	32
4.3.3 Connection kit for connecting the chamber to the water main	32
4.3.4 Safety kit: Hose burst protection device with reflux protection device (available via BINDER INDIVIDUAL customized solutions)	33
4.4 Installation and connection of the light cassettes	35
4.5 Connecting the light sensors – KBF LQC / KBF LQC-UL	36
4.6 Electrical connection	37
4.7 Connection of the voltage changer (option for KBF P 240 / KBF LQC 240)	38
5. FUNCTIONAL OVERVIEW OF THE MB2 CHAMBER CONTROLLER	40
5.1 Operating functions in normal display	42
5.2 Display views: Normal display, program display, chart-recorder display	43
5.3 Controller icons overview	44
5.4 Operating modes	46

5.5	Controller menu structure.....	47
5.5.1	Main menu.....	48
5.5.2	“Settings” submenu.....	49
5.5.3	“Service” submenu.....	49
5.6	Principle of controller entries.....	50
5.7	Performance during and after power failures.....	50
5.8	Performance when opening the door.....	51
6.	START UP.....	51
6.1	Turning on the chamber.....	51
6.2	Controller settings upon start up.....	52
6.3	Turning on/off humidity control.....	53
7.	FUNCTION OF LIGHT MEASUREMENT, AND INTEGRATION: LIGHT QUANTUM CONTROL – KBF LQC / KBF LQC-UL.....	54
7.1	Display of the instantaneous and the integrated values.....	54
7.2	Measurement of illumination intensity and temporal integration.....	54
8.	SET-POINT ENTRY IN “FIXED VALUE” OPERATING MODE.....	56
8.1	Set-point entry through the “Setpoints” menu.....	57
8.2	Direct setpoint entry via Normal display.....	58
8.3	Automatic correction of the actual value when turning on or off the illumination.....	58
8.4	Light commutation and special controller functions via operation lines.....	59
9.	TIMER PROGRAM: STOPWATCH FUNCTION.....	60
9.1	Starting a timer program.....	60
9.1.1	Performance during program delay time.....	61
9.2	Stopping a running timer program.....	61
9.2.1	Pausing a running timer program.....	61
9.2.2	Cancelling a running timer program.....	61
9.3	Performance after the end of the program.....	61
10.	TIME PROGRAMS.....	62
10.1	Starting an existing time program.....	62
10.1.1	Performance during program delay time.....	63
10.2	Stopping a running time program.....	63
10.2.1	Pausing a running time program.....	63
10.2.2	Cancelling a running time program.....	63
10.3	Performance after the end of the program.....	63
10.4	Creating a new time program.....	64
10.5	Program editor: program management.....	64
10.5.1	Deleting a time program.....	65
10.6	Section editor: section management.....	66
10.6.1	Add a new program section.....	67
10.6.2	Copy and insert or replace a program section.....	67
10.6.3	Deleting a program section.....	68
10.7	Value entry for a program section.....	69
10.7.1	Section duration.....	70
10.7.2	Set-point ramp and set-point step.....	70
10.7.3	Light commutation and special controller functions via operation lines.....	72
10.7.4	Setpoint entry.....	73
10.7.5	Tolerance ranges.....	74
10.7.6	Repeating one or several sections within a time program.....	74
10.7.7	Saving the time program.....	75
11.	WEEK PROGRAMS.....	76
11.1	Starting an existing week program.....	76
11.2	Cancelling a running week program.....	76
11.3	Creating a new week program.....	77

11.4	Program editor: program management.....	78
11.4.1	Deleting a week program.....	79
11.5	Section editor: Section management.....	80
11.5.1	Add a new program section.....	81
11.5.2	Copy and insert or replace a program section.....	81
11.5.3	Deleting a program section.....	82
11.6	Value entry for a program section.....	82
11.6.1	Set-point ramp and set-point step modes.....	82
11.6.2	Weekday.....	83
11.6.3	Start time.....	83
11.6.4	Setpoint entry.....	84
11.6.5	Light commutation and special controller functions via operation lines.....	84
12.	NOTIFICATION AND ALARM FUNCTIONS.....	85
12.1	Notification and alarm messages overview.....	85
12.1.1	Notifications.....	85
12.1.2	Messages when reaching a dose target value – KBF LQC / KBF LQC-UL.....	86
12.1.3	Alarm messages.....	87
12.1.4	Messages concerning the humidity system.....	87
12.2	State of alarm.....	88
12.3	Resetting an alarm, list of active alarms.....	89
12.4	Tolerance range settings.....	89
12.5	Activating / deactivating the audible alarm (alarm buzzer).....	90
13.	TEMPERATURE SAFETY DEVICES.....	91
13.1	Over temperature protective device (class 1).....	91
13.2	Overtemperature safety controller class 3.1.....	91
13.2.1	Safety controller modes.....	91
13.2.2	Setting the safety controller.....	92
13.2.3	Message and measures in the state of alarm.....	93
13.2.4	Function check.....	93
13.3	Temperature safety device class 3.3 (option).....	93
13.3.1	Temperature safety device class 3.1.....	94
13.3.2	Temperature safety device class 3.2.....	95
14.	USER MANAGEMENT.....	96
14.1	Authorization levels and password protection.....	96
14.2	Log in.....	99
14.3	Log out.....	100
14.4	User change.....	100
14.5	Password assignment and password change.....	101
14.5.1	Password change.....	101
14.5.2	Deleting the password for an individual authorization level.....	103
14.5.3	New password assignment for “service” or “admin” authorization level when the password function was deactivated.....	104
14.6	Activation code.....	105
15.	GENERAL CONTROLLER SETTINGS.....	106
15.1	Selecting the controller’s menu language.....	106
15.2	Setting date and time.....	106
15.3	Selecting the temperature unit.....	108
15.4	Display configuration.....	108
15.4.1	Adapting the display parameters.....	108
15.4.2	Touchscreen calibration.....	109
15.5	Network and communication.....	110
15.5.1	Serial interfaces.....	110
15.5.2	Ethernet.....	111
15.5.3	Web server.....	112
15.5.4	E-Mail.....	113
15.6	USB menu: Data transfer via USB interface.....	114

16. GENERAL INFORMATION	115
16.1 Service contact page.....	115
16.2 Current operating parameters	115
16.3 Event list.....	116
16.4 Technical chamber information.....	116
16.5 Self-test function	117
17. CHART RECORDER DISPLAY	119
17.1 Views.....	119
17.1.1 Show and hide legend.....	119
17.1.2 Switch between legend pages.....	120
17.1.3 Show and hide specific indications.....	120
17.1.4 History display	121
17.2 Setting the parameters.....	123
18. HUMIDIFICATION / DEHUMIDIFICATION SYSTEM	125
18.1 Function of the humidifying and dehumidifying system	127
19. DEFROSTING AT REFRIGERATING OPERATION	128
20. ILLUMINATION SYSTEM	129
20.1 ICH compliant illumination according to CPMP/ICH/279/95 (Q1B) – KBF P / KBF P-UL, KBF LQC / KBF LQC-UL	129
20.2 Illumination for optimal plant growth – KBWF	130
20.3 Adjustable light cassettes.....	130
20.4 Illumination control	132
20.5 Characteristic features of the light sensors – KBF LQC / KBF LQC-UL	133
20.5.1 LUX sensor	133
20.5.2 UVA sensor	133
20.5.3 Spectral range	133
20.5.4 Spatial sensitivity.....	134
21. OPTIONS.....	136
21.1 APT-COM™ 4 Multi Management Software (option).....	136
21.2 RS485 interface (option)	136
21.3 Data logger kits (option).....	136
21.4 Analog outputs for temperature and humidity (option).....	137
21.5 Zero-voltage relay alarm outputs for temperature and humidity (option).....	137
21.6 Water protected internal socket (option).....	138
21.7 Additional flexible Pt 100 temperature sensor (available via BINDER INDIVIDUAL customized solutions).....	138
21.8 Object temperature display with flexible Pt 100 temperature sensor (option)	139
21.9 External freshwater and wastewater cans (option).....	139
21.9.1 Mounting the freshwater can	140
21.9.2 Mounting the wastewater can.....	141
21.9.3 Mounting with wastewater recycling.....	142
21.10 BINDER Pure Aqua Service (option)	143
22. CLEANING AND DECONTAMINATION	144
22.1 Cleaning	144
22.2 Decontamination / chemical disinfection.....	145
23. MAINTENANCE AND SERVICE, TROUBLESHOOTING, REPAIR, TESTING. 147	
23.1 General information, personnel qualification.....	147
23.2 Maintenance intervals, service.....	147
23.3 Replacement of the fluorescent tubes	148
23.4 Calibrating the light sensors and adjusting the controller display – KBF LQC / KBF LQC-UL	149
23.5 Simple troubleshooting.....	149
23.6 Sending the chamber back to BINDER GmbH	153

24. DISPOSAL	153
24.1 Disposal of the transport packing.....	153
24.2 Decommissioning.....	154
24.3 Disposal of the chamber in the Federal Republic of Germany.....	154
24.4 Disposal of the chamber in the member states of the EU except for the Federal Republic of Germany.....	155
24.5 Disposal of the chamber in non-member states of the EU.....	156
25. TECHNICAL DESCRIPTION	157
25.1 Factory calibration and adjustment.....	157
25.2 Over current protection.....	157
25.3 Definition of usable volume.....	157
25.4 Technical Data.....	158
25.5 Equipment and options (extract).....	160
25.6 Accessories and spare parts (extract).....	161
25.7 Dimensions size 240.....	163
25.8 Dimensions size 720.....	164
26. CERTIFICATES AND DECLARATIONS OF CONFORMITY	165
26.1 EU Declaration of Conformity for KBF P.....	165
26.2 EU Declaration of Conformity for KBF LQC.....	168
26.3 EU Declaration of Conformity for KBWF.....	171
26.4 Certificate for the GS mark of conformity of the “Deutsche Gesetzliche Unfallversicherung e.V.“ (German Social Accident Insurance) DGUV.....	174
27. PRODUCT REGISTRATION	176
27.1 Registering a BINDER chamber.....	176
27.2 KBF P / KBF P-UL / KBF LQC / KBF LQC-UL: Multi Management Software APT-COM™ 4 BASIC-Edition.....	177
28. CONTAMINATION CLEARANCE CERTIFICATE	178
28.1 For chambers located outside USA and Canada.....	178
28.2 For chambers located in USA and Canada.....	181

Dear customer,

For the correct operation of the chambers, it is important that you read this operating manual completely and carefully and observe all instructions as indicated. Failure to read, understand and follow the instructions may result in personal injury. It can also lead to damage to the chamber and/or poor equipment performance.

1. Safety

1.1 Personnel Qualification



The chamber must only be installed, tested, and started up by personnel qualified for assembly, startup, and operation of the chamber. Qualified personnel are persons whose professional education, knowledge, experience and knowledge of relevant standards allow them to assess, carry out, and identify any potential hazards in the work assigned to them. They must have been trained and instructed, and be authorized, to work on the chamber.

The chamber should only be operated by laboratory personnel especially trained for this purpose and familiar with all precautionary measures required for working in a laboratory. Observe the national regulations on minimum age of laboratory personnel.

1.2 Operating manual

This operating manual is part of the components of delivery. Always keep it handy for reference in the vicinity of the chamber. If selling the unit, hand over the operating manual to the purchaser.

To avoid injuries and damage observe the safety instructions of the operating manual. Failure to follow instructions and safety precautions can lead to significant risks.

	 DANGER
	<p>Dangers due to failure to observe the instructions and safety precautions. Serious injuries and chamber damage. Risk of death.</p> <ul style="list-style-type: none"> ➤ Observe the safety instructions in this Operating Manual. ➤ Follow the operating procedures in this Operating Manual. ➤ Carefully read the complete operating instructions of the chamber prior to installing and using the chamber. ➤ Keep the operating manual for future reference

	<p>Make sure that all persons who use the chamber and its associated work equipment have read and understood the Operating Manual.</p>
---	--

This Operating Manual is supplemented and updated as needed. Always use the most recent version of the Operating Manual. When in doubt, call the BINDER Service Hotline for information on the up-to-dateness and validity of this Operating Manual.

1.3 Legal considerations

This operating manual is for informational purposes only. It contains information for correct and safe installing, start-up, operation, decommissioning, cleaning and maintenance of the product. Note: the contents and the product described are subject to change without notice.

Understanding and observing the instructions in this operating manual are prerequisites for hazard-free use and safety during operation and maintenance. Images are to provide basic understanding. They may deviate from the actual version of the chamber. The actual scope of delivery can, due to optional or special design, or due to recent technical changes, deviate from the information and illustrations in these instructions this operating manual. In no event shall BINDER be held liable for any damages, direct or incidental arising out of or related to the use of this manual.

This operating manual cannot cover all conceivable applications. If you would like additional information, or if special problems arise that are not sufficiently addressed in this manual, please ask your dealer or contact us directly, e.g. by phone at the number located on page one of this manual

Furthermore, we emphasize that the contents of this operating manual are not part of an earlier or existing agreement, description, or legal relationship, nor do they modify such a relationship. All obligations on the part of BINDER derive from the respective purchase contract, which also contains the entire and exclusively valid statement of warranty administration and the general terms and conditions, as well as the legal regulations valid at the time the contract is concluded. The statements in this manual neither augment nor restrict the contractual warranty provisions.

1.4 Structure of the safety instructions

In this operating manual, the following safety definitions and symbols indicate dangerous situations following the harmonization of ISO 3864-2 and ANSI Z535.6.

1.4.1 Signal word panel

Depending on the probability of serious consequences, potential dangers are identified with a signal word, the corresponding safety color, and if appropriate, the safety alert symbol.

 DANGER
Indicates an imminently hazardous situation that, if not avoided, will result in death or serious (irreversible) injury.

 WARNING
Indicates a potentially hazardous situation which, if not avoided, could result in death or serious (irreversible) injury.

 CAUTION
Indicates a potentially hazardous situation which, if not avoided, may result in moderate or minor (reversible) injury.

NOTICE
Indicates a potentially hazardous situation which, if not avoided, may result in damage to the product and/or its functions or of a property in its proximity.























1.4.2 Safety alert symbol



Use of the safety alert symbol indicates a **risk of injury**.

Observe all measures that are marked with the safety alert symbol in order to avoid death or injury.

1.4.3 Pictograms

Warning signs			
 Electrical hazard	 Hot surface	 Explosive atmosphere	 Stability hazard
 Lifting hazard	 Scalding hazard	 High humidity	 UV light hazard
 Danger of frost	 Risk of corrosion and / or chemical burns	 Harmful substances	 Biohazard
 Pollution Hazard			
Mandatory action signs			
 Mandatory regulation	 Read operating instructions	 Disconnect the power plug	 Lift with mechanical assistance
 Environment protection	 Wear protective gloves	 Wear safety goggles	
Prohibition signs			
 Do NOT touch	 Do NOT spray with water	 Do NOT climb	



Information to be observed in order to ensure optimum function of the product.

1.4.4 Word message panel structure

Type / cause of hazard.

Possible consequences.

- ⊘ Instruction how to avoid the hazard: prohibition
- Instruction how to avoid the hazard: mandatory action.

Observe all other notes and information not necessarily emphasized in the same way, in order to avoid disruptions that could result in direct or indirect injury or property damage.

1.5 Localization / position of safety labels on the chamber

The following labels are located on the chamber:











Pictograms (warning signs)	
	Risk of injury (on outer door, UL chambers only). Observe the safety instructions in the operating manual.
	Hot surface (inner glass door above the glass door handle)
 	UV light hazard (on outer door, KBF P / KBF P-UL and KBF LQC / KBF LQC-UL only)
 Demineralized Water ONLY! 	Observe the prescribed freshwater quality (next to water inlet on the rear of the chamber; on the optional freshwater can)
  	Burning and scalding hazard (chamber rear)
Service label	
	



Figure 1: Position of labels on the chamber front (example: KBF P-UL)

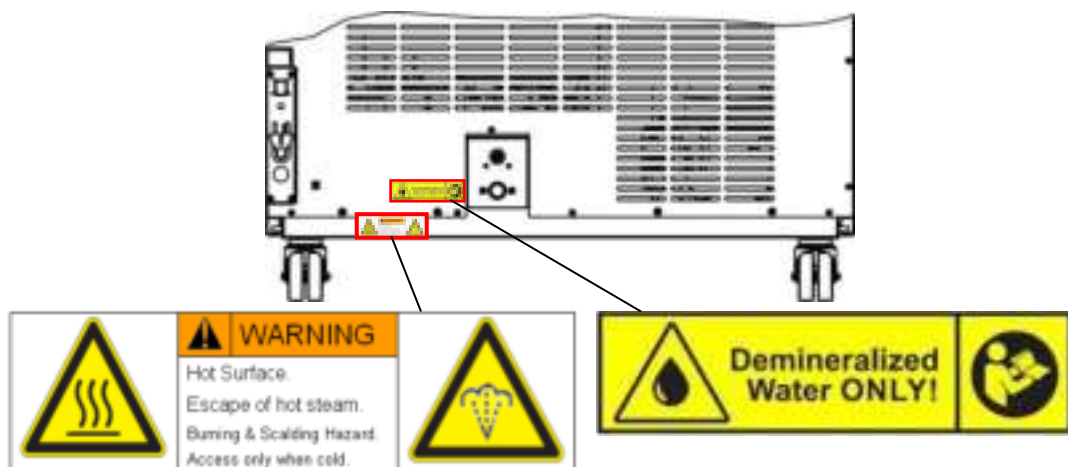

Figure 2: Position of labels on the chamber rear



Keep safety labels complete and legible.

Replace safety labels that are no longer legible. Contact BINDER Service for these replacements.



1.6 Type plate

The type plate sticks to the left side of the chamber, bottom right-hand.

Nominal temp.	70 °C 158 °F	2,40 kW / 10,9 A 200-230 V / 50 Hz	   	Max. operating pressure 15 bar R 134A – 0,575 kg Contains fluorinated greenhouse gases covered by the Kyoto Protocol	
IP protection	20	Safety device			DIN 12880
Class	3.1	Art. No.	9020-0328	Project No.	
Built	2020	Constant climate chamber			
		BINDER GmbH Im Mittleren Ösch 5 78532 Tuttlingen / Germany www.binder-world.com		KBF P 240 E6	Serial No. 0000000000000 Made in Germany

Figure 3: Type plate (example KBF P 240 regular chamber 9020-0328)

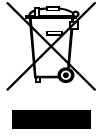
Indications of the type plate (example)		Information
BINDER		Manufacturer: BINDER GmbH
KBF P 240		Model designation
Constant climate chamber		Device name
Built	00000000000000	Serial no. of the chamber
Serial No.	2020	Year of construction
Nominal temperature	70 °C / 158 °F	Nominal temperature
IP protection	20	IP type of protection acc. to standard EN 60529
Temp. safety device	DIN 12880	Temperature safety device acc. to standard DIN 12880:2007
Class	3.1	Class of temperature safety device
Art. No.	9020-0328	Art. no. of the chamber
Project No.	---	Optional: Special application acc. to project no.
2,40 kW		Nominal power
10,9 A		Nominal current
200-230 V / 50 Hz		Nominal voltage range +/-10% at the indicated power frequency
1 N ~		Current type
Max. operating pressure 15 bar		Max operating pressure in the refrigerating system (15 bar / 218 PSI)
R 134A - 0,575 kg		Refrigerant type and filling weight
Contains fluorinated greenhouse gases covered by the Kyoto Protocol		

Symbol on the type plate	Information
	CE conformity marking
	Electrical and electronic equipment manufactured / placed on the market in the EC after 13 August 2005 and be disposed of in separate collection according to Directive 2012/19/EU on waste electrical and electronic equipment (WEEE).
	GS mark of conformity of the "Deutsche Gesetzliche Unfallversicherung e.V. (DGUV), Prüf- und Zertifizierungsstelle Nahrungsmittel und Verpackung im DGUV Test" (German Social Accident Insurance (DGUV), Testing and Certification Body for Foodstuffs and Packaging Industry in DGUV Test). (Not valid for UL chambers)

Symbol on the type plate	Information
	The chamber is certified according to Customs Union Technical Regulation (CU TR) for the Eurasian Economic Union (Russia, Belarus, Armenia, Kazakhstan Kyrgyzstan).
 (UL chambers only)	The chamber is certified by Underwriters Laboratories Inc.® according to the following standards: <ul style="list-style-type: none"> • UL 61010-1, 3rd Edition, 2012-05, Rev. 2015-07 • CAN/CSA-C22.2 No. 61010-1, 3rd Edition, 2012-05, Rev. 2015-07

1.7 General safety instructions on installing and operating the chambers



With regard to operating the chambers and to the installation location, please observe the DGUV guidelines 213-850 on safe working in laboratories, issued by the employers' liability insurance association (for Germany).

BINDER GmbH is only responsible for the safety features of the chamber provided skilled electricians or qualified personnel authorized by BINDER perform all maintenance and repair, and if components relating to chamber safety are replaced in the event of failure with original spare parts.



To operate the chamber, use only original BINDER accessories or accessories from third-party suppliers authorized by BINDER. The user is responsible for any risk caused by using unauthorized accessories.

	NOTICE
	<p>Danger of overheating due to lack of ventilation. Damage to the chamber.</p> <ul style="list-style-type: none"> ⊘ Do NOT install the chamber in unventilated recesses. ➤ Ensure sufficient ventilation for dispersal of the heat. ➤ Observe the prescribed minimum distances when installing the chamber (chap. 3.4)

Do not install or operate the chamber in hazardous locations.



	 DANGER
	<p>Danger of explosion due to combustible dusts or explosive mixtures in the vicinity of the chamber. Serious injury or death from burns and / or explosion pressure.</p> <ul style="list-style-type: none"> ⊘ Do NOT operate the chamber in potentially explosive areas. ➤ KEEP combustible dust or air-solvent mixtures AWAY from the chamber.

The chamber does not dispose of any measures of explosion protection.

	 DANGER
	<p>Danger of explosion due to introduction of flammable or explosive substances in the chamber. Serious injury or death from burns and / or explosion pressure.</p> <ul style="list-style-type: none"> ⊘ Do NOT introduce any substance into the chamber which is combustible or explosive at working temperature. ⊘ Do NOT introduce any combustible dust or air-solvent mixture in the inner chamber.



Any solvent contained in the charging material must not be explosive or inflammable. I.e., irrespective of the solvent concentration in the steam room, NO explosive mixture with air must form. The temperature inside the chamber must lie below the flash point or below the sublimation point of the charging material. Familiarize yourself with the physical and chemical properties of the charging material, as well as the contained moisture constituent and its behavior with the addition of heat energy and humidity.



Familiarize yourself with any potential health risks caused by the charging material, the contained moisture constituent or by reaction products that may arise during the temperature process. Take adequate measures to exclude such risks prior to putting the chamber into operation.

	 DANGER
	<p>Electrical hazard by water entering the chamber. Deadly electric shock.</p> <ul style="list-style-type: none"> ⊘ The chamber must NOT become wet during operation, cleaning, or maintenance. ⊘ Do NOT install the chamber in damp areas or in puddles. ➤ Set up the chamber in a splash-proof manner.

The chambers were produced in accordance with VDE regulations and were routinely tested in accordance to VDE 0411-1 (IEC 61010-1).

During and shortly after operation, the temperature of the inner surfaces almost equals the set-point. The glass doors, the glass door handles, the inner chamber, and the light cassettes will become hot during operation.

	 CAUTION
	<p>Danger of burning by touching hot chamber parts during or after operation. Burns.</p> <ul style="list-style-type: none"> ⊘ Do NOT touch the inner surfaces, the glass doors, the light cassettes or the loading material during operation.

 	 WARNING
	<p>Danger of injury and damages by the chamber tipping over or breakaway of the protruding lower housing cover. Injuries and damage to the chamber and the loading material</p> <ul style="list-style-type: none"> ⊘ Do NOT load the lower housing cover with heavy objects while the chamber door is open and do NOT climb on it.

1.8 Intended use



Following the instructions in this operating manual and conducting regular maintenance work (chap. 22) are part of the intended use.

Any use of the chambers that does not comply with the requirements specified in this Operating Manual shall be considered improper use.

Other applications than those described in this chapter are not approved.

Use



Constant climate chambers series KBF P / KBF P-UL and KBF LQC / KBF LQC-UL and growth chambers with light and humidity series KBWF are suitable for exact conditioning of harmless materials.

Requirements for the chamber load



Any solvent must not be explosive and flammable. A mixture of any component of the charging material with air must NOT be explosive. The operating temperature must lie below the flash point or below the sublimation point of the charging material. Any component of the charging material must NOT be able to release toxic gases.

The loading material shall not contain any corrosive ingredients that may damage the machine components made of stainless steel, aluminum, and copper. Such ingredients include in particular acids and halides. Any corrosive damage caused by such ingredients is excluded from liability by BINDER GmbH.

The chamber does not dispose of any measures of explosion protection.

 	 DANGER
	<p>Explosion or implosion hazard and danger of poisoning through the introduction of unsuitable loading material.</p> <p>Poisoning. Serious injury or death from burns and / or explosion pressure.</p> <ul style="list-style-type: none"> Ø Do NOT introduce any substance combustible or explosive at working temperature into the chamber, in particular no energy sources such as batteries or lithium-ion batteries. Ø NO explosive dust or air-solvent mixture in the inner chamber. Ø Do NOT introduce any substance which could lead to release of toxic gases.

Contamination of the chamber by toxic, infectious or radioactive substances must be prevented

 	 WARNING
	<p>Danger of intoxication and infection through contamination of the chamber with toxic, infectious or radioactive substances.</p> <p>Damages to health.</p> <ul style="list-style-type: none"> ➤ Protect the interior of the chamber from contamination by toxic, infectious or radioactive substances. ➤ Take suitable protective measures when introducing and removing toxic, infectious or radioactive material

In case of foreseeable use of the chamber there is no risk for the user through the integration of the chamber into systems or by special environmental or operating conditions in the sense of EN 61010-1:2010. For this, the intended use of the chamber and all its connections must be observed.

Medical devices

The chambers are not classified as medical devices as defined by the Medical Device Directive 93/42/EEC.



Due to the special demands of the Medical Device Directive (MDD), these chambers are not qualified for sterilization of medical devices as defined by the directive 93/42/EWG.

Personnel Requirements

Only trained personnel with knowledge of the Operating Manual can set up and install the chamber, start it up, operate, clean, and take it out of operation. Service and repairs call for further technical requirements (e.g. electrical know-how), as well as knowledge of the service manual.

Installation site requirements

The chambers are designed for setting up inside a building (indoor use).

The requirements described in the Operating Manual for installation site and ambient conditions (Chap. 3.4) must be met.



WARNING: If customer should use a BINDER chamber running in non-supervised continuous operation, we strongly recommend in case of inclusion of irrecoverable specimen or samples to split such specimen or samples and store them in at least two chambers, if this is feasible.

1.9 Foreseeable Misuse

Other applications than those described in chap. 1.8 are not approved.

This expressly includes the following misuses (the list is not exhaustive), which pose risks despite the inherently safe construction and existing technical safety equipment:

- Non-observance of Operating Manual
- Non-observance of information and warnings on the chamber (e.g. control unit messages, safety identifiers, warning signals)
- Installation, startup, operation, maintenance and repair by untrained, insufficiently qualified, or unauthorized personnel
- Missed or delayed maintenance and testing
- Non-observance of traces of wear and tear
- Insertion of materials excluded or not permitted by this Operating Manual.
- Non-compliance with the admissible parameters for processing the respective material.
- Installation, testing, service or repair in the presence of solvents
- Installation of replacement parts and use of accessories and operating resources not specified and authorized by the manufacturer
- Installation, startup, operation, maintenance or repair of the chamber in absence of operating instructions
- Bypassing or changing protective systems, operation of the chamber without the designated protective systems
- Non-observance of messages regarding cleaning and disinfection of the chamber.
- Spilling water or cleaning agent on the chamber, water penetrating into the chamber during operation, cleaning or maintenance.
- Cleaning activity while the chamber is turned on.
- Operation of the chamber with a damaged housing or damaged power cord
- Continued operation of the chamber during an obvious malfunction
- Insertion of objects, particularly metallic objects, in louvers or other openings or slots on the chamber
- Human error (e.g. insufficient experience, qualification, stress, exhaustion, laziness)

To prevent these and other risks from incorrect operation, the operator shall issue operating instructions. Standard operating procedures (SOPs) are recommended.

1.10 Residual Risks

The unavoidable design features of a chamber, as well as its proper field of application, can also pose risks, even during correct operation. These residual risks include hazards which, despite the inherently safe design, existing technical protective equipment, safety precautions and supplementary protective measures, cannot be ruled out.

Messages on the chamber and in the Operating Manual warn of residual risks. The consequences of these residual risks and the measures required to prevent them are listed in the Operating Manual. Moreover, the operator must take measures to minimize hazards from unavoidable residual risks. This includes, in particular, issuing operating instructions.

The following list summarizes the hazards against which this Operating Manual and the Service Manual warn, and specifies protective measures at the appropriate spots:

Unpacking, Transport, Installation

- Sliding or tilting the chamber
- Setup of the chamber in unauthorized areas
- Installation of a damaged chamber
- Installation of a chamber with damaged power cord
- Inappropriate site of installation
- Missing protective conductor connection

Normal operation

- Assembly errors
- Contact with hot surfaces on the housing
- Contact with hot surfaces in the interior and inside of doors
- Emission of non-ionizing radiation from electrical operating resources
- Contact with live parts in normal state

Cleaning and Decontamination

- Penetration of water into the chamber
- Inappropriate cleaning and decontamination agents
- Enclosure of persons in the interior

Malfunction and Damage

- Continued operation of the chamber during an obvious malfunction or outage of the heating, cooling or humidification system
- Contact with live parts during error status
- Operation of a unit with damaged power cord

Maintenance

- Maintenance work on live parts.
- Execution of maintenance work by untrained/insufficiently qualified personnel
- Electrical safety analysis during annual maintenance not performed

Trouble-shooting and Repairs

- Non-observance of warning messages in the Service Manual
- Trouble-shooting of live parts without specified safety measures
- Absence of a plausibility check to rule out erroneous inscription of electrical components

- Performance of repair work by untrained/insufficiently qualified personnel
- Inappropriate repairs which do not meet the quality standard specified by BINDER
- Use of replacement parts other than BINDER original replacement parts
- Electrical safety analysis not performed after repairs

1.11 Operating instructions

Depending on the application and location of the chamber, the operator of the chamber must provide the relevant information for safe operation of the chamber in a set of operating instructions.



Keep these operating instructions with the chamber at all times in a place where they are clearly visible. They must be comprehensible and written in the language of the employees.

1.12 Measures to prevent accidents

The operator of the chamber must observe the following rule: “Betreiben von Arbeitsmitteln. Betreiben von Kälteanlagen, Wärmepumpen und Kühleinrichtungen“ (Operation of work equipment. Operation of refrigeration systems, heat pumps and refrigeration equipment) (GUV-R 500 chap. 2.35) (for Germany).

The manufacturer took the following measures to prevent ignition and explosions:

- **Indications on the type plate**

See operating manual chap. 1.6.

- **Operating manual**

An operating manual is available for each chamber.

- **Overtemperature monitoring**

The chamber is equipped with a temperature display, which can be read from outside.

The chamber is equipped with an additional safety controller (temperature safety device class 3.1 acc. to DIN 12880:2007). Visual and audible (buzzer) signals indicate temperature exceeding.

- **Safety, measurement, and control equipment**

The safety, measuring, and control equipment is easily accessible.

- **Electrostatic charge**

The interior parts are grounded.

- **Non-ionizing radiation**

Non-ionizing radiation is not intentionally produced, but released only for technical reasons by electrical equipment (e.g. electric motors, power cables, solenoids). The machine has no permanent magnets. If persons with active implants (e.g. pacemakers, defibrillators) keep a safe distance (distance of field source to implant) of 30 cm, an influence of these implants can be excluded with high probability.

- **Protection against touchable surfaces**

Tested according to EN ISO 13732-1:2008.

- **Floors**

See operating manual chap. 3.4 for correct installation

- **Cleaning**

See operating manual chap. 23.5.

- **Examinations**

The chamber has been inspected by the “Deutsche Gesetzliche Unfallversicherung e.V. (DGUV) (German Social Accident Insurance (DGUV))” (German Social Accident Insurance (DGUV), Testing and Certification Body for Foodstuffs and Packaging Industry in DGUV Test) and bears the GS mark. Not valid for UL chambers.

UL chambers only: The chamber is certified by Underwriters Laboratories Inc.[®] according to the following standards: UL 61010-1, 3rd Edition, 2012-05, Rev. 2015-07; CAN/CSA-C22.2 No. 61010-1, 3rd Edition, 2012-05, Rev. 2015-07.

1.13 Resistance of the humidity sensor against harmful substances

The following list of harmful substances refers only to the humidity sensor and does not include any other materials incorporated in the chamber or prohibited substances in relation to explosion protection.

Some gases - especially clean gases - do not have any influence on the humidity sensor. Others do have a very small influence, whereas others may influence the sensor to a larger extent.

- The following gases do not influence the sensor and the humidity measurement: Argon (Ar), carbon dioxide (CO₂), helium (He), hydrogen (H₂), neon (Ne), nitrogen (N₂), nitrous oxide (N₂O), oxygen (O₂)
- The following gases do not or to a minor extent influence the sensor and the humidity measurement: Butane (C₄H₁₀), ethane (C₂H₆), methane (CH₄), natural gas propane (C₃H₈)
- The following gases do not, or to a minor extent influence the sensor and the humidity measurement, provided that the indicated loads are not exceeded:

		Maximum work place threshold limit value		Tolerated concentration with permanent load	
Substance	Formula	ppm	mg/m ³	ppm	mg/m ³
Ammonia	NH ₃	20	14	5500	4000
Acetone	CH ₃ COCH ₃	500	1200	3300	8000
Benzene		300	1200		150000
Chlorine	Cl ₂	0.5	1.5	0.7	2
Acetic acid	CH ₃ COOH	10	25	800	2000
Ethyl acetate	CH ₃ COOC ₂ H ₅	400	1400	4000	15000
Ethanol	C ₂ H ₅ OH	500	960	3500	6000
Ethylene glycol	HOCH ₂ CH ₂ OH	10	26	1200	3000
Formaldehyde	HCHO	0.3	0.37	2400	3000
Isopropanol	(CH ₃) ₂ CHOH	200	500	4800	12000
Methanol	CH ₃ OH	200	260	3500	6000
Methyl ethyl ketone	C ₂ H ₅ COCH ₃	200	590	3300	8000
Ozone	O ₃	0.1	0.2	0.5	1
Hydrochloric acid	HCl	2	3	300	500
Hydrogen sulphide	H ₂ S	10	15	350	500
Nitrogen oxides	NO _x	5	9	5	9
Sulphur dioxide	SO ₂	5	13	5	13
Toluol	C ₆ H ₅ CH ₃	100	380	1300	5000
Xylene	C ₆ H ₄ (CH ₃) ₂	100	440	1300	5000

These values are to be considered as approximate values. The sensor resistance largely depends on the temperature and humidity conditions during the time of exposure to harmful substances. Avoid simultaneous condensation. Tolerated error of measurement: +/- 2 % r.h. The maximum work place threshold limit value is one that can be regarded as harmless for humans.

- Vapors of oil and fat are dangerous for the sensor because they may condensate at the sensor and thus prevent its function (insulating layer). For similar reasons it is not possible to measure smoke gases.

2. Chamber description and overview

2.1 Chamber description

2.1.1 KBF P / KBF P-UL and KBF LQC / KBF LQC-UL

KBF P / KBF P-UL and KBF LQC / KBF LQC-UL constant climate chambers are equipped with a multi-functional microprocessor display controller with 2-channel technology for temperature and humidity plus a digital display accurate to one-tenth of a degree resp. 0.1% r.h. With its comprehensive program control functions, the MB2 display program controller permits the high precision performance of temperature and humidity cycles. With its microprocessor controlled humidifying and dehumidifying system the chambers are high-precision constant climate chambers.

The chambers completely meet the requirements for climatic chambers of the stipulated stability and durability tests for pharmaceutical products:

- Stability tests acc. to ICH guideline CPMP/ICH/2736/99 (Q1A)
- Photostability tests acc. to ICH guideline CPMP/ICH/279/95 (Q1B) (KBF P)

Furthermore, they permit simulating exactly and over long periods constant conditions for other applications such as sample conditioning for material testing of paper, textiles, plastics, building materials, etc.

The APT.line™ preheating chamber system guarantees high level of spatial and time-based temperature precision, thanks to the direct and distributed air circulation into the interior. The fan supports exact attainment and maintenance of the desired temperature accuracy.

KBF LQC / KBF LQC-UL: The function Light Quantum Control permits integration of UV intensity and luminous intensity inside the usable volume. The optical sensors used according to the ICH guideline for stability and durability tests of pharmaceutical products Q1B. Sensor measurement is to a great extent directionally independent, diffused light is also weighted. The function Light Quantum Control permits apart from displaying the actual values of UVA and the visible spectral range cumulative measurement of the light doses. In Manual Mode target dose values of UVA and the visible spectral range can be entered. When they are reached, the UVA and cool white fluorescent tubes are automatically turned off and notifying and alarm messages are released.

2.1.2 KBWF

KBWF growth chambers allow simulating the parameters for natural conditions, such as temperature, humidity and light. They can be universally used for conditioning of various types of charging material, even for long-term applications.

The chambers are equipped with a multifunctional microprocessor color display program controller for temperature, humidity, and illumination control. Temperature is displayed accurate to one-tenth of a degree and humidity to 0.1% r.h. With its microprocessor controlled humidifying and dehumidifying system the KBWF is a high-precision growth chamber for programmable light and climate conditions. With its comprehensive program control functions, the MB2 display program controller permits the high precision performance of temperature and humidity cycles and illumination control. Any climatic conditions can exactly be simulated constantly and precisely over long periods of time.

The chamber is regularly equipped with daylight illumination tubes. It can be optionally equipped with plant growth lamps bearing the ideal spectrum for photosynthesis and thus become the ideal growing chamber for plants under programmable climate conditions. Operative ranges are plant biotechnology, agricultural industry, forestry and timber industry, pharmaceutical and chemical industry, basic research, quality assurance and material testing. The fluorescent tubes are built in light cassettes that can be freely positioned within wide areas. They illuminate very homogeneously the racks below them. The lamps can be switched in three groups. By adequately adjusting the program controller, an automatic day/night simulation can be effected.

The horizontal air conduction of the APT.line™ preheating chamber technology, in conjunction with the controllable air turbine enables simulation of the natural air-flow conditions. The APT.line™ preheating chamber system guarantees high level of spatial and time-based temperature precision, thanks to the direct and distributed air circulation into the interior. The fan supports exact attainment and maintenance of the desired temperature accuracy.

2.1.3 General

Humidity control: A resistance humidifying system humidifies the air. For this purpose, use deionized (demineralized) water. The option BINDER Pure Aqua Service allows using the chamber with any degree of water hardness.

Material: The inner chamber, the pre-heating chamber and the interior side of the doors are all made of stainless steel V2A (German material no. 1.4301, US equivalent AISI 304). The housing is RAL 7035 powder-coated. All corners and edges are also completely coated.

All chamber functions are easy and comfortable to use thanks to their clear arrangement. Major features are easy cleaning of all chamber parts and avoidance of undesired contamination.

Controller: The efficient program controller is equipped with a multitude of operating functions, in addition to recorder and alarm functions. Programming of test cycles is easily accomplished via the modern MB2 touch screen controller and is also possible directly with a computer via Intranet in connection with the APT-COM™ 4 Multi Management Software (option, chap. 21.1). The chamber comes equipped with an Ethernet serial interface for computer communication. In addition, the BINDER APT-COM™ 4 Multi Management Software permits networking up to 100 chambers and connecting them to a PC for controlling and programming, as well as recording and representing temperature and humidity data. For further options, see chap.25.5.

The chambers are equipped with four castors. Both front castors can be easily locked via the attached brakes.

Temperature range: 0 °C / 32 °F up to 70 °C / 158 °F without light cassettes, 10 °C / 50 °F up to 60 °C / 140 °F with illumination

KBF LQC / KBF LQC-UL: When at least one light sensor is plugged-in, the maximum temperature is automatically limited to 60 °C.

Humidity range: 10% r.h. to 80% r.h.

For the control ranges of temperature and humidity, see climatic diagrams (chap. 18).

2.2 Chamber overview

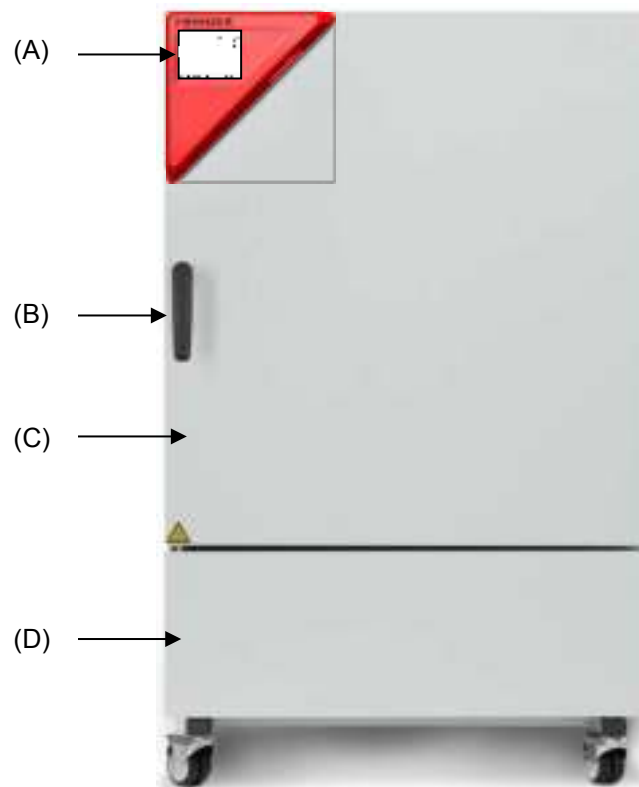

Figure 4: Constant climate chamber / Growth chamber size 240

- (A) Instrument box
- (B) Door handle
- (C) Outer door
- (D) Refrigerating machine and humidity generation module

2.3 Instrument panel

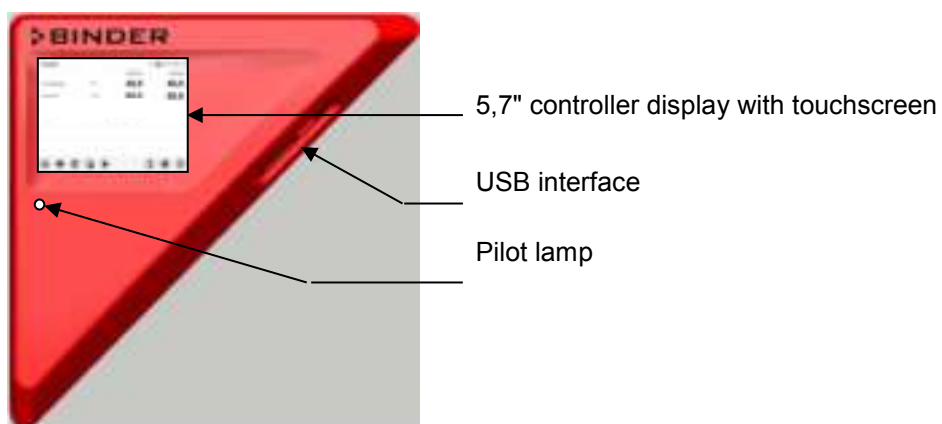

Figure 5: Instrument panel with MB2 program controller and USB interface

2.4 Lateral control panels

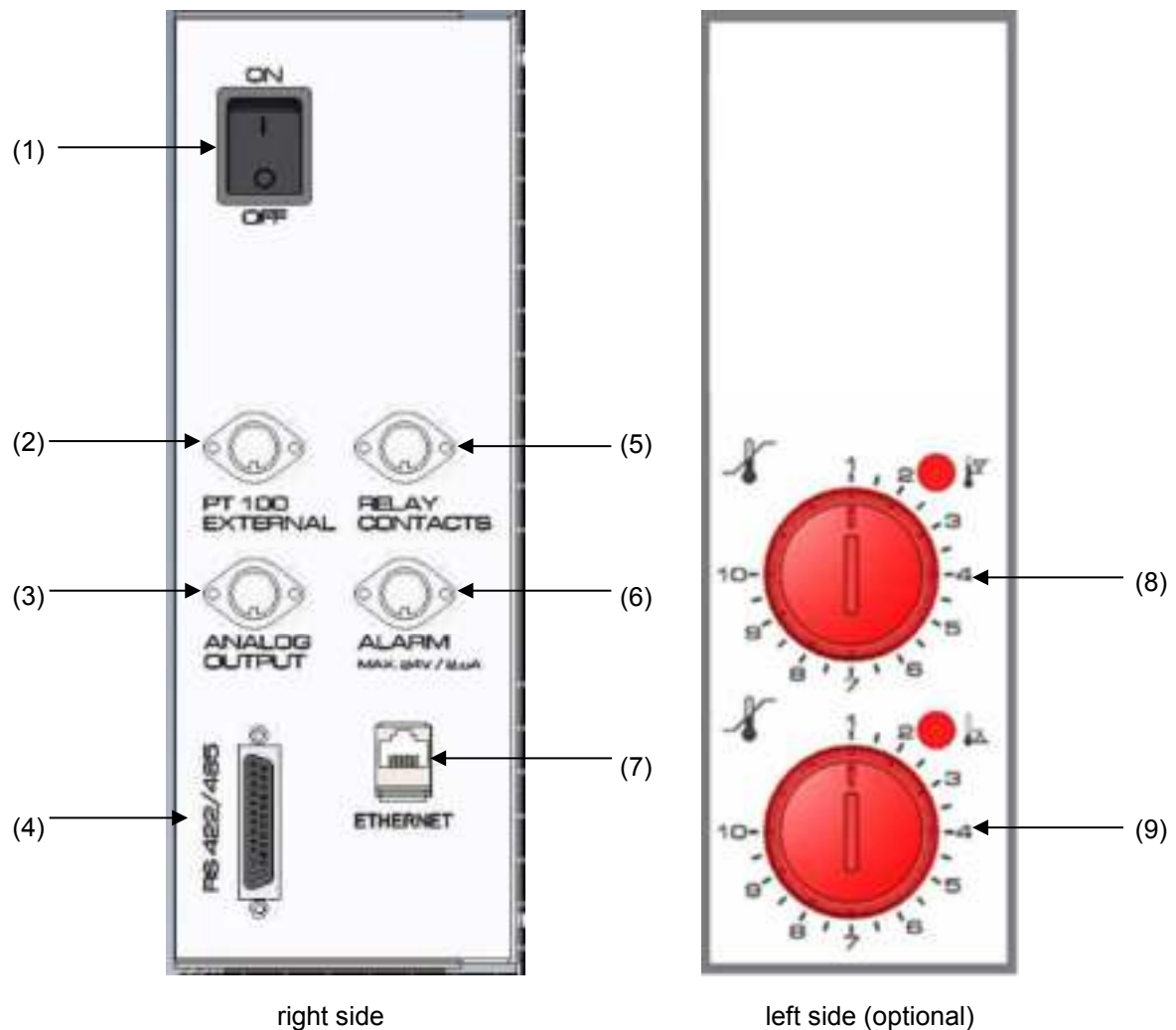

Figure 6: Lateral control panels at the sides of the refrigerating / humidity generation module with optional equipment

- (1) Main power switch
- (2) DIN socket for additional Pt 100 sensor (may be available via BINDER INDIVIDUAL customized solutions)
- (3) DIN socket for analog outputs (option)
- (4) RS485 interface
- (5) DIN socket for switching contacts (may be available via BINDER INDIVIDUAL customized solutions)
- (6) DIN socket for zero-voltage relay alarm output (option)
- (7) Ethernet interface
- (8) Temperature safety device class 3.1 (part of option "Safety device class 3.3")
- (9) Temperature safety device class 3.2 (part of option "Safety device class 3.3")

2.5 Rear view with water connections

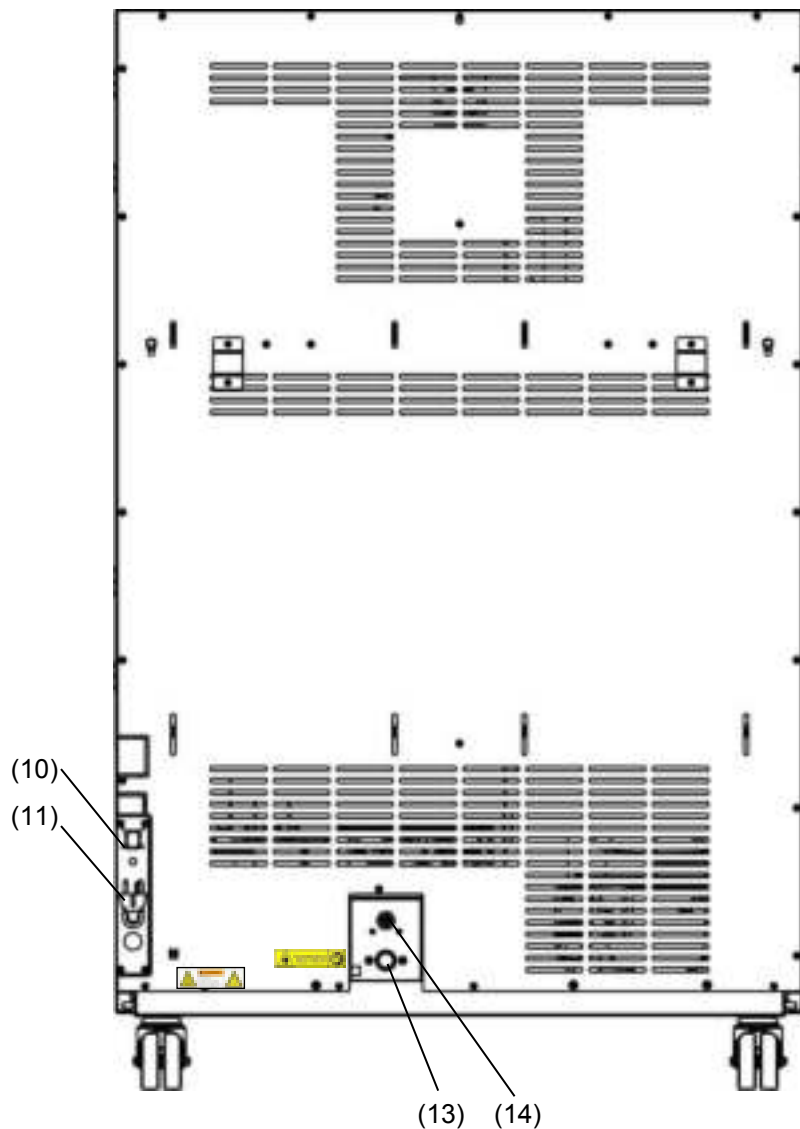

Figure 7: Rear view of the chamber with water connections

- (10) Socket for optional freshwater can (chap. 21.9.1)
- (11) Power cable
- (12) not used
- (13) Freshwater connection "IN" with screw thread $\frac{3}{4}$ " for hose $\frac{1}{2}$ ", with union nut
- (14) Wastewater connection "OUT" with hose olive for hose $\frac{1}{2}$ "





3. Completeness of delivery, transportation, storage, and installation

3.1 Unpacking, and checking equipment and completeness of delivery

After unpacking, please check the chamber and its optional accessories, if any, based on the delivery receipt for completeness and for transportation damage. Inform the carrier immediately if transportation damage has occurred.

The final tests of the manufacturer may have caused traces of the shelves on the inner surfaces. This has no impact on the function and performance of the chamber.

Please remove any transportation protection devices and adhesives in/on the chamber and on the doors and remove the operating manuals and accessory equipment.

	 CAUTION
	<p>Risk of injury and damages by lifting heavy loads and by sliding or tilting of the chamber due to improper lifting.</p> <p>Injuries, damage to the chamber.</p> <ul style="list-style-type: none"> ∅ Do NOT lift or transport the chamber using the door, the handle, or the lower housing. ∅ Do NOT lift the chamber by hand. ➤ Lift the chamber from the pallet using technical devices (fork lifter). Set the fork lifter only from the front or rear in the middle of the chamber. ∅ Do NOT set the fork lifter from the chamber side.
	

If you need to return the chamber, please use the original packing and observe the guidelines for safe lifting and transportation (chap. 3.2).

For disposal of the transport packing, see chap. 24.1.





Note on second-hand chambers (Ex-Demo-Units):

Second-hand chambers are chambers that were used for a short time for tests or exhibitions. They are thoroughly tested before resale. BINDER ensures that the chamber is technically sound and will work flawlessly.

Second-hand chambers are marked with a sticker on the chamber door. Please remove the sticker before commissioning the chamber.

3.2 Guidelines for safe lifting and transportation

The front castors can be blocked by brakes. After operation, please observe the guidelines for temporarily decommissioning the chamber (chap. 24.2). Please move the chambers with castors only when empty and on an even surface, otherwise the castors may be damaged.

  	 CAUTION
	<p>Risk of injury and damages by lifting heavy loads and by sliding or tilting of the chamber due to improper transportation.</p> <p>Injuries, damage to the chamber.</p> <ul style="list-style-type: none"> ➤ Transport the chamber in its original packaging only. ➤ For moving or shipping, secure the chamber with transport straps. ⊘ Do NOT lift or transport the chamber using the door, the handle, or the lower housing. ⊘ Do NOT lift the chamber by hand. ➤ Lift the chamber using technical devices (fork lifter). Set the fork lifter only from the front or rear in the middle of the chamber. ⊘ Do NOT set the fork lifter from the chamber side.

You can order transport packing for moving or shipping purposes from BINDER service.

Permissible ambient temperature range during transport:

- If the steam humidifying system has NOT been emptied: +3 °C / 37.4 °F to +60 °C / 140 °F.
- After BINDER Service has emptied the steam humidifying system: -10 °C / 14 °F to +60 °C / 140 °F.

With temperatures below +3 °C / 37.4 °F, water must be completely removed from the humidifying system.

	NOTICE
	<p>Danger of freezing in the steam generator when transporting the chamber below +3 °C / 37.4 °F with filled steam humidifying system.</p> <p>Damage to the chamber.</p> <ul style="list-style-type: none"> ➤ Contact BINDER Service before any transportation below +3 °C / 37.4 °F.

3.3 Storage

Intermediate storage of the chamber is possible in a closed and dry room. Observe the guidelines for temporary decommissioning (chap. 24.2).

Permissible ambient temperature range during storage:

- If the steam humidifying system has NOT been emptied: +3 °C / 37.4 °F to +60 °C / 140 °F.
- After BINDER Service has emptied the steam humidifying system: -10 °C / 14 °F to +60 °C / 140 °F

With temperatures below +3 °C / 37.4 °F, water must be completely removed from the humidifying system.

	NOTICE
	<p>Danger of freezing in the steam generator when storing the chamber below +3 °C / 37.4 °F with filled steam humidifying system.</p> <p>Damage to the chamber.</p> <ul style="list-style-type: none"> ➤ Contact BINDER Service before any storage below +3 °C / 37.4 °F.

Permissible ambient humidity: max. 70 % r.h., non-condensing

After extensive operation at humidity levels > 70% r.h., condensation from excessive humidity can lead to corrosion during storage. In this case the chamber must first be dried.

	NOTICE
	<p>Danger of corrosion on the housing due to condensation by excess humidity after operating at humidity values > 70 % r.h. for a long period.</p> <p>Damage to the chamber.</p> <ul style="list-style-type: none"> ➤ Let the chamber dry for several days before shut-down: <ul style="list-style-type: none"> • Set the humidity to 0 % r.h. To enable dehumidification, the humidifying and dehumidifying system must be activated (deactivated operation line “Humidity off”, chap. 8.4 and setting “Control on”, chap. 6.3). • Set the temperature set point to 60 °C / 140 °F for approx. 2 hours (Manual mode). • Only then, shut down the chamber at the main power switch (1) and close the tap of the water supply.

When after storage in a cold location you transfer the chamber to its warmer installation site, condensation may form. Before start-up, wait at least one hour until the chamber has attained ambient temperature and is completely dry.



In case of a prolonged temporal decommissioning: Leave the chamber door open or remove the access port plugs.

3.4 Location of installation and ambient conditions

Set up the chamber on a flat, even surface, and in a well-ventilated, dry location and align it using a spirit level. The site of installation must be capable of supporting the chamber’s weight (see technical data, chap. 25.4). The chambers are designed for setting up inside a building (indoor use).

	NOTICE
	<p>Danger of overheating due to lack of ventilation.</p> <p>Damage to the chamber.</p> <ul style="list-style-type: none"> ⊘ Do NOT install the chamber in unventilated recesses. ➤ Ensure sufficient ventilation for dispersal of the heat. ➤ Observe the prescribed minimum distances when installing the chamber.

Do not install or operate the chamber in potentially explosive areas.

	 DANGER
	<p>Danger of explosion due to combustible dusts or explosive mixtures in the vicinity of the chamber.</p> <p>Serious injury or death from burns and / or explosion pressure.</p> <ul style="list-style-type: none"> ⊘ Do NOT operate the chamber in potentially explosive areas. ➤ KEEP explosive dust or air-solvent mixtures AWAY from the vicinity of the chamber.

Ambient conditions

- Permissible ambient temperature range during operation: +18 °C / 64.4 °F to +32 °C / 89.6 °F. At elevated ambient temperature values, fluctuations in temperature can occur.

	The ambient temperature should not be substantially higher than the indicated ambient temperature of +22 °C +/- 3 °C / 71.6 °F ± 5.4 °F to which the specified technical data relate. Deviations from the indicated data are possible for other ambient conditions.
---	---

	With each degree of ambient temperature >25 °C / 77 °F, the refrigeration power decreases by 1.5 K.
---	---

- Permissible ambient humidity: 70 % r.h. max., non-condensing

When operating the chamber at temperature set-points below ambient temperature, high ambient humidity may lead to condensation on the chamber.

- Installation height: max. 2000 m / 6562 ft. above sea level.

Distances

- When placing several chambers of the same size side by side, maintain a minimum distance of 250 mm / 9.84 in between each chamber.
- Wall distances: rear 100 mm / 3.9 in, sides 160 mm / 6.29 in.
- Spacing above the chamber of at least 100 mm / 3.9 in must also be accounted for.

	<p style="text-align: center;">NOTICE</p> <p>Danger by stacking. Damage to the chambers.</p> <p>∅ Do NOT place the chambers on top of each other.</p>
--	---

Other requirements

A water tap (1 bar to 10 bar) is necessary for the installation of the humidification system (chap. 4.3). If no suitable in-house water connection is available, you can manually supply water by filling the freshwater can (option, chap. 21.9).

	To avoid any possible water damage, provide a floor drain at the location of the device. Select a suitable installation site to avoid any consequential damage by splashing water.
---	--

To completely separate the chamber from the power supply, you must disconnect the power plug. Install the chamber in a way that the power plug is easily accessible and can be easily pulled in case of danger.

For the user there is no risk of temporary overvoltages in the sense of EN 61010-1:2010.

With an increased amount of dust in the ambient air, clean the condenser fan (by suction or blowing) several times a year.

Avoid any conductive dust in the ambience according to the chamber layout complying with pollution degree 2 (IEC 61010-1).

After turning off the chamber, you must close the tap of the water supply. Install the chamber in a way that the freshwater supply is easily accessible.

With option "External freshwater and wastewater cans" (chap. 21.9): Install the chamber in a way that freshwater can is easily accessible for filling.

4. Installation and connections

4.1 Spacer for wall distance

Please fix both spacers with the supplied screws at the chamber rear. This serves to ensure the prescribed minimum distance to the rear wall of 100 mm / 3.94 in.



Figure 8: Spacer for wall distance

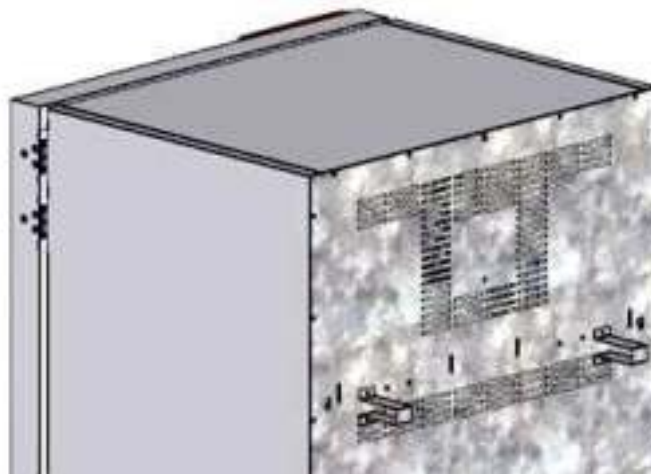

Figure 9: Rear KMF with mounted spacers

4.2 Wastewater connection

Fasten the wastewater hose to the wastewater connection "OUT" (14) on the rear of the chamber (olive \varnothing 14 mm). Observe the following points:

- You can use a part of the supplied water hose as a drainage hose. In case another hose is used, it has to be permanently resistant against at least 95 °C / 203 °F.
- Mount the wastewater hose with a maximum positive inclination of 1 m and a maximum total length of 3 m.
- Protect the chamber end of the drainage hose with one of the supplied hose clamps.
- Reliably prevent sucking back of wastewater. The end of the wastewater hose must not be immersed in liquids. This can be ensured e.g., by free discharge.



Waste water is collected in an internal can with a volume of approx. 0.5 liters. It is pumped off only when required, thus there is no continuous waste water flow.





Protect the waste water supply with the supplied hose clamps.

4.3 Freshwater supply

	Connect the waste water pipe before connecting the chamber to a freshwater pipe or filling the freshwater can (option, chap. 21.9).
---	---

You can supply the chamber with freshwater via a water pipe or by manually filling a freshwater can (option, chap. 21.9).

	Water intake temperature NOT below +5 °C / 41 °F and not exceeding 40 °C / 104 °F.
---	--

	NOTICE
	<p>Danger of calcification of the humidifying system. Damage to the chamber.</p> <p>➤ Operate the chamber with deionized (demineralized) water only.</p>

Types of suitable water quality:

- Deionized water from a water treatment installation already existing at the customer's site. Conductivity from 1 µS /cm up to a maximum of 20 µS/cm. (Water, which is in equilibrium with the CO₂ in the air, and has a conductivity below 1 µS/cm (ultrapure water), may cause acid corrosion due to its low pH).
- Water treated by the optional water treatment system BINDER Pure Aqua Service (disposable system). A reusable measuring equipment to assess the water quality is included (chap. 21.10).

	<p>BINDER GmbH is NOT responsible for the water quality at the user's site.</p> <p>Any problems and malfunctions that might arise following use of water of deviating quality are excluded from liability by BINDER GmbH.</p> <p>The warranty becomes void in the event of use of water of deviating quality.</p>
---	---

4.3.1 Automatic fresh water supply via water pipe

An enclosure inside the chamber contains the connection kit for freshwater and wastewater. Install the freshwater connection using either the enclosed water hose or another pressure-resistant one. To accomplish this, remove the cover of the freshwater connection "IN" (13) on the rear of the chamber. Protect both ends of the hose with two of the four supplied hose clamps.

Before turning on the chamber, check the connection for leaks. Water supply is automatically effected via the freshwater connection "IN" (13).

	As the appliance only lets in water when required, there is no continuous water flow.
---	---

	<ul style="list-style-type: none"> • Supply pressure 1 to 10 bar when connecting to a water pipe • Water type: deionized (demineralized) water • Water intake temperature NOT below +5 °C / 41 °F and not exceeding 40 °C / 104 °F. • The water intake should be provided with a shut-off slide or water-tap. • For the water supply, fix the delivered adapter with hose olive on the thread at the rear of the chamber. • Protect the water supply at one side with the supplied hose clamp.
---	--

4.3.2 Manual fresh water supply via external freshwater can (option)

If no house water connection with suitable water is available, you can manually supply water by filling a freshwater can (option, volume: 20 liters / 0.71 cu.ft. You can attach the freshwater can on the rear of the chamber or place it next to the chamber (chap. 21.9).



To guarantee humidification during 24 hours even at high humidity set-points with manual water supply, we recommend filling the freshwater can (option) daily at the end of the day.

4.3.3 Connection kit for connecting the chamber to the water main

A safety kit against flooding caused by burst water hoses is enclosed with the constant climate chamber. It consists of the following:

- Hose burst protection device
- 2 hose nozzles with screwing
- 4 hose clamps
- 6m water hose, divisible for the feed hose and drain

Protection principle of hose burst protection:

Whenever a strong water flow of about 18 l / min. occurs, e.g. caused by a burst water hose, a valve automatically cuts off the water supply, which can be heard as a clicking noise. The water supply now remains shut until it is manually released.

Assembly:

Screw the hose burst protection device onto a water tap with a G $\frac{3}{4}$ inch right turning thread connection. The connection is self-sealing. Establish the connection between the safety kit and the chamber with a part of the supplied hose. Protect both ends of the hose by the supplied hose clamps.

We recommend connecting the hose as the last step in order to avoid twisting the hose while screwing on the safety kit.

Open the water tap slowly in order to avoid actuating the hose burst protection device.

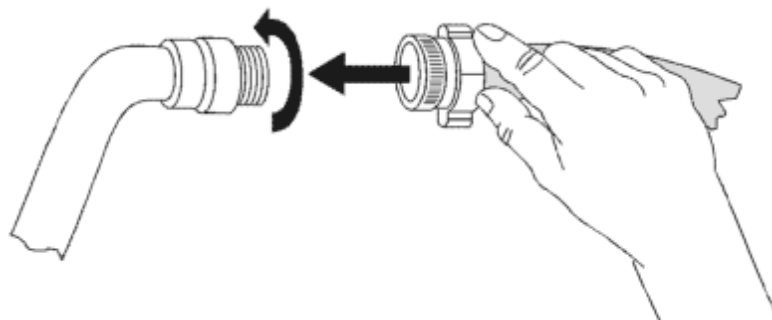



Figure 10: Assembly of the connection kit

Release of the reflux protection device:

In case the burst protection device has interrupted the water supply, first find the reason and remove it as necessary. Close the water tap. Release the valve by a half left-turn of the upper knurled part. You can hear the release of the valve as a clicking noise. Tighten the burst protection device against the water tap by a right turn. Open the water tap slowly afterwards.

Maintenance of the assembly of the hose burst protection device:

Calcification can impair valve function. We recommend an annual inspection by a skilled plumber. The plumber should demount the safety kit to check the valve by hand for function, calcification or blockage.

	NOTICE
	<p>Danger of impairment of the valve function by calcification.</p> <p>Damage to the chamber.</p> <ul style="list-style-type: none"> ➤ Have a plumber inspect the valve annually. ➤ Remove calcifications by citric acid or acetic acid solutions. ➤ Continue by testing the function and tightness of the mounted chamber

Check: Quickly open the water tap while there is no chamber connected – the valve should cut off the water flux without any delay.

4.3.4 Safety kit: Hose burst protection device with reflux protection device (available via BINDER INDIVIDUAL customized solutions)

A safety kit with a reflux protection device is available for protection of the drinking water system, and against flooding caused by burst water hoses.

Protection principles:

Whenever a strong water flow of about 18 l / min. occurs, e.g. caused by a burst water hose, a valve automatically cuts off the water supply, which can be heard as a clicking noise. The water supply now remains shut until it is manually released.

A possible endangering of the drinking water system depends on the risk potential of the charging material. Under unfavorable conditions (e.g. decreasing pressure inside the tap water system), drained off charging material could be sucked out of the chamber via the steam generator into the tap water system and therefore contaminate the drinking water. The safety kit with reflux protection device provides security in case of short-term utilization of substances with low risk potential. When using substances bearing a higher risk potential, install a pipe disconnecter to assure absolute protection. It is the user's responsibility to prevent (according to national standards) any reflux of contaminated water from getting into the drinking water system.

Assembly:

The standard supplied parts – hose burst protection device, hose nozzle with screwing – are not needed.

Screw the pre-mounted assembly of the hose burst protection and reflux protection devices onto a water tap with a G $\frac{3}{4}$ inch right turning thread connection. The connection is self-sealing. Establish the connection between the safety kit and the chamber with a part of the supplied hose. Protect both ends of the hose with the supplied hose clamps.

We recommend connecting the hose as the last step in order to avoid twisting it while screwing on the safety kit.

Open the water tap slowly in order to avoid actuating the hose burst protection device.

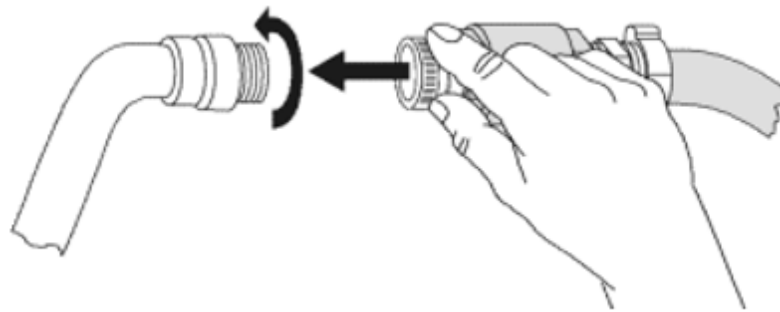



Figure 11: Assembly of the safety kit (hose burst protection and reflux protection devices)

Release of the reflux protection device:

In case the hose burst protection device interrupts the water supply, first find the reason and remove it as necessary. Close the water tap. Release the valve by a half left-turn of the upper knurled part. You can hear the release of the valve as a clicking noise. Tighten the burst protection device against the water tap by a right turn. Open the water tap slowly afterwards.

Maintenance of the assembly of hose burst protection and reflux protection devices:

Calcification can impair the function of both valves. We recommend an annual inspection by a skilled plumber. The plumber should remove the safety kit with the reflux protection device to check both valves by hand for proper function and calcification or blockage.

NOTICE	
	<p>Danger of impairment of the valve function by calcification.</p> <p>Damage to the chamber.</p> <ul style="list-style-type: none"> ➤ Have a plumber inspect the valve annually. ➤ Remove calcifications by citric acid or acetic acid solutions. ➤ Continue by testing the function and tightness of the mounted chamber

Check: Quickly open the water tap while there is no chamber connected – the valve should cut off the water flux without any delay.

4.4 Installation and connection of the light cassettes

You can insert the light cassettes in different heights onto the beads at the lateral walls of the chamber. Insert and pull out the light cassettes only by the handles.

Connect the cables of the light cassettes to its closest connection socket at the right side in the back of the chamber.

Put the waterproof plug on the connection socket. When the plug has engaged, turn the locking-nut of the plug several times to the right up to its final stopping point. The plug is now automatically sealed into the socket.

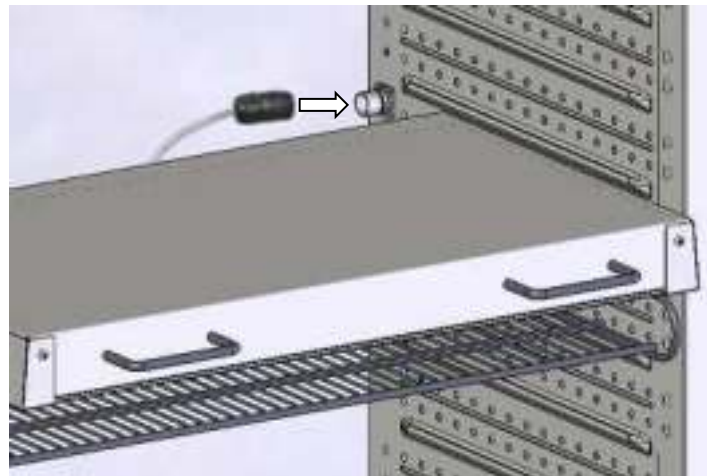

Figure 12: Connecting the light cassettes



Use the covers supplied to protect any unused connection socket.

Do not place any charging material directly onto the light cassettes because those are heated by the fluorescent tubes which would lead to exposing the charging material to undefined temperatures. The temperature directly below or on the light cassettes is not equal to the temperature displayed at the temperature controller.



Place the charging material on the supplied racks below the light cassettes.

The light cassettes will become hot with temperature set-points $>40\text{ }^{\circ}\text{C}$



CAUTION

Danger of burning when touching hot light cassettes

Burns.

- ⊘ Do NOT touch the light cassettes during operation.
- Let the light cassettes cool down before changing their position.



When operating the chamber at temperatures $> 60\text{ }^{\circ}\text{C}$ / $140\text{ }^{\circ}\text{F}$, remove the light cassettes. Otherwise, the life expectancy of the fluorescent tubes will be considerably reduced.

4.5 Connecting the light sensors – KBF LQC / KBF LQC-UL

Two light sensors to measure illumination and UV-intensity can be freely positioned in the inner chamber. The sensors are equipped with a cable of at least 1.3 m length. They are plugged in the LEMO sockets marked “V-λ SENSOR” or “UVA SENSOR” in the inner chamber.



Figure 13: Lemo sockets to connect the light sensors

The maximum ambient temperature of the light sensors is 60 °C. At higher temperatures the sensors will be destroyed.

When at least one of the light sensors is plugged in, the maximum temperature of the chamber is automatically limited to 60 °C. When exceeding the actual or set-point value of 60 °C due to an excessively high temperature set-point or an error, the message “Light sensor 60 °C!” is displayed (chap. 12.1.3). As soon as the chamber has cooled down to a value ≤ 60 °C or the set-point has been reset accordingly, the message disappears.

	NOTICE
	<p>Danger of damage to the light sensors by excessive inner chamber temperature. Destruction of the light sensors.</p> <ul style="list-style-type: none"> ⊘ With chamber temperature above 60 °C, do NOT plug-in the light sensors and do NOT leave them inside the chamber. ⊘ Do NOT set a controller set-point above 60 °C when the light sensors are inside the chamber.

If no light sensor is plugged in, protect the connection sockets by closing them with the protecting caps attached below to prevent entry of humidity and dirt accumulation at the contacts.

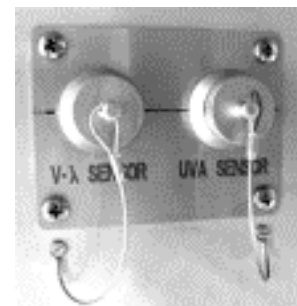

Figure 14: Connection sockets closed with protecting caps



For the characteristic features of the light sensors see chap. 20.5.

4.6 Electrical connection

The chambers are supplied ready for connection. They come with a fixed power connection cable of at least 1800 mm / 70.87 in in length.

Model version	Art. No. (x = 0 or 1)	Power plug	Voltage +/-10% at the indicated power frequency	Current type	Chamber fuse
KBWF 240 KBF P 240 KBF LQC 240	9x20-0336 9x20-0328 9x20-0332	Grounded plug	200-230 V at 50 Hz	1N~	16 Amp
KBF P 240-UL KBF LQC 240-UL	9x20-0329 9x20-0333	NEMA 6-20P	200-240 V at 50Hz 200-240 V at 60Hz	2~	16 Amp
KBWF 720 KBF P 720 KBF LQC 720	9x20-0337 9x20-0330 9x20-0334	Grounded plug	200-230 V at 50 Hz	1N~	16 Amp
KBF P 720-UL KBF LQC 720-UL	9x20-0331 9x20-0335	NEMA 6-20P	200-240 V at 50Hz 200-240 V at 60Hz	2~	16 Amp

- The domestic socket must also provide a protective conductor. Make sure that the connection of the protective conductor of the domestic installations to the chamber's protective conductor meets the latest technology. The protective conductors of the socket and plug must be compatible!

	 DANGER
	<p>Electrical hazard due to missing protective conductor connection. Deadly electric shock.</p> <ul style="list-style-type: none"> ➤ Make sure that the chamber's power plug and the power socket match and securely connect the electrical protective conductors of the chamber and the house installation.

- Prior to connection and start-up, check the power supply voltage. Compare the values to the specified data located on the chamber's type plate (left chamber side, bottom right-hand, see chap. 1.6).

	NOTICE
	<p>Danger of incorrect power supply voltage due to improper connection. Damage to the chamber.</p> <ul style="list-style-type: none"> ➤ Check the power supply voltage before connection and start-up. ➤ Compare the power supply voltage with the data indicated on the type plate.

- When connecting, please observe the regulations specified by the local electricity supply company and as well as the VDE directives (for Germany). We recommend the use of a residual current circuit breaker.
- Only use original connection cables from BINDER according to the above specification.
- Pollution degree (acc. to IEC 61010-1): 2
- Installation category (acc. to IEC 61010-1): II

See also electrical data (chap. 25.4).

	<p>To completely separate the chamber from the power supply, you must disconnect the power plug. Install the chamber in a way that the power plug is easily accessible and can be easily pulled in case of danger.</p>
---	--

Remark when operating the chamber with a power frequency of 60 Hz:



When connected to a power supply 1N~ with a frequency of 60 Hz, a leakage current of more than 3.5 mA is possible. If grounding through the power cable is insufficient or missing, the leakage current may flow through the user's body. Correct installation of the professional grade power socket provided by the user safely avoids this. Before connecting the chamber to the socket, please check its grounding contact type plug for appropriate construction and if it is undamaged.

	 DANGER
	<p>Electrical hazard by high leakage current. Deadly electric shock.</p> <ul style="list-style-type: none"> ➤ Earth connection is essential before connecting supply. Check socket before inserting plug.

4.7 Connection of the voltage changer (option for KBF P 240 / KBF LQC 240)

The voltage changer enables the constant climate chamber to operate at a power frequency of 115 Volt. It is packed separately and supplied together with the constant climate chamber.

The voltage changer is supplied with a fixed power connection cable with a NEMA 5-20P plug. It is protected against excess-current with an internal over-current release category B16A. The connection is made by the customer.

 	 CAUTION
	<p>Risk of injury and damages by lifting heavy loads and by sliding or tilting of the voltage changer due to improper lifting. Injuries, damage to the voltage changer.</p> <ul style="list-style-type: none"> ➤ Lift the voltage changer at both carrying handles from the pallet with two persons.

Do not install the voltage changer in the exhaust air flow at the rear of the constant climate chamber.

For the installation of the voltage changer next to the constant climate chamber, provide a wall distance of the constant climate chamber of approx. 0.4 m / 1.3 ft.

	NOTICE
	<p>Danger of overheating due to lack of ventilation. Damage to the voltage changer.</p> <ul style="list-style-type: none"> ⊘ Do NOT install the voltage changer in unventilated recesses. ➤ Ensure sufficient ventilation for dispersal of the heat.

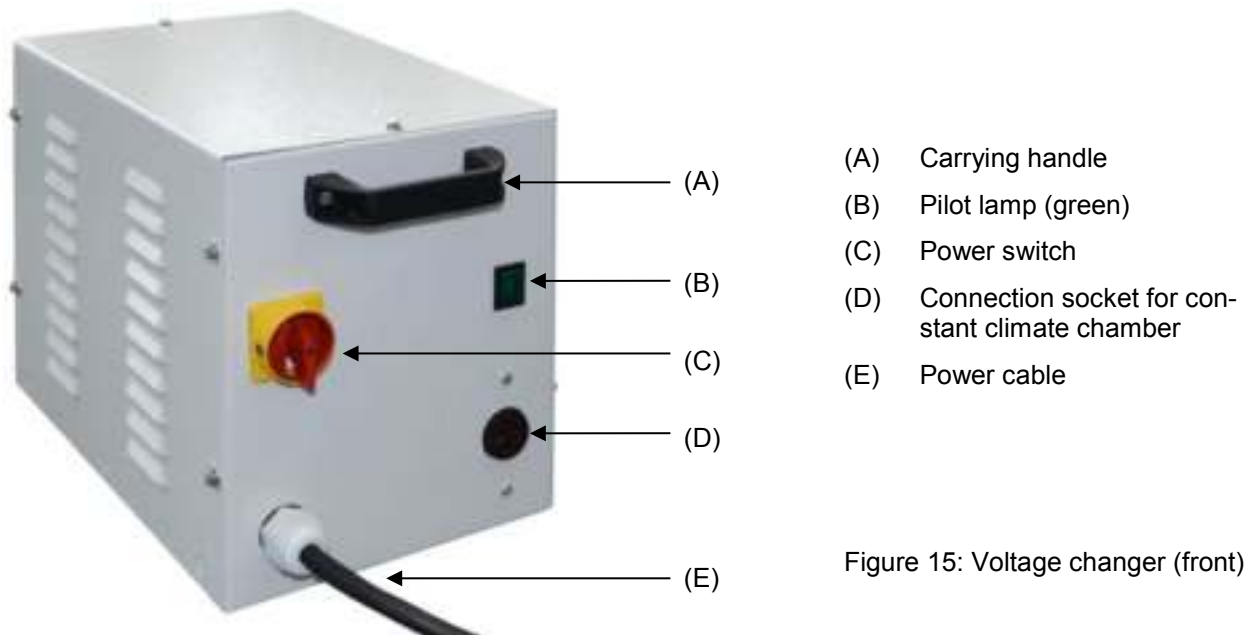

To establish the electrical connection of the constant climate chamber with the voltage changer, proceed in the following order:

1. Connect the power cable of the constant climate chamber to the connection socket (D) of the voltage changer
2. Establish the power connection of the voltage changer. The socket must provide a protective conductor.
3. Turn on the voltage changer at the power switch (C) (position "I"). The green pilot lamp (B) lights up.
4. Turn on the constant climate chamber with the main power switch (1) in the lateral control panel



Position "0" = off



Position "I" = on

Figure 16: Power switch of the voltage changer

Dimensions of the voltage changer		
Height	mm	255
Depth (without door handles)	mm	360
Depth (incl. cable and door handles)	mm	450
Height	mm	300
Length of the connection cable to wall socket	mm	172
Lateral wall clearance of the constant climate chamber to set up the voltage changer (minimum)	mm	400
Electrical connection data of the voltage changer		
Input side	V	115
	A	26,9
Output side (to the chamber)	V	214
	A	13,0
Power frequency	Hz	50 / 60

5. Functional overview of the MB2 chamber controller

The MB2 chamber controller controls following parameters inside the chamber:

- Temperature in °C
- Relative humidity in % r.h.
- Fan speed in %
- Illumination

KBF LQC / KBF LQC-UL: In addition to displaying the actual values of UVA and the visible spectral range, the function "Light Quantum Control" permits cumulative measurement of the light doses. In Manual Mode you can enter target dose values of UVA and the visible spectral range. When they are reached, the UVA, and cool white fluorescent tubes automatically turn off independently from each other.

For the control ranges of temperature and humidity, see climatic diagrams (chap. 18).

You can enter the desired set point values in fixed value operation mode directly on the display surface or via the setpoint menu. For program operation the controller offers programming week and time programs. In addition there is a timer program available (stopwatch function).

The controller offers various notifications and alarm messages with visual and audible indication and remote alarms via e-mail, an event list (trace file) and the graphical display of the measuring values in the chart recorder view. The MB2 program controller permits programming temperature and humidity cycles, and specifying illumination, fan speed and special controller functions for each program section. You can enter values or programs directly at the controller or use the APT-COM™ 4 Multi Management Software (option) specially developed by BINDER.

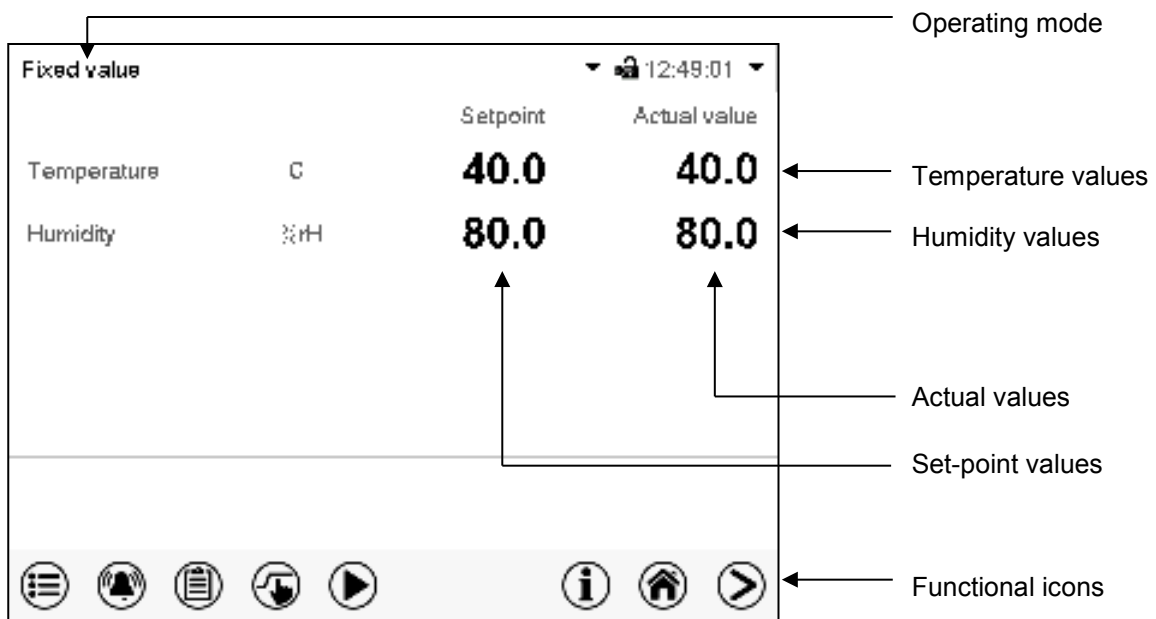

Figure 17: Normal display of the MB2 program controller (sample values) with KBF P / KBF P-UL / KBWF

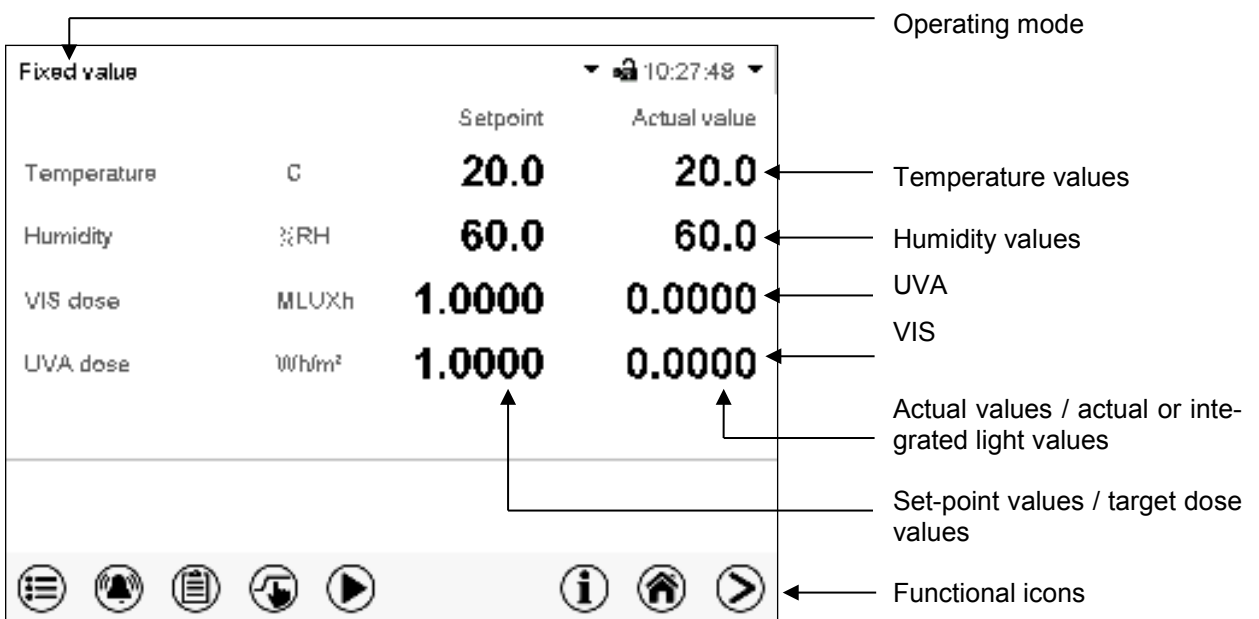

Figure 18: Normal display of the MB2 program controller (sample values) with KBF LQC / KBF LQC-UL

5.1 Operating functions in normal display

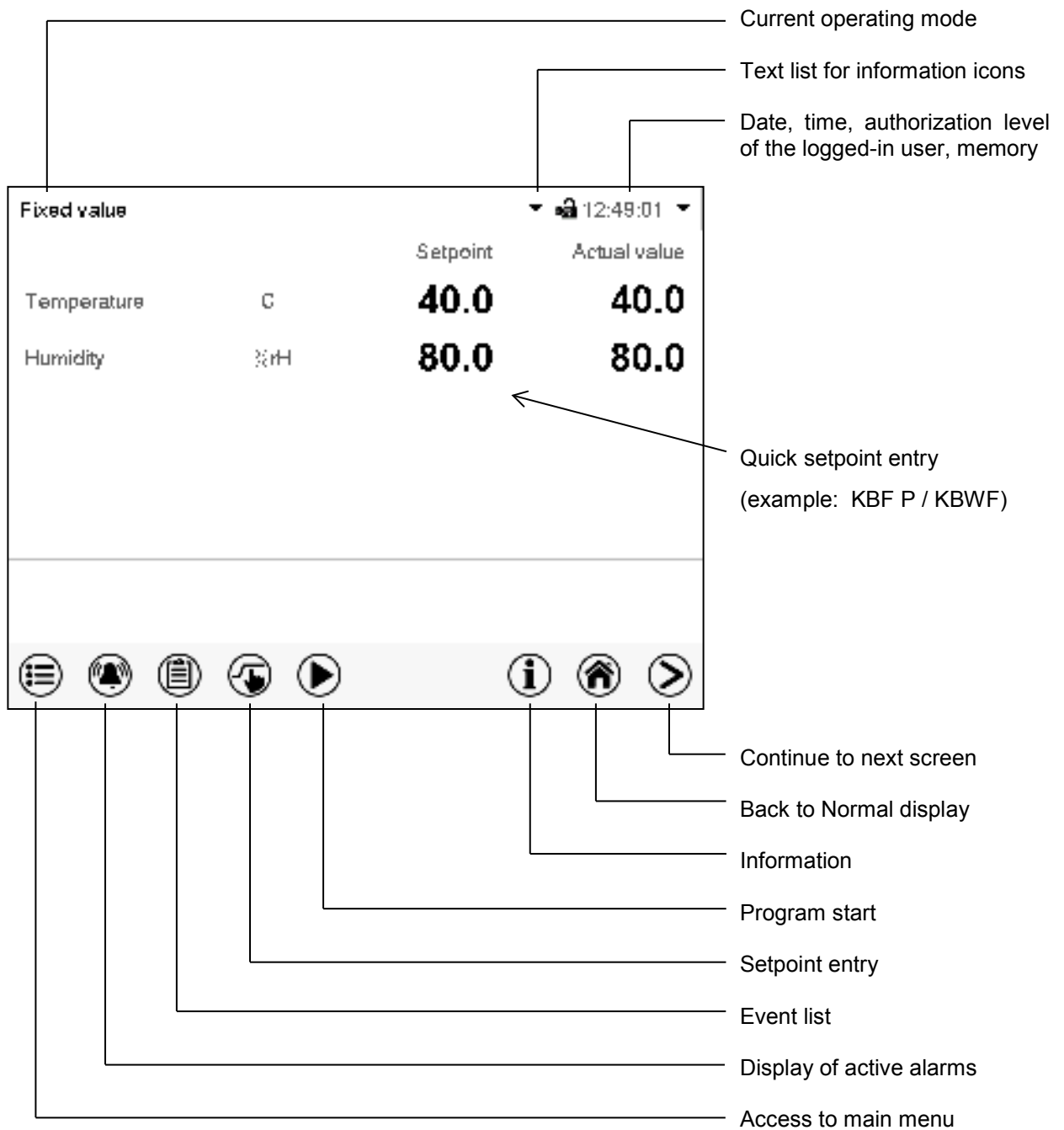

Figure 19: Operating functions of the MB2 controller in normal display (sample values)

5.2 Display views: Normal display, program display, chart-recorder display

	Press the Change view icon to toggle between normal display, program display and chart-recorder display.
	Press the Normal display icon to return from program display and chart recorder display back to Normal display.



Normal display (actual values / setpoint values)
(example: KBF P / KBWF)



Program display (example: time program)

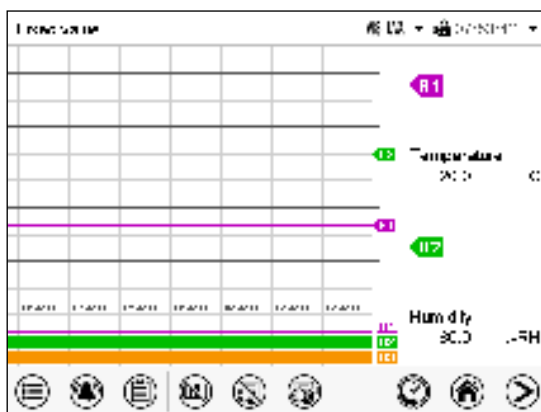



















Chart recorder display

5.3 Controller icons overview

Navigation icons in Normal display

Icon	Signification	Function
	Main menu	Access from Normal display to the main menu
	Alarm	Access from Normal display to the list of active alarms
	Event list	Access from Normal display to the event list
	Setpoint setting	Access from Normal display to the setpoint entry menu: setpoint entry for Fixed value operation, turning on/off humidity control, safety controller settings
	Program start	Start a previously entered time or week program, continue a paused time program
	Program pause	Pause a running time program
	Program cancelling	Cancel a running time or week program
	Information	Information on program operation, setpoints, actual values, and the safety controller
	Normal display	Return from program display or chart recorder display to Normal display
	Change view	Toggle between Normal display, program display, and chart recorder display











Functional icons in individual menus

Icon	Signification	Function
	Back	Return from each menu to Normal display
	Update	Update the event list and alarm messages
	Confirm	Take over the entries and exit the menu / continue menu sequence.
	Close	Exit the menu / cancel menu sequence. Entries are not taken over. When terminating a menu sequence, an information window appears, which must be confirmed.
	Reset alarm	Acknowledge the alarm and mute the buzzer.
	Change keyboard	Change between uppercase and lower case characters, digits and special characters
	Edit	Edit settings of time and week programs







Information icon for data processing

Icon	Information
	Waiting icon: Data processing is running. Remaining time to touch the display when calibrating the touchscreen.

Functional icons in the chart recorder display

Icon	Signification	Function
	Show legend	Show legend
	Hide legend	Hide legend
	Switch legend	Switch between legend pages
	Show indications	<i>KBF P / KBF P-UL, KBF LQC / KBF LQC-UL</i> :: Show the indications "Door open" (B1), "Light UVA" (B2), and "Light VIS" (B3) <i>KBWF</i> : Show the indications "Door open" (B1), "Light Level 1" (B2), and "Light Level 2" (B3).
	Hide indications	<i>KBF P / KBF P-UL, KBF LQC / KBF LQC-UL</i> :: Hide the indications "Door open" (B1), "Light UVA" (B2) and "Light VIS" (B3) <i>KBWF</i> : Hide the indications "Door open" (B1), "Light Level 1" (B2) and "Light Level 2" (B3).
	History display	Pause chart recorder and change to history display. Data recording continues.
	Curve selection	Go to "Curve selection" submenu in the history display
	Search	Go to "Search" submenu in the history display to select the required instant
	Zoom	Go to "Zoom" submenu in the history display to select the zoom factor
	Show scroll buttons	Show scroll buttons in the history display to scroll to an instant
	Hide scroll buttons	Hide scroll buttons in the history display to scroll to an instant

Information icons referring to chamber conditions

Icon	Text information	Condition
	"Idle mode"	Controller in Idle mode
	"Temperature range"	Current actual temperature value outside the tolerance range
	"Humidity range"	Current actual humidity value outside the tolerance range
	"Door open"	Chamber door is open
	"Humidity off"	The humidification / dehumidification system is turned off
VIS	"Light VIS"	<i>KBF P / KBF P-UL, KBF LQC / KBF LQC-UL</i> :: VIS light turned on (operation line "Light VIS" activated)
UVA	"Light UVA"	<i>KBF P / KBF P-UL, KBF LQC / KBF LQC-UL</i> :: UVA light turned on (operation line "Light UVA" activated)
LQC	"LQC On"	<i>KBF LQC / KBF LQC-UL</i> :: Light integration activated (operation line "LQC On" activated)
	"Light level 1"	<i>KBWF</i> : Light level 1 (40% illumination) turned on (operation line "Light level 1" activated)
	"Light level 2"	<i>KBWF</i> : Light level 2 (60 % illumination) turned on (operation line "Light level 2" activated)

5.4 Operating modes

The MB2 program controller operates in the following operating modes:

- **Idle mode**

The controller is not functional, i.e., there is no heating or refrigeration and no humidification or dehumidification. The fan is off. The chamber approximates ambient values.

The fluorescent tubes are off.

You can activate and deactivate this operating mode with the “Idle mode” control contact in Fixed value operating mode (chap. 8.4), time program operation (chap. 10.7.3) and week program operation (chap. 11.6.5).

- **Fixed value operating mode**

The controller operates as a fixed-point controller, i.e., set-points for temperature, humidity, and fan speed can be defined, which are then maintained until the next manual change (chap. 8.1).

- **Timer program operation**

Stopwatch function: during an entered duration the controller constantly equilibrates to the setpoints entered in Fixed value operation mode.

- **Time program operation**

An entered time program for temperature and humidity is running. The controller offers 25 program memory places with 100 program sections each. The total number of program sections of all programs is unlimited

- **Week program operation**

An entered week program for temperature and humidity is running. The controller offers 5 program memory places with 100 switching points each. The switching points can be distributed over all days of the week.



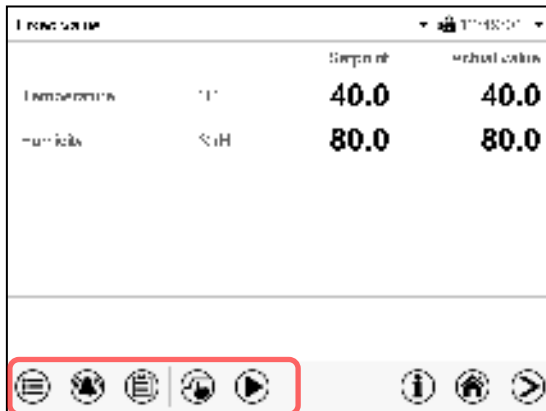

5.5 Controller menu structure

Use the **navigation icons** in the screen footer in Normal display to access the desired controller functions.



Normal display (example: KBF P / KBWF)



The available functions depend on the current **authorization level** “Service”, “Admin” or “User” (chap. 14.1). This is selected either during login or can be available without password protection.

	Main menu: program settings, further information, “Service” submenu. The “Settings” submenu allows general configuration of the controller.	chap. 5.5.1
	List of active alarms	chap. 12
	Access to the event list	chap. 16.2
	Setpoint entry for Fixed value operation, turning on/off humidity control , safety controller settings	chap. 8, 6.3, 13.2
	Start/ pause/ cancel an already entered, respectively a running time program or start / cancel an already entered, respectively a running week program	chap. 10.1, 10.2, 11.1

Unless noted otherwise, the figures show the functional range, which is available for the user with “Admin” authorization level.

5.5.1 Main menu

The main menu provides access to the general configuration of the controller as well as to program entry and the user administration. Additionally there are support functions like a contact page or the display calibration depending on the available angle.

	Press the Main menu icon to access the main menu from Normal Display.
	Press the Back icon to return from each setting menu to Normal Display.

The main menu provides the following functions and submenus.

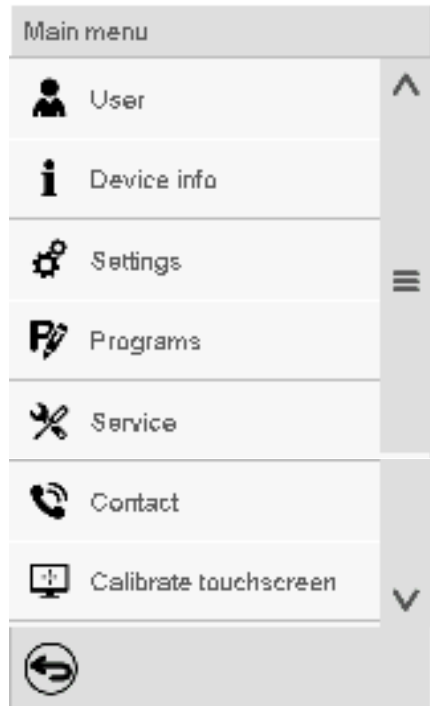
		
	User management: login and logout, password management	chap. 14
	Chamber information	chap. 16.2
	“Settings” submenu (not visible for user with “User” authorization level)	chap. 15
	Program entry submenu for time and week programs	chap. 10 and 11
	“Service” submenu	chap. 5.5.3
	BINDER Service contact page	chap. 16.1
	Calibrating the touch screen	chap. 15.4.2
	Back to Normal Display	

“Settings” submenu

- Settings of many general controller functions and network settings (chap. 15).
- Available only for users with “Service” and “Admin” authorization level

“Service” submenu

- Access to service data, controller reset to factory settings (chap. 5.5.3)
- Available only for users with “Service” and “Admin” authorization level. Full functional range only for BINDER Service (users with “Service” authorization level).

“Programs” submenu

- Access to the controller’s program functions (chap. 9, 10, 11)

5.5.2 “Settings” submenu

The “Settings” submenu is available for users with “Service” or “Admin” authorization level. It serves to enter date and time, select the language for the controller menus and the desired temperature unit and to configure the controller’s communication functions.

Path: [Main menu](#) > [Settings](#)

	Setting the temperature unit, menu language...	chap. 15.1, 15.2
	Setting date and time	chap. 15.2
	Setting the display brightness, continuous operation and screen saver	chap. 15.4
	Settings for the measurement chart: storage interval, storage values, minimum and maximum values	chap. 17.2
	Setting the tolerance range and delay time for tolerance range alarm	chap. 12.4
	Configuration of the optional RS485 interface, setting of the device address	chap. 15.5.1
	Entry of the MAC address and IP address	chap. 15.5.2
	Password protection for web server access	chap. 15.5.3
	Configuration of the e-mail server, assignment of e-mail addresses	chap. 15.5.4
	Back to main menu	

5.5.3 “Service” submenu

The “Service” submenu is available for users with “Service” or “Admin” authorization level. When logged-in with “Admin” authorization level the user will find information to tell the BINDER Service in service case.

Path: [Main menu](#) > [Service](#)

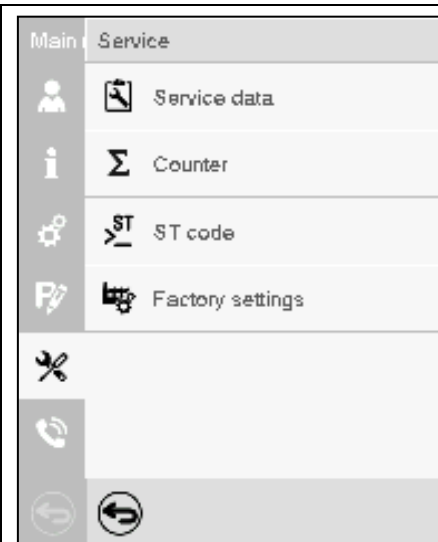
	Serial number of the chamber, setup version of the controller software	for BINDER Service
	No function	
	Information for BINDER Service	for BINDER Service
	Reset to factory settings	for BINDER Service
	Back to main menu	

(view with “Admin” authorization level)

5.6 Principle of controller entries

In the selection and entry menus there are icons displayed in the footers which you can use to take over the entry or cancel it.

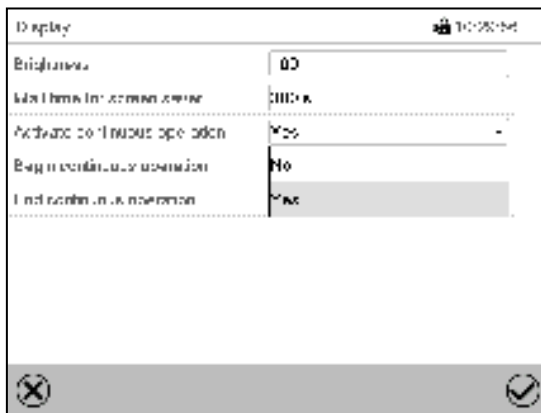



Selection menu (example)



Entry menu (example)

After completing the settings there are the following possibilities:

	Press the Confirm icon to take over the entries and exit the menu or continue the menu sequence.
	Press the Close icon to exit the menu or cancel the menu sequence without taking over the entries. When terminating a menu sequence, an information window appears, which must be confirmed.

5.7 Performance during and after power failures

During a power failure, all controller functions are shut down. The zero-voltage relay alarm output (option, chap. 21.5) is switched to alarm position for the whole duration of the power failure.

After the power returns, all functions return to the same status the chamber had before power failure. The controller continues to function in the original operating mode it was in previously before the power failure occurred.

- Performance after power failure in Idle mode
Control is deactivated
- Performance after power failure in Fixed value operation mode
All functions return to the same status the chamber had before power failure. The set-points are immediately resumed.
- Performance after power failure during time program operation
The program is resumed at the point where the interruption occurred with the latest set-points reached during the program run.
- Performance after power failure during week program operation
The week program continues with the values corresponding to the current time.

Power failure and power return are noted in the event list (chap. 16.3).

If during power failure an alarm has occurred (tolerance range, safety controller, temperature safety device class 3.3 (option), confirm the alarm. See chap. 12.3.

KBFLQC / KBFLQC-UL: Exposition with radiation is continued in the same way as it had been set manually or automatically before power failure. Integration of the light values continues with the dose values reached before power failure.

5.8 Performance when opening the door

When you open the door the fan starts running with minimum speed.

After 60 seconds from opening the door, heating, refrigeration, humidification, dehumidification and fan turn off.

After closing the door, heating, refrigeration, humidification, dehumidification and fan turn on again.

6. Start up

6.1 Turning on the chamber

- After connecting the supply lines (chap. 4), turn on the chamber by its main power switch (1). The lit pilot lamp shows the chamber is ready for operation.

When the main power switch is turned on and yet the controller display is dark, the display is in stand-by mode. Press on the touchscreen to activate it.

- Open the water-tap for freshwater supply. Alternatively, fill the freshwater can (option, chap. 21.9).
- The humidifying and dehumidifying system must be activated (deactivated operation line “Humidity off”, chap. 8.4 and setting “Control on”, chap. 6.3).
- *KBF LQC / KBF LQC-UL*: When operation line “LQC” is activated, light integration takes place: In fixed value and program operation mode, the fluorescent tubes automatically turn on until they reach the selected target dose values of UVA and the visible spectral range. If the operation line “Idle mode” is activated, the fluorescent tubes are off. In the chart recorder display, the actual values are displayed under “Instantaneous values” and the integrated light values under “Dose values”.

After the first turning on of the chamber or after an interruption of the power supply the relative humidity will increase after a delay of about 20 minutes. During this period, the relative humidity can drop considerably.

Warming chambers may release odors in the first few days after commissioning. This is not a quality defect. To reduce odors quickly we recommend heating up the chamber to its nominal temperature for one day and in a well-ventilated location.



WARNING: If customer should use a BINDER chamber running in non-supervised continuous operation, we strongly recommend in case of inclusion of irrecoverable specimen or samples to split such specimen or samples and store them in at least two chambers, if this is feasible.

6.2 Controller settings upon start up

The window „Language selection“ enables the **language selection**, in case that it's activated in the “Start-up” menu. Afterwards occurs a request of the **time zone** and the **temperature unit**.

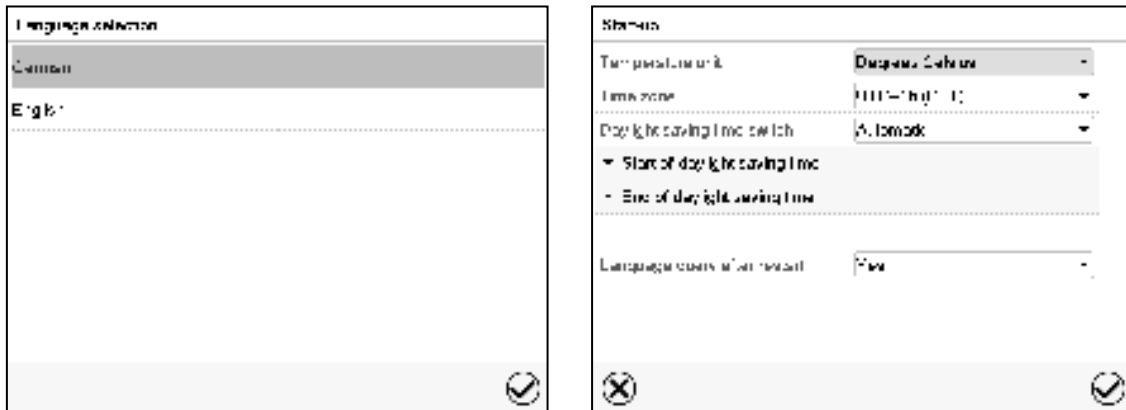

The controller will function in the **operating mode**, which was active before the last shut-down. It controls temperature and humidity in fixed value operating mode to the last entered values and in the program mode to the set points achieved beforehand.

Locked operation

Provided that the user administration has been activated by the assignment of passwords for the different authorization types, the **controller operation** is first locked after turning on the unit, recognizable by the closed lock icon in the header.

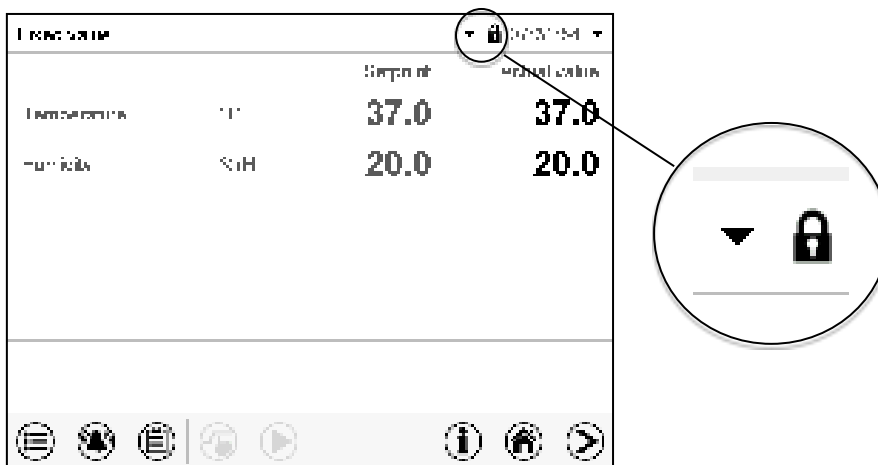

In the locked view the controller provides all display functions. No setting functions are available.

The setpoints are shaded (light grey) in normal display. Changing them by direct entry in the fixed value operating mode is not possible. The functional icons for setpoint entry and program start in the footer are without function.

After turning on the unit, user log-in is required to operate the controller (chap. 14.2)

Operation without user log-in / without password-protection

If the password function has been deactivated, after turning on the unit without user log-in there are those controller functions available, which correspond to the highest authorization level without a password protection. There is no lock icon in the header.

6.3 Turning on/off humidity control

Turning off humidity control is required when operating the chamber without water connection in order to avoid humidity alarms. For further information see chap. 18.



Press the **Setpoint setting** icon to access the “Setpoint” setting menu from Normal display.



“Setpoints” menu.

Select “Control on/off”.

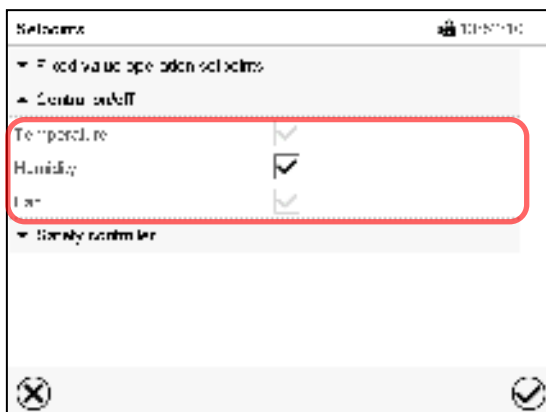

Display with KBF P / KBF P-UL and KBWF

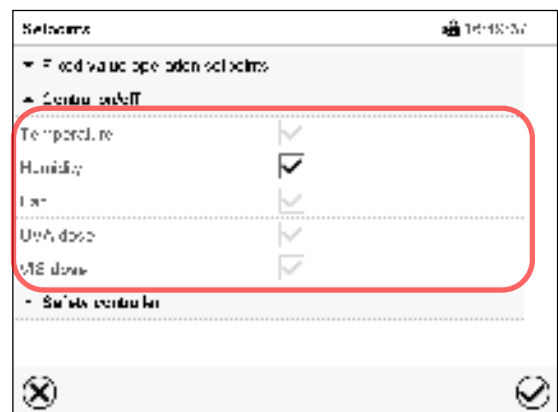

Display with KBF LQC / KBF LQC-UL

You can turn humidity control (humidification and dehumidification) on or off.

If the “Humidity” checkbox is marked, humidity control is active. Mark / unmark the checkbox to change the setting.

7. Function of light measurement, and integration: Light Quantum Control – KBF LQC / KBF LQC-UL

The chamber is equipped with fluorescent tubes for UVA and the visible spectral range. These fluorescent tubes can be turned on with the operation lines “Light VIS” and “Light UVA”.

When operation line “LQC On” is activated, the fluorescent tubes can also be turned on in fixed value or program operation mode by entering a dose target value, which is higher than a dose value already reached. As long as the operation lines “Light VIS” and “Light UVA” are not activated, the fluorescent tubes automatically turn off when the respective dose target value is reached. Operation lines “Light VIS” and “Light UVA” permit turning on the fluorescent tubes independent from automatic turn-off (or to prevent automatically turning-off) and thus to attain dose target values which are higher than the entered maximum dose. This permits turning on and off the UVA and the VIS tubes independently.

The intensities of illumination [LUX] and UVA [W/m^2] are measured by optical sensors in the inner chamber (instantaneous value display) and are integrated temporally (dose value display), i.e. the doses of illumination [MLUXh] and UVA [Wh/m^2] increase every minute by the respective actual value. In the chart recorder display the instantaneous values are shown under “Instantaneous values” and the integrated light values under “Dose values”. The instantaneous value display serves to help the user find a representative measuring spot after charging and to control the correct function of the illumination equipment.

In fixed value or program operation mode, you can numerically enter target dose values for UVA and visible light.

- When the **VIS target dose is reached** the corresponding line in Normal Display is highlighted in green, and the message “VIS dose reached” is displayed in the event list.
- When the **UVA target dose is reached** the corresponding line in Normal Display is highlighted in green, and the message “UVA dose reached” is displayed in the event list.
- As soon as the second target dose is reached as well, in addition the **alarm message** “VIS and UVA doses reached” is displayed, and a buzzer sounds. The alarm can be acknowledged on the controller. The alarm message is displayed in the event list.
- If the operation lines “Light VIS” and “Light UVA” are not activated, the according **fluorescent tubes turn off** to avoid exceeding the selected dose. If the operation lines “Light VIS” and “Light UVA” are activated, exposure to illumination and integration continue even after the message until the operation lines will be deactivated.

7.1 Display of the instantaneous and the integrated values

The instantaneous values and the dose values of VIS and UVA are constantly measured. The dose values (set-point and actual values) are always shown in Normal Display independent on the controller operation mode. Additionally in the chart recorder display the instantaneous values (actual values) are shown under “Instantaneous values” and the integrated light values (set-point and actual values) under “Dose values”, see chap. 17.

7.2 Measurement of illumination intensity and temporal integration

Operation line “LQC On” serves to start and stop the integrative function and to reset the integrated values of UVA and VIS. Operation lines “LQC reset VIS” and “LQC reset UVA” serve to reset to zero the integrated values once in a time.

- **Integrative function: Operation line “LQC On” not activated**

The LQC symbol in the screen header indicates that the integrative function has been activated via operation line “LQC On”.

Integration takes place as soon as operation line “LQC On” is activated, and at least one target dose value other than 0.0 has been entered. With target dose value 0.0, or in case the entered target dose value has been reached, the fluorescent tubes do not turn on automatically. The illumination can be turned on and off with the operation lines “Light VIS” and “Light UVA”.

Every minute the integrated values of UVA and VIS increase by the respective instantaneous value. The displayed units are Wh/m² and MLUXh. The maximum value of the integrated value display is the respective value reached with the last addition before exceeding 99999. The integration display on the controller display will then not increase any longer. Recording by the APT-COM™ 4 Multi Management Software (option, chap. 21.1) can continue correctly until overflow of the numeral format Floating Point.

In fixed value and program operation mode the illumination equipment automatically turns on when entering a dose target value higher than a dose value already reached. Additionally activating operation lines “Light VIS” and “Light UVA” can prevent the automatic turning-off when the target dose value has been reached.

If operation line “Idle mode” is activated, the integrative function is not active. The illumination is off.

Integration continues until operation line “LQC On” is deactivated. The integrated values reached so far continually remain stored but are not displayed. Integration can be continued any time.

- **Resetting the integrated values**

Operation lines “LQC Reset VIS” and “LQC Reset UVA” serve to reset to zero **the integrated values** of UVA and VIS once in a time. To do this, the corresponding operation line must be activated for at least 5 seconds (consider when programming!). The reset is effective once, i.e. for a repeated reset, first deactivate the operation line (clear the checkbox and confirm) and then activate it again.

- **Operation line “LQC On” not activated**

There is no integration. Previously reached integrated values, if any, remain stored but are not displayed.

You can turn on the fluorescent tubes with the operation lines “Light VIS” and “Light UVA”.

The symbols “VIS” and “UVA” in the screen header indicate that the corresponding fluorescent tubes have been activated with the operation lines “Light VIS” and “Light UVA”.

8. Set-point entry in “Fixed value” operating mode

In Fixed value operating mode you can enter a temperature set-point, a humidity set-point, the fan speed, and the switching-state of up to 16 operation lines.

All settings made in Fixed value operating mode remain valid until the next manual change. They are saved also when turning off the chamber or in case of toggling to Idle Mode or Program Mode.

	Setting ranges	Control ranges
Temperature	-5 °C / 41 °F up to 70 °C / 158 °F.	0 °C / 32 °F up to 70 °C / 158 °F without humidity 10 °C / 50 °F up to 70 °C / 158 °F with humidity Control ranges with illumination see technical data, chap. 25.4 <i>KBF LQC / KBF LQC-UL</i> : When at least one light sensor is plugged-in, the maximum temperature is automatically limited to 60 °C.
Humidity	0 % r.h. up to 80 % r.h.	10 % r.h. to 80 % r.h. Control ranges with illumination see technical data, chap. 25.4 See climatic diagrams, chap. 18.
<i>KBF LQC / KBF LQC-UL</i> : UVA	0.0 Wh/m ² up to 99999 Wh/m ²	The actual dose values of VIS and UVA are constantly measured and shown in Normal Display together with the dose target values. When operation line “LQC On” is activated and the target dose value is higher than the actual dose value been entered, integration takes place.. When reaching the target dose values the fluorescent tubes automatically turn off, if they had not been additionally activated with the operation lines “Light VIS” and “Light UVA”. Also corresponding messages are displayed. For operating and principle of measurement, see chap. 7.
<i>KBF LQC / KBF LQC-UL</i> : VIS	0.0 MLUXh up to 99999 MLUXh	
Fan speed	40% up to 100 %	



Reduce the fan speed only if required, because the spatial distribution of temperature and humidity will also be reduced.

Technical data refers to 100% fan speed.

For the control range of temperature and relative humidity, see the temperature / humidity diagrams chap. 18).



With set-point type “Limit”, adapt the safety controller (chap. 13.2) or the temperature safety device class 3.3 (option, chap.13.3) always when you changed the temperature set-point. Set the safety controller set-point or the set-point of temperature safety device class 3.3 (option) by approx. 2 °C to 5 °C above the controller temperature set-point.

Recommended setting: Set-point type “Offset” with safety controller set-point 2 °C.



When operating without humidity by setting “Control off” (chap. 6.3), the humidity tolerance range function is automatically deactivated.

When operating without humidity by activated operation line “Humidity off” (chap. 8.4), set the humidity tolerance range to “0” in order to avoid tolerance range alarms (chap. 12.4).

8.1 Set-point entry through the “Setpoints” menu

 Press the **Setpoint setting** icon to access the “Setpoint” setting menu from Normal display.

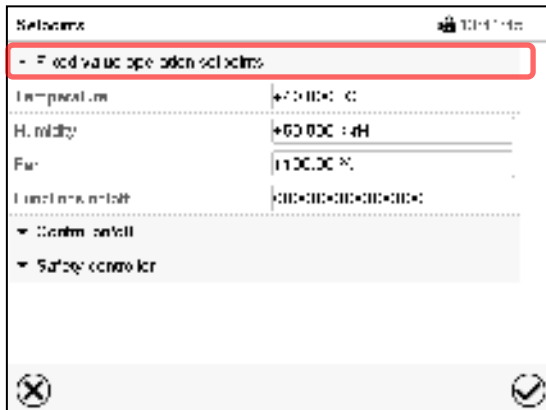

“Setpoints” menu with KBF P / KBF P-UL and KBWF



“Setpoints” menu with KBF LQC / KBF LQC-UL

Select “Fixed value operation setpoints” to access the individual parameters.

- Select the field “Temperature” and enter the desired temperature setpoint.
Setting range: -5 °C up to 70 °C.
Confirm entry with **Confirm** icon.
- Select the field “Humidity” and enter the desired humidity setpoint.
Setting range: 0% r.h. up to 80% r.h.
Confirm entry with **Confirm** icon.
- Select the field “Fan” and enter the desired fan speed setpoint.
Setting range: 40% up to 100% fan speed.
Confirm entry with **Confirm** icon.

KBF LQC / KBF LQC-UL only:

- Select the field “UVA Dose” and enter the desired target dose.
Setting range: 0.0 Wh/m² up to 99999 Wh/m².
Confirm entry with **Confirm** icon.
- Select the field “VIS Dose” and enter the desired target dose.
Setting range: 0.0 MLUXh up to 99999 MLUXh.
Confirm entry with **Confirm** icon.

 When entering a value outside the setting range, the message: “Value outside of limits! (Min: xxx, Max: xxx)” appears (xxx is a wildcard for the limits of the respective parameter). Press the **Confirm** icon and repeat the entry with a correct value.

After completing the settings, press the **Confirm** icon to take over the entries and exit the menu, **or** press the **Close** icon to exit the menu without taking over the entries.

8.2 Direct setpoint entry via Normal display

Alternatively you can also enter the setpoints directly via Normal display.

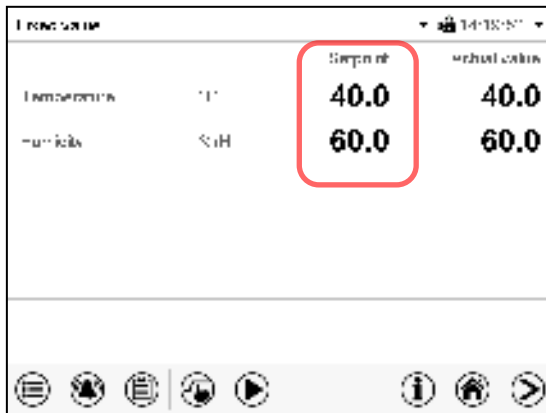

Normal display with KBF P / KBF P-UL and KBWF.



Normal display with KBF LQC / KBF LQC-UL.

Select the setpoint you want to change.



Example: "Temperature" entry menu.
Enter the desired setpoint and confirm entry with **Confirm** icon.

8.3 Automatic correction of the actual value when turning on or off the illumination

The chambers have been adjusted for operation with maximum illumination. Since the illumination creates a heat input in the chamber, this is considered automatically when operating without illumination.

This can be recognized when turning on or off the illumination by a change of the actual temperature and humidity values, which subsequently will equilibrate again to the set-points.

8.4 Light commutation and special controller functions via operation lines



Press the **Setpoint setting** icon to access the “Setpoint” setting menu from Normal display.

You can define the switching state of up to 16 operation lines (control contacts). They are used to activate / deactivate special controller functions.

- Operation line “Humidity off” serves to turn off the humidity.
- Operation line “Idle mode” activates / deactivates the operating mode “Idle mode” (chap. 5.4).
- *KBF P / KBF P-UL, KBF LQC / KBF LQC-UL*: Operation line “Light VIS” serves to turn on/off the cool white fluorescent tubes
- *KBF P / KBF P-UL, KBF LQC / KBF LQC-UL*: Operation line “Light UVA” serves to turn on/off the BINDER Synergy Light fluorescent tubes
- *KBWF*: Operation lines “Light level 1” and “Light level 2” serve to turn on/off the fluorescent tubes
- *KBF LQC / KBF LQC-UL*: Operation line “LQC On” serves to turn on/off the light integration function.
- *KBF LQC / KBF LQC-UL*: Operation line “LQC reset VIS” serves to reset to zero the integrated VIS values once in a time.
- *KBF LQC / KBF LQC-UL*: Operation line “LQC reset UVA” serves to reset to zero the integrated UVA values once in a time.

The other operation lines are without function.

Use the “Setpoints” menu to configure the operation lines.



“Setpoints” menu.

Select the field “Functions on/off”.

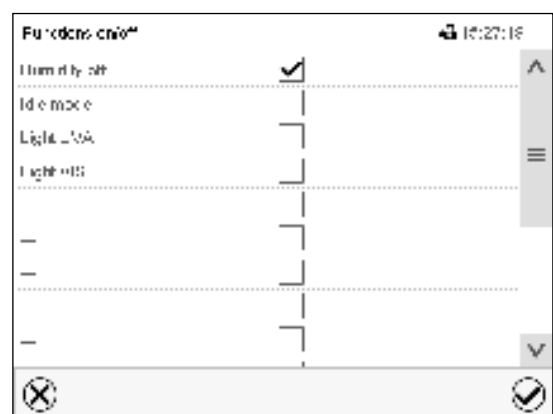

“Functions on/off” entry menu with KBF P / KBF P-UL

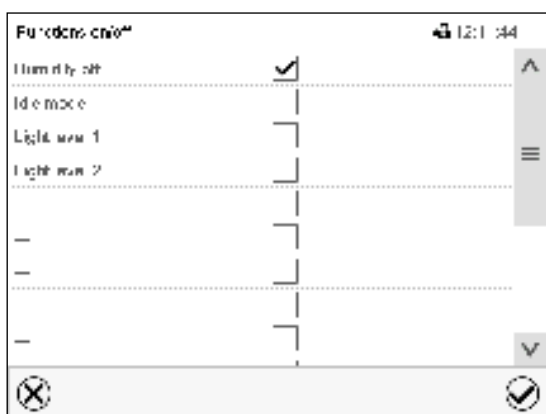

“Functions on/off” entry menu with KBWF

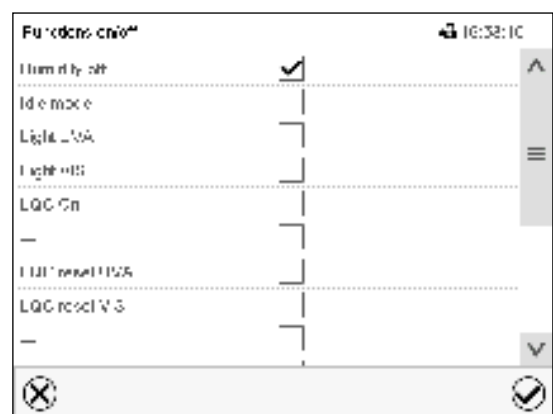

“Functions on/off” entry menu with KBF LQC / KBF LQC-UL.

Mark / unmark the checkbox to activate / deactivate the desired function and press the **Confirm** icon.

Activated operation line: switching status "1" (On)

Deactivated operation line: switching status "0" (Off)

The operation lines count from right to left.

Example:

Activated operation line "Humidity off" = 0000000000000001

Deactivated operation line "Humidity off" = 0000000000000000

9. Timer program: stopwatch function

During an entered duration the controller constantly equilibrates to the setpoints entered in Fixed value operation mode (temperature, humidity, fan speed, configuration of the operation lines). This duration can be entered as a "Timer program". During the program runtime, any setpoint changes do not become effective; the controller equilibrates to the values which were active during program start.

9.1 Starting a timer program

 In Normal display press the **Program start** icon to access the "Program start" menu.

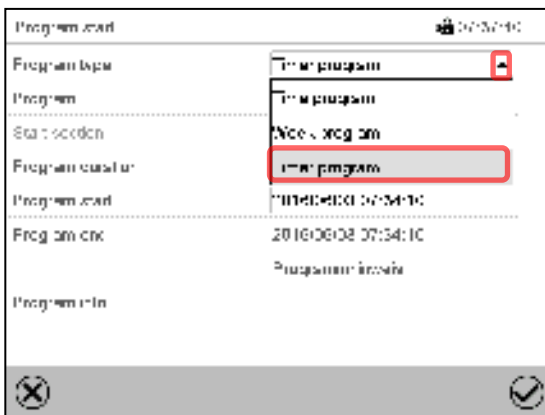

"Program start" menu

- In the field "Program type" select "Timer program".
- Select the field "Program duration" and enter the desired program duration. Press the **Confirm** icon.
- Select the field "Program start" and enter the desired start time of the program in the "Program start" entry menu. Press the **Confirm** icon. The program delay time until program start begins.



Normal display.

Information on the bottom of the screen indicates the currently running program and the time already passed. The grey bar shows how much time of the whole time is elapsed.

9.1.1 Performance during program delay time

During the configured program delay time until program start, the controller equilibrates to the current setpoints of Fixed value operation mode. Modifications of these setpoints are possible but become effective only after the timer program is finished. When the configured moment for program start is reached, the program delay time ends and the program starts running. The controller equilibrates to the values which had been active during program start



9.2 Stopping a running timer program

9.2.1 Pausing a running timer program

	Press the Program pause icon to interrupt the program.
---	---

The program is paused. The program runtime stops running down, the time display flashes.

There are the following options:

	Press the Program start icon to continue the program
	Press the Cancelling icon to cancel the program

9.2.2 Cancelling a running timer program

	Press the Program cancelling icon to cancel the program.
---	---

A confirmation prompt is displayed. Press the **Confirm** icon to confirm that the program shall really be cancelled.

After confirming the message the controller changes to Fixed value operation mode. Temperature and humidity will then equilibrate to the setpoints of Fixed value operation mode.

9.3 Performance after the end of the program

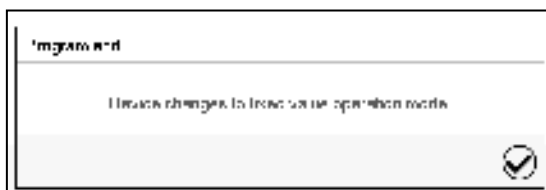

After the end of the program the message “Device changes to fixed value operation mode” appears on the screen.

Press the **Confirm** icon.

After confirming the message the controller changes to Fixed value operation mode. Temperature and humidity will then equilibrate to the setpoints of Fixed value operation mode.

10. Time programs

The MB2 program controller permits programming time programs with real-time reference. It offers 25 program memory positions with up to 100 program sections each.

For each program section you can enter a temperature set-point, a humidity set-point, fan speed, section duration, type of temperature and humidity transition (ramp or step) and the tolerance range.

KBF LQC / KBF LQC-UL: By accordingly programming the operation lines, light integration is possible (chap. 10.7.3).

 If the safety controller has been set to “limit” mode, check the setting of the safety controller when changing the temperature set-point, (chap. 13.2).

 Reduce the fan speed only if required, because the spatial distribution of temperature and humidity will also be reduced.
Technical data refers to 100% fan speed.

Programming remains saved in case of a power failure or after turning off the unit.

Path: [Main menu](#) > [Programs](#) > [Time program](#)

10.1 Starting an existing time program

 In Normal display press the **Program start** icon to access the “Program start” menu.



“Program start” menu

- In the field “Program type” select the setting “Time program”.
- In the field “Program” select the desired program.
- Select the field “Program start” and enter the desired program start time in the “Program start” entry menu. Press the **Confirm** icon. The program delay time until program start begins.

The program end is adapted automatically depending on the entered program duration.

After completing the settings, press the **Confirm** icon to take over the entries and exit the menu. The program starts running.

If instead you press the **Close** icon to exit the menu without taking over the entries, the program will not start.

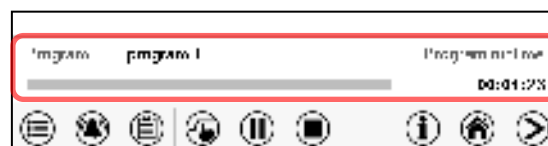

Normal display. Information on the bottom of the screen indicates the currently running program and the time already passed. The grey bar shows how much time of the whole time is elapsed. If program duration has been set to infinite, the grey bar is not displayed.

10.1.1 Performance during program delay time

During the configured program delay time until program start, the controller equilibrates to the current setpoints of Fixed value operation mode. Modifications of these setpoints are effective. When the configured moment for program start is reached, the program delay time ends and the program starts running.

10.2 Stopping a running time program

10.2.1 Pausing a running time program

	Press the Program pause icon to interrupt the program..
---	--

The program is paused. The program runtime stops running down, the time display flashes.

There are the following options:

	Press the Program start icon to continue the program
---	---

	Press the Cancelling icon to cancel the program
---	--

10.2.2 Cancelling a running time program

	Press the Program cancelling icon to cancel the program.
---	---

A confirmation prompt is displayed. Press the **Confirm** icon to confirm that the program shall really be cancelled.

After confirming the message, the controller changes to Fixed value operation mode. Temperature and humidity will then equilibrate to the setpoints of Fixed value operation mode.

10.3 Performance after the end of the program

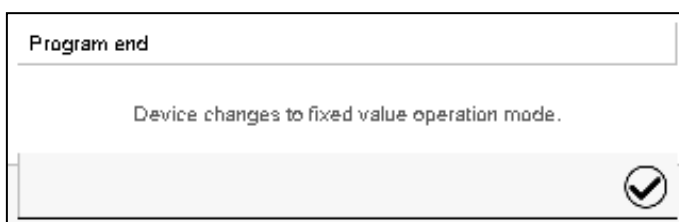

After the end of the program the message "Device changes to fixed value operation mode" appears on the screen.

Press the **Confirm** icon.

As long as the message has not been confirmed, the setpoint of the last program section remains effective. Program the last section as desired. If e.g. heating, refrigeration, humidification and dehumidification shall turn off, activate operation line "Idle mode" in the last program section.

After confirming the message the controller changes to Fixed value operation mode. Temperature and humidity will then equilibrate to the setpoints of Fixed value operation mode.

10.4 Creating a new time program

Path: [Main menu](#) > [Programs](#) > [Time program](#)



“Time program” menu:
overview of the existing programs.
Select an empty program place.

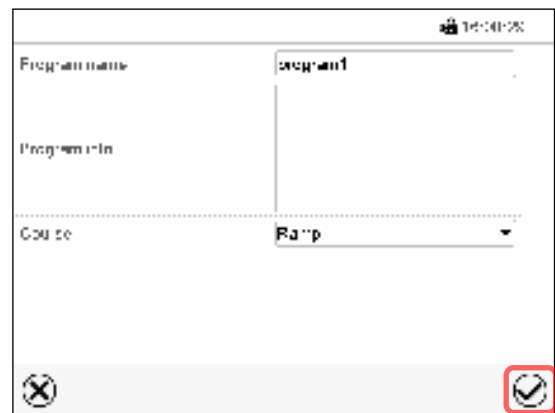

Enter the program name and, if desired, additional program information in the corresponding fields.

Select the set-point course “Ramp” or “Step” (chap. 11.6.1).

Press the **Confirm** icon.

The program view opens (chap. 10.5).

10.5 Program editor: program management

Path: [Main menu](#) > [Programs](#) > [Time program](#)

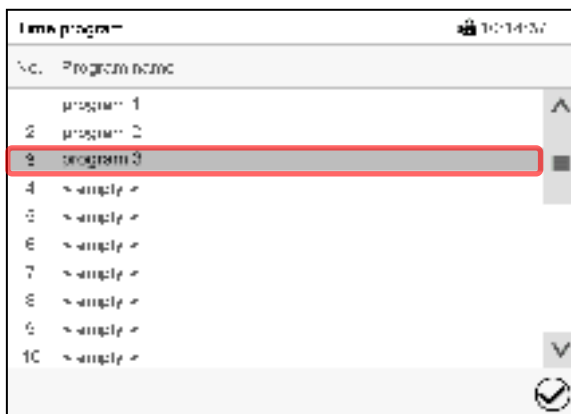

“Time program” menu:
overview of the existing programs.
Select an existing program (example: program 3) or create a new program (chap. 10.4).
The program view opens.

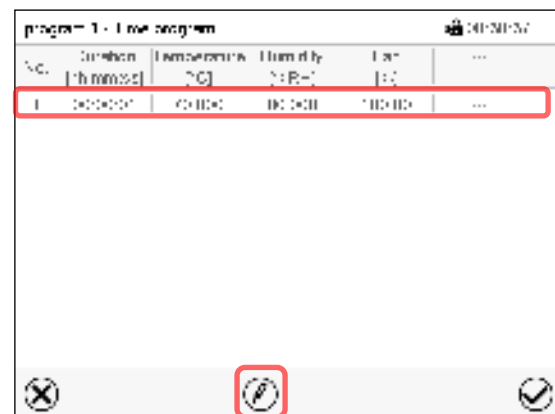

Example: Display with KBF P / KBF P-UL and KBWF

Program view (example: program 3).

If a new program has been created, there is just one program section.

There are the following options:

- ① Select a program section to open the section editor (chap. 10.6)
- ② Press the **Edit** icon to open the program editor



Program editor: “Edit program” menu

Select the desired function and press the **Confirm** icon.

The program editor offers following options:

- Change the program name
- Copy program
- Replace program: Replacing an new or an existing program with the copied program. This menu point is visible only after a program has been copied.
- Delete program
- Create new section

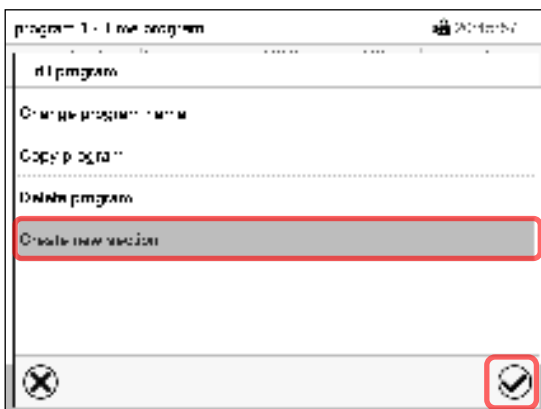

To add a new section, select “Create new section” and press the **Confirm** icon.

The program view opens.

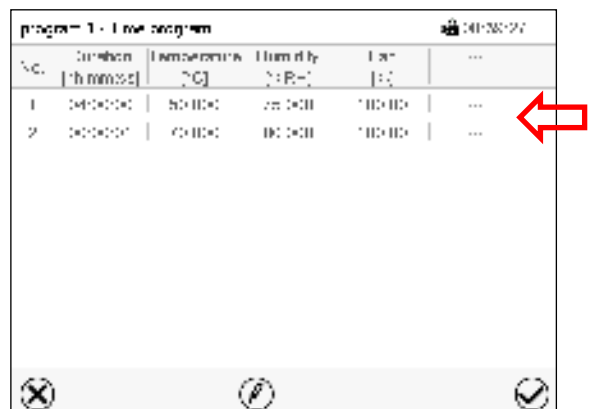

Example: Display with KBF P / KBF P-UL and KBWF

Program view.

A new section is always added at the very bottom (example: section 2).

10.5.1 Deleting a time program

Path: [Main menu](#) > [Programs](#) > [Time program](#)

In the “Time program” menu select the program to be deleted. The program view opens.

In the **program view** press the **Edit** icon to open the program editor

In the **program editor** select “Delete program” and press the **Confirm** icon.

The program is deleted. The controller returns to the program view.

10.6 Section editor: section management

Path: **Main menu > Programs > Time program**

Select the desired program.

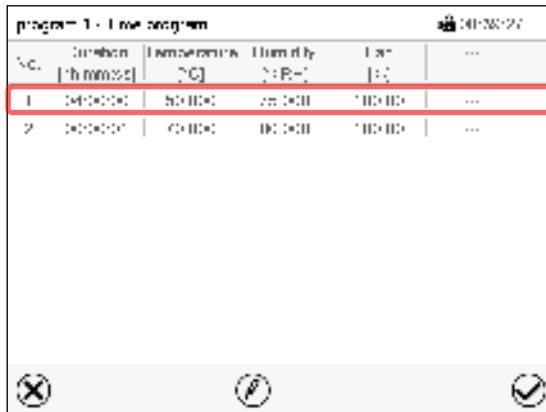

Example: Display with KBF P / KBF P-UL and KBWF

Program view.

Select the desired program section (example: section 1)

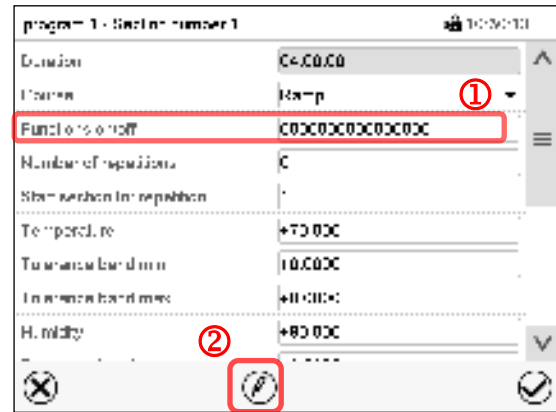

Section view (example: section 1).

There are the following options:

- ① Select a parameter to enter or modify the according value (chap. 10.7)
- ② Press the **Edit** icon to open the program editor

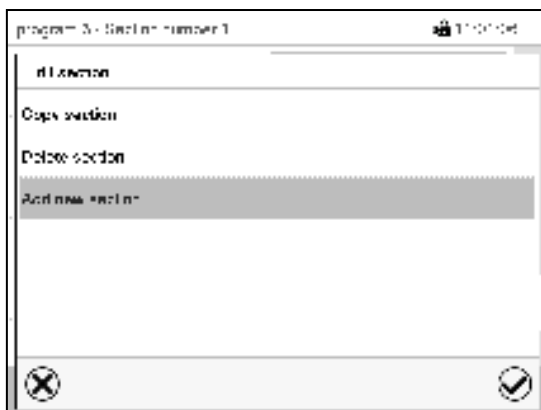

Section editor: "Edit section" menu

Select the desired function and press the **Confirm** icon.

The section editor offers following options:

- Copy section
- Replace section: Replacing an existing section with the copied section. This menu point is visible only after a section has been copied.
- Insert section: Adding the copied section. This menu point is visible only after a section has been copied.
- Delete section
- Add new section

10.6.1 Add a new program section

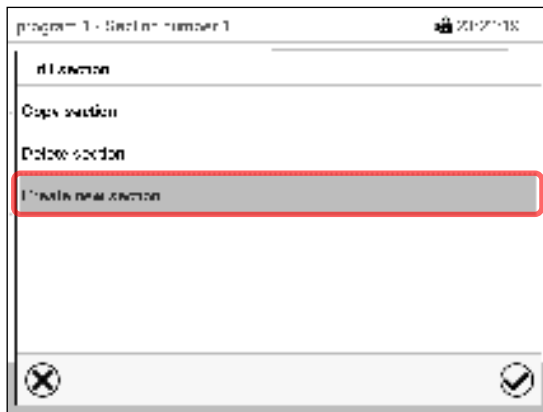

Section editor: “Edit section” menu.

Select “Create new section” and press the **Confirm** icon.

Then select whether to insert the new section before or after the current section.

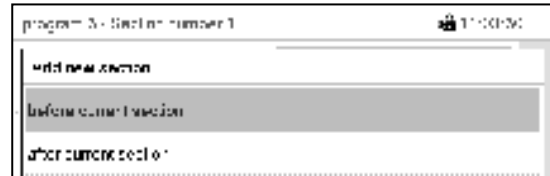

Press the **Confirm** icon. The new section opens.

10.6.2 Copy and insert or replace a program section

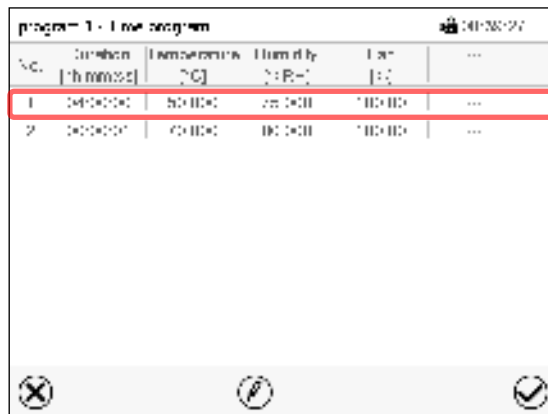

Program view (example: Display with KBF P / KBF P-UL and KBWF)

Select the program section to be copied (example: section 1)

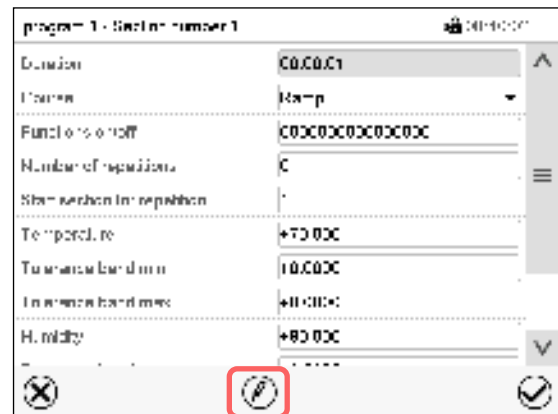

Section view (example: section 1).

Press the **Edit** icon to open the section editor.

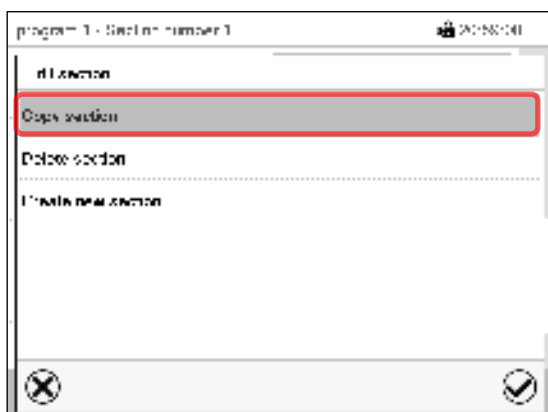

Section editor: “Edit section” menu

Select “Copy section” and press the **Confirm** icon.

The current section (example: section 1) is copied. The controller returns to the section view.

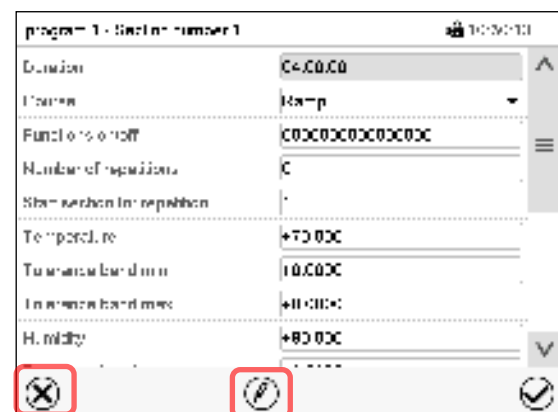

Section view (example: section 1).

Press the **Close** icon to change to the program view, if you want to select another section to be replaced or before or after which the copied section shall be inserted...

or

Press the **Edit** icon to open the section editor if you want the current section to be replaced or the copied section to be inserted before or after it

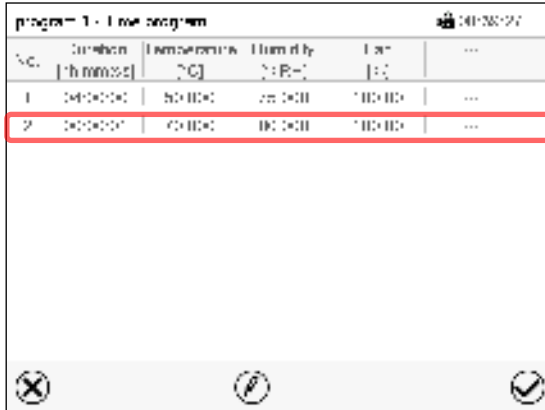

Program view (example: Display with KBF P / KBF P-UL and KBWF)

Select the section to be replaced or before or after which the copied section shall be inserted (example: section 2) and press the **Confirm** icon.

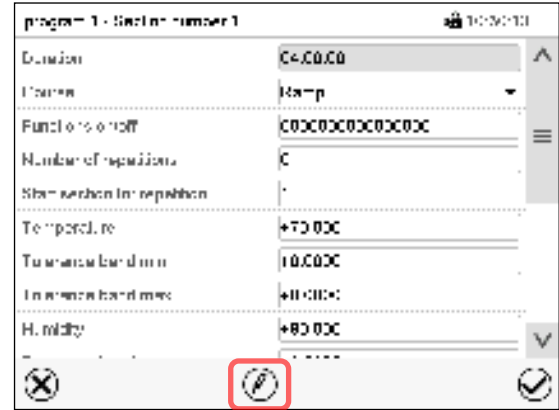

Section view (example: section 1).

Press the **Edit** icon to open the section editor

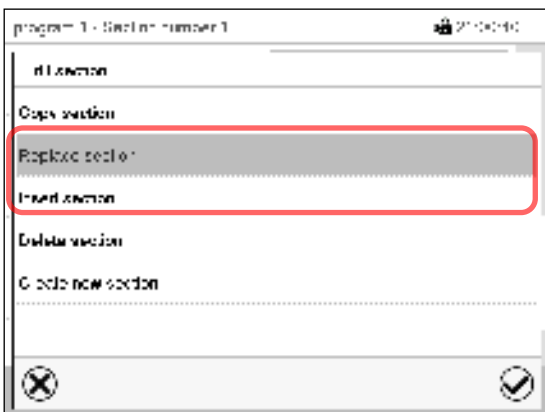

Section editor: "Edit section" menu

Select "Replace section" to replace the selected section with the copied section

or

Select "Insert section" to additionally add the copied section.

In this case select whether to insert it before or after the selected section.

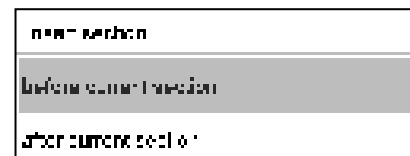

Press the **Confirm** icon

10.6.3 Deleting a program section

In the **program view** select the program section to be deleted. The section view opens.



In the **section view** press the **Edit** icon to open the section editor



In the **section editor** select "Delete section" and press the **Confirm** icon.



The section is deleted. The controller returns to the section view.

10.7 Value entry for a program section

Path: [Main menu](#) > [Programs](#) > [Time program](#)

Select the desired program and section.

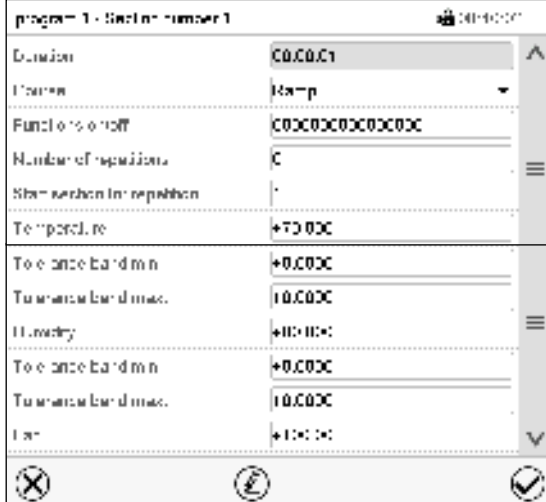
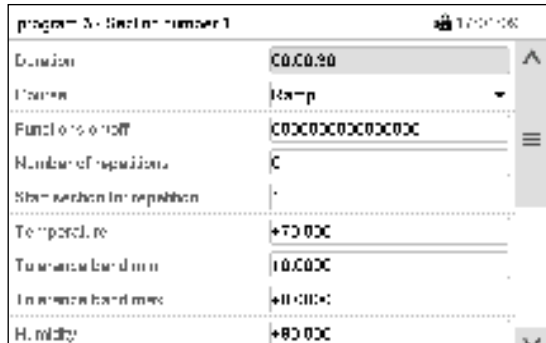
The section view gives access to all parameters of a program section. You can enter or modify the values.

	<table border="1"> <tbody> <tr><td>Program name and section number</td></tr> <tr><td>Section duration</td></tr> <tr><td>Type of setpoint transition: ramp or step</td></tr> <tr><td>Operation lines</td></tr> <tr><td>Repeating one or several sections within a program</td></tr> <tr><td>Temperature setpoint</td></tr> <tr><td>Temperature tolerance range: minimum and maximum</td></tr> <tr><td>Humidity setpoint</td></tr> <tr><td>Humidity tolerance range: minimum and maximum</td></tr> <tr><td>Fan speed</td></tr> </tbody> </table>	Program name and section number	Section duration	Type of setpoint transition: ramp or step	Operation lines	Repeating one or several sections within a program	Temperature setpoint	Temperature tolerance range: minimum and maximum	Humidity setpoint	Humidity tolerance range: minimum and maximum	Fan speed				
Program name and section number															
Section duration															
Type of setpoint transition: ramp or step															
Operation lines															
Repeating one or several sections within a program															
Temperature setpoint															
Temperature tolerance range: minimum and maximum															
Humidity setpoint															
Humidity tolerance range: minimum and maximum															
Fan speed															
<p>Display with KBF P / KBF P-UL and KBWF</p>															
	<table border="1"> <tbody> <tr><td>Program name and section number</td></tr> <tr><td>Section duration</td></tr> <tr><td>Type of setpoint transition: ramp or step</td></tr> <tr><td>Operation lines</td></tr> <tr><td>Repeating one or several sections within a program</td></tr> <tr><td>Temperature setpoint</td></tr> <tr><td>Temperature tolerance range: minimum and maximum</td></tr> <tr><td>Humidity setpoint</td></tr> <tr><td>Humidity tolerance range: minimum and maximum</td></tr> <tr><td>Fan speed</td></tr> <tr><td>UVA setpoint</td></tr> <tr><td>UVA dose: tolerance range: minimum and maximum</td></tr> <tr><td>VIS setpoint</td></tr> <tr><td>VIS dose: tolerance range: minimum and maximum</td></tr> </tbody> </table>	Program name and section number	Section duration	Type of setpoint transition: ramp or step	Operation lines	Repeating one or several sections within a program	Temperature setpoint	Temperature tolerance range: minimum and maximum	Humidity setpoint	Humidity tolerance range: minimum and maximum	Fan speed	UVA setpoint	UVA dose: tolerance range: minimum and maximum	VIS setpoint	VIS dose: tolerance range: minimum and maximum
Program name and section number															
Section duration															
Type of setpoint transition: ramp or step															
Operation lines															
Repeating one or several sections within a program															
Temperature setpoint															
Temperature tolerance range: minimum and maximum															
Humidity setpoint															
Humidity tolerance range: minimum and maximum															
Fan speed															
UVA setpoint															
UVA dose: tolerance range: minimum and maximum															
VIS setpoint															
VIS dose: tolerance range: minimum and maximum															
															
<p>Display with KBF LQC / KBF LQC-UL</p>															

The setting and control ranges for the individual parameters are the same as for “Fixed value” operating mode (chap. 8).

10.7.1 Section duration

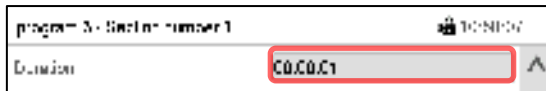

Section view (partial view).

Select the field "Duration" indicating the time.



"Duration" entry menu.

Enter the desired section duration with the arrow keys and press the **Confirm** icon.

Setting range: 0 up to 99 hours 59 min 59 sec.

10.7.2 Set-point ramp and set-point step

You can define the type of temperature and humidity transitions for each individual program section.

"Ramp" mode: Gradual changes of temperature and humidity

The set-point of a given program section functions as the section's start temperature. During the section's duration, the set-point gradually passes to the set-point of the subsequent program section. The actual value follows the continually changing set-point.

If the last program section is in "ramp" mode and the setpoint shall change within this section, then you must program an additional section (with the shortest possible section duration) to provide the target temperature of the last program section. Otherwise, the setpoint would remain constant during the section's duration.

Programming in the "ramp" mode allows all kinds of temperature and humidity transitions:

- Gradual changes of temperature and humidity
The setpoint changes its value gradually during the entered section duration. The actual value follows the continually moving set-point at any time.
- Program sections with constant temperature and humidity
The setpoints (initial values) of two subsequent program sections are identical; so the temperature and humidity remain constant during the entire duration of the first program section.
- Sudden changes of temperature and humidity
Steps can be programmed in ramp mode as temperature or humidity changes (ramps) that occur during a very short interval. If the duration of this transitional program section is very short (minimum entry 1 sec), the temperature or humidity change will proceed rapidly within the minimum amount of time.

"Step" mode: Sudden changes of temperature and humidity

The set-point of any program section functions as the section's target value. At the start of the program section, the unit heats up or cools down and humidifies/dehumidifies the chamber with the maximum speed to reach the entered value; and then it holds it for the remaining section time. Therefore the set-point temperature remains constant for the section's duration. These changes occur rapidly within the minimum amount of time (minimum entry: 1 second).

Programming in the “step” mode allows only two kinds of temperature and humidity transitions:

- Programming gradual changes of temperature and humidity (ramps) is impossible in the “step” mode
- Program sections with constant temperature and humidity

The setpoints (target values) of two subsequent program sections are identical; so the temperature and humidity remain constant during the entire duration of the first program section.

- Sudden changes of temperature and humidity

The entered setpoint of the section is reached as fast as possible and then held constant for the remaining section duration.

Selecting the setting “Ramp” or “Step”

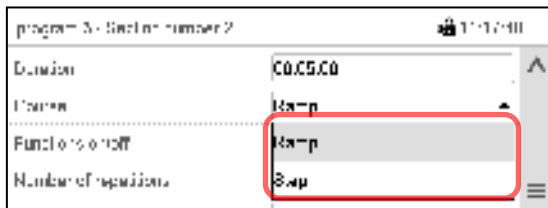

Section view (partial view).

In the field “Course” select the desired setting “Ramp” or “Step”.

“Ramp” and “Step” mode example (representation of a temperature course)

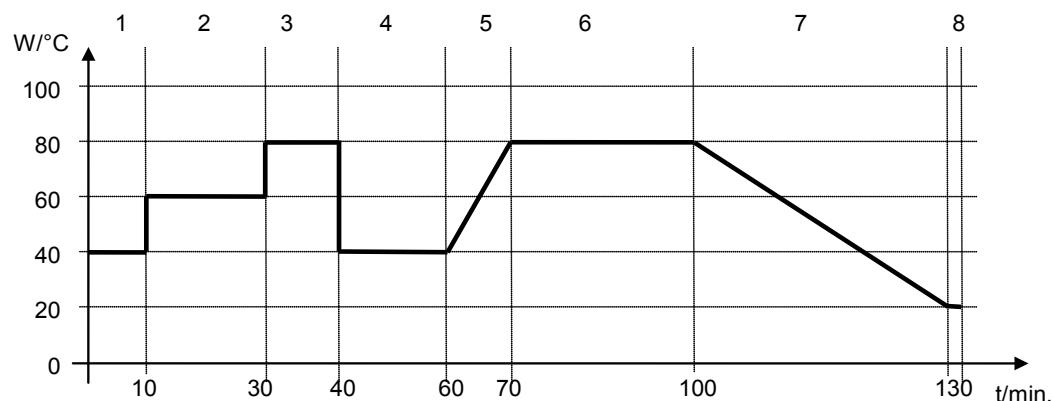

Corresponding program table

Section No.	Duration [hh:mm:ss]	Temperature [°C]	Humidity [% rH]	Fan [%]	Ramp or Step
1	00:10:00	40.0	xxxx	xxxx	Step
2	00:20:00	60.0	xxxx	xxxx	Step
3	00:10:00	80.0	xxxx	xxxx	Step
4	00:20:00	40.0	xxxx	xxxx	Step
5	00:10:00	40.0	xxxx	xxxx	Ramp
6	00:30:00	80.0	xxxx	xxxx	Ramp
7	00:30:00	80.0	xxxx	xxxx	Ramp
8	00:00:01	20.0	xxxx	xxxx	Ramp

10.7.3 Light commutation and special controller functions via operation lines

You can define the switching state of up to 16 operation lines (control contacts). They are used to activate / deactivate special controller functions.

- Operation line “Humidity off” serves to turn off the humidity.
- Operation line “Idle mode” activates / deactivates the operating mode “Idle mode” (chap. 5.4).
- *KBF P / KBF P-UL, KBF LQC / KBF LQC-UL*: Operation line “Light VIS” serves to turn on/off the cool white fluorescent tubes
- *KBF P / KBF P-UL, KBF LQC / KBF LQC-UL*: Operation line “Light UVA” serves to turn on/off the BINDER Synergy Light fluorescent tubes
- *KBWF*: Operation lines “Light level 1” and “Light level 2” serve to turn on/off the fluorescent tubes
- *KBF LQC / KBF LQC-UL*: Operation line “LQC On” serves to turn on/off the light integration function.
- *KBF LQC / KBF LQC-UL*: Operation line “LQC reset VIS” serves to reset to zero the integrated VIS values once in a time.
- *KBF LQC / KBF LQC-UL*: Operation line “LQC reset UVA” serves to reset to zero the integrated UVA values once in a time.

The other operation lines are without function.

Use the setting “Functions on/off” to configure the operation lines.

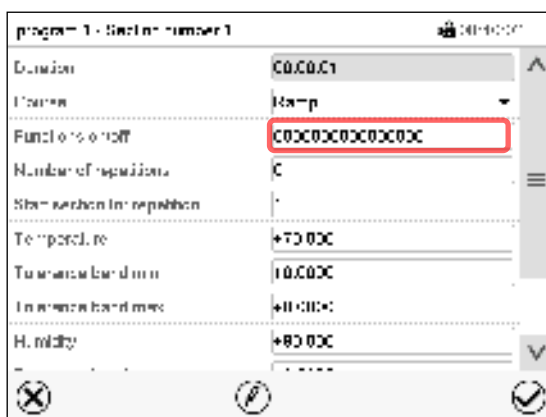

Section view.

Select the field “Functions on/off”.

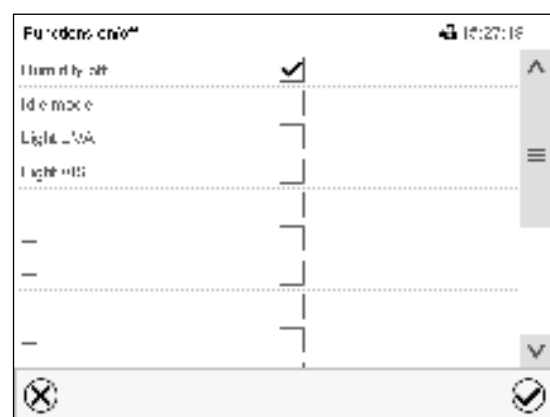

“Functions on/off” entry menu with KBF P / KBF P-UL

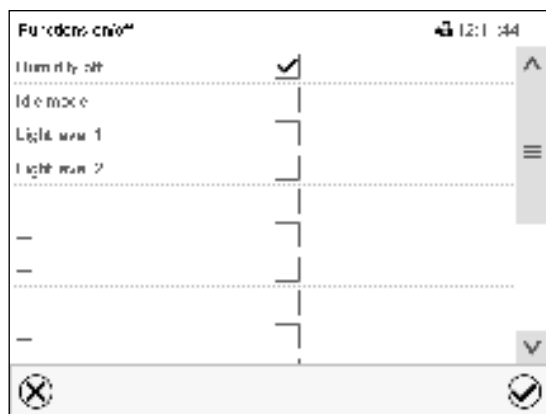

“Functions on/off” entry menu with KBWF

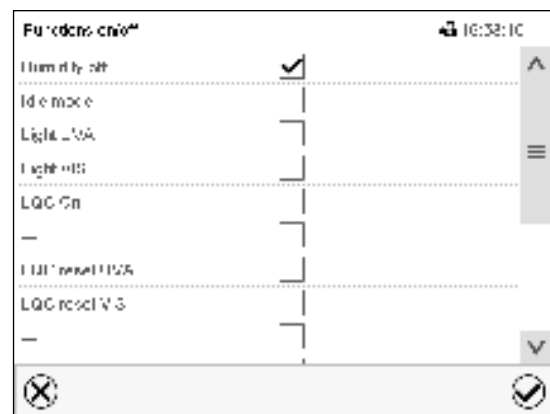

“Functions on/off” entry menu with KBF LQC / KBF LQC-UL

Mark / unmark the checkbox of the desired function to activate / deactivate it and press the **Confirm** icon.
The controller returns to the section view.

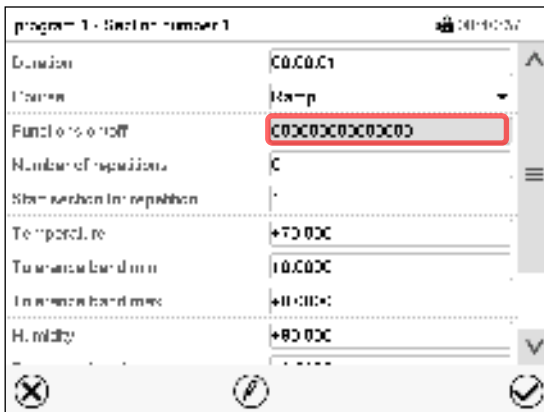

Section view indicating the operation lines.

Activated operation line: switching status “1” (On)

Deactivated operation line: switching status “0” (Off)

The operation lines count from right to left.

Example:

Activated operation line “Humidity off” = 0000000000000001

Deactivated operation line “Humidity off” = 0000000000000000

10.7.4 Setpoint entry

- Select the field “Temperature” and enter the desired temperature setpoint.
Setting range: -5 °C up to 70 °C.
Confirm entry with **Confirm** icon. The controller returns to the section view.
- Select the field “Humidity” and enter the desired humidity setpoint.
Setting range: 0% r.H. up to 80% r.H.
Confirm entry with **Confirm** icon. The controller returns to the section view.
- Select the field “Fan” and enter the desired fan speed setpoint.
Setting range: 40% up to 100% fan speed.
Confirm entry with **Confirm** icon. The controller returns to the section view.

KBF LQC / KBF LQC-UL only:

- Select the field “UVA Dose” and enter the desired target dose.
Setting range: 0.0 Wh/m² up to 99999 Wh/m².
Confirm entry with **Confirm** icon. The controller returns to the section view.
- Select the field “VIS Dose” and enter the desired target dose.
Setting range: 0.0 MLUXh up to 99999 MLUXh.
Confirm entry with **Confirm** icon. The controller returns to the section view.

10.7.5 Tolerance ranges

For temperature and humidity and, with KBF LQC / KBF LQC-UL, for the VIS and UVA dose, you can specify a tolerance range for each program section with different values for the tolerance minimum and maximum. When the actual value exceeds the given threshold, the program is interrupted. This is indicated on the display (see below). When the actual temperature is situated again within the entered tolerance limits, the program automatically continues. Therefore, the duration of the program may be extended due to the programming of tolerances.



Programming of tolerances may extend program duration.

An entry of “-99999” for the tolerance minimum means “minus infinite” and an entry of “999999” for the tolerance maximum means “plus infinite”. Entry of these values will never lead to program interruption. The entry of “0” for the tolerance minimum and/or maximum deactivates the respective tolerance function.

When requesting rapid value transitions, we recommend not programming tolerance values in order to enable the maximum heating-up, cooling-down, humidification or dehumidification speed.

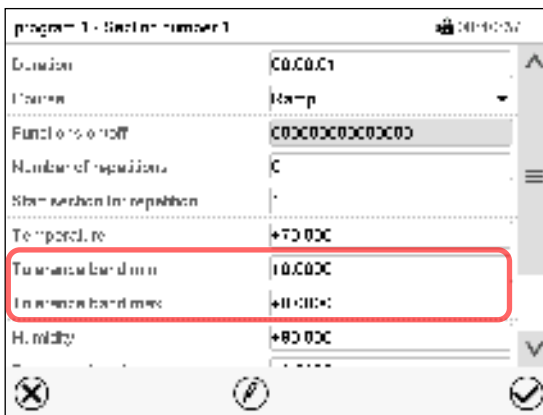

Section view, showing the temperature tolerance band

- Select the field “Tolerance band min” and enter the desired lower tolerance band value. Setting range: -99999 to 99999. Confirm entry with **Confirm** icon. The controller returns to the section view.
- Select the field “Tolerance band max” and enter the desired upper tolerance band value. Setting range: -99999 to 99999. Confirm entry with **Confirm** icon. The controller returns to the section view.

Set the tolerance ranges for other parameters accordingly, if desired.

If one of those actual values for which a tolerance range has been specified lies outside this program tolerance range the whole program course is interrupted. During this program interruption time the controller equilibrates to the set-points of the current section.

The screen header indicates “Program pause (tolerance band)”. The program runtime indication flashes and does not proceed any further.

When the corresponding actual value is back within the entered program tolerance range, the program continues automatically.

10.7.6 Repeating one or several sections within a time program

You can repeat several subsequent sections together. It is not possible to define the start section the same time also as the target section, therefore you cannot repeat a single individual section.

Enter the desired number of repetitions in the field „Number of repetitions“ and the number of the section to start the repetition cycle with in the field “Start section for repetition” To have sections repeated infinitely, enter the number of repetitions as “-1”.

The selected sections are repeated as many times as selected. Then the program continues.

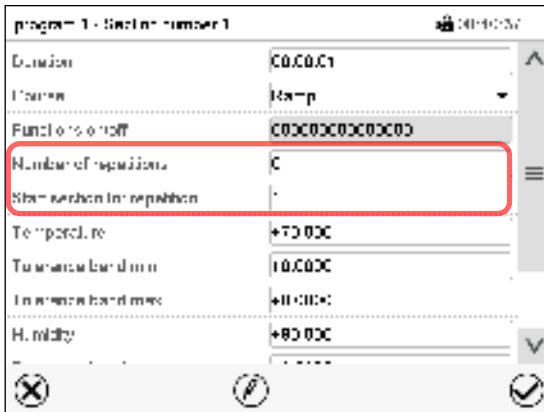

Section view, showing the repetition function

- Select the field “Number of repetitions” and enter the desired number of repetitions. Setting range: 1 to 99, and -1 for infinite. Confirm entry with **Confirm** icon. The controller returns to the section view.
- Select the field “Start section for repetition” and enter the section number, at which the repetition should start. Setting range: 1 up to the section before the currently selected section. Confirm entry with **Confirm** icon. The controller returns to the section view.

10.7.7 Saving the time program

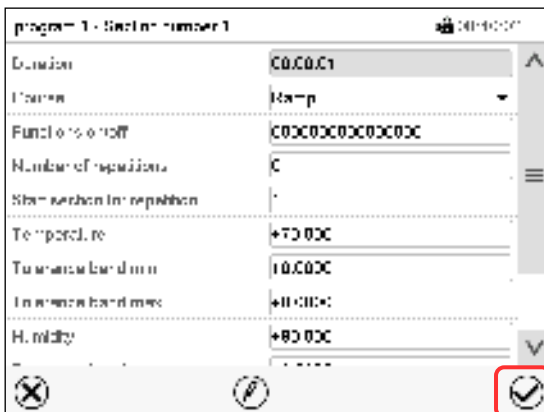

Section view.

After the all desired values of the program section have been configured, press the **Confirm** icon to take over the programming. The controller changes to the program view.

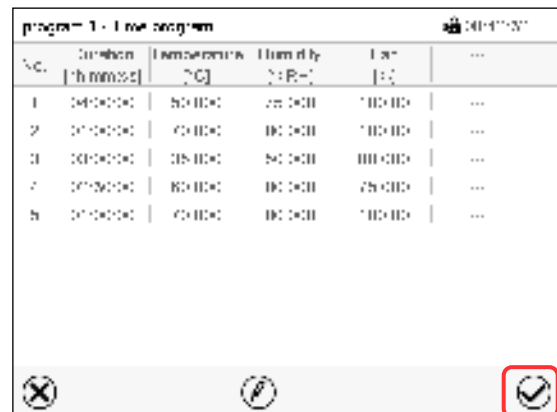

Example: Display with KBF P / KBF P-UL and KBWF

Program view.

Press the **Confirm** icon to take over the programming.

The controller changes to the Normal display.



To save the programming it is absolutely required to press the **Confirm** icon. Otherwise all settings will be lost! There is no confirmation prompt!

11. Week programs

The MB2 program controller permits programming week programs with real-time reference. It offers 5 week program places in total with up to 100 shift points for each week program.

Path: [Main menu](#) > [Programs](#) > [Week program](#)

KBf LQC / KBf LQC-UL: By programming the operation lines accordingly, light integration is possible (chap 11.6.5).

11.1 Starting an existing week program

 In Normal display press the **Program start** icon to access the “Program start” menu.



“Program start” menu.

- In the field “Program type” select the setting “Week program”.
- In the field “Program” select the desired program.
- There are no further settings available in the “Program start” menu for week programs, as they are needed only for time programs.

After completing the settings, press the **Confirm** icon to take over the entries and exit the menu. The program starts running.

If instead you press the **Close** icon to exit the menu without taking over the entries, the program will not start.

After starting the week program, the previously entered week program setpoints are active and will be equilibrated according to the current time.



Information on the bottom of the screen indicates the currently running program.

11.2 Cancelling a running week program

 Press the **Program cancelling** icon to cancel the program.

A confirmation prompt is displayed. Press the **Confirm** icon to confirm that the program shall really be cancelled.

After confirming the message the controller changes to Fixed value operation mode. Temperature and humidity will then equilibrate to the setpoints of Fixed value operation mode.

11.3 Creating a new week program

Path: *Main menu > Programs > Week program*

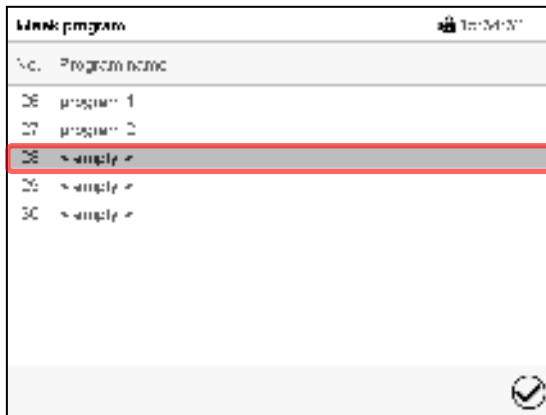

“Week program” menu:
overview of the existing programs.
Select an empty program place.

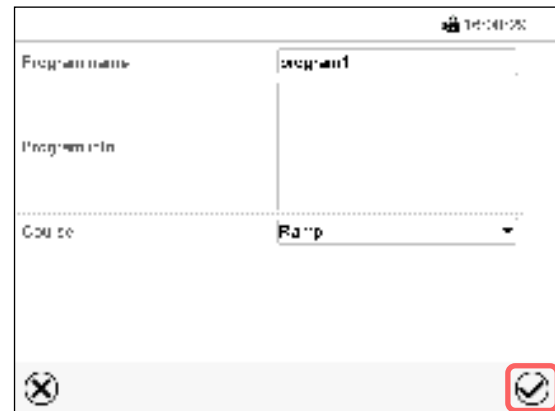

Enter the program name and, if desired, additional program information in the corresponding fields.

Select the set-point course “Ramp” or “Step” (chap. 11.6.1).

Press the **Confirm** icon.

The program view opens.



Program view.

For the first section no weekday is specified.
Therefore the section is first marked in red and cannot be saved.

11.4 Program editor: program management

Path: [Main menu](#) > [Programs](#) > [Week program](#)



“Week program” menu:
overview of the existing programs.
Select an existing program (example: program 1).

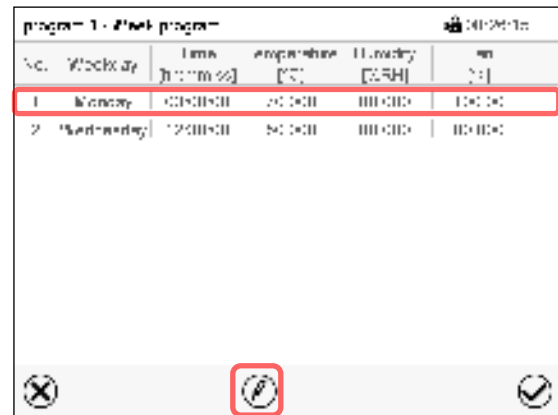

Program view (example: program 1).
If a new program has been created, there is just one program section.

There are the following options:

- ① Select a program section to open the section editor (chap. 11.5)
- ② Press the **Edit** icon to open the program editor

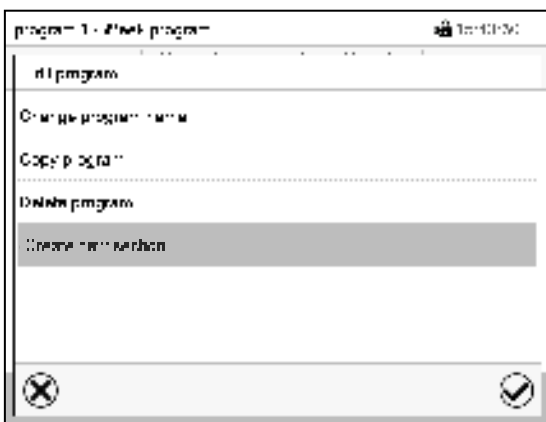

Program editor: “Edit program” menu.
Select the desired function and press the **Confirm** icon.

The program editor offers following options:

- Change program name. This menu also offers to configure the ramp / step mode setting (chap. 11.6.1).
- Copy program
- Replace program: Replacing an new or an existing program with the copied program. This menu point is visible only after a section has been copied.
- Delete program
- Create new section

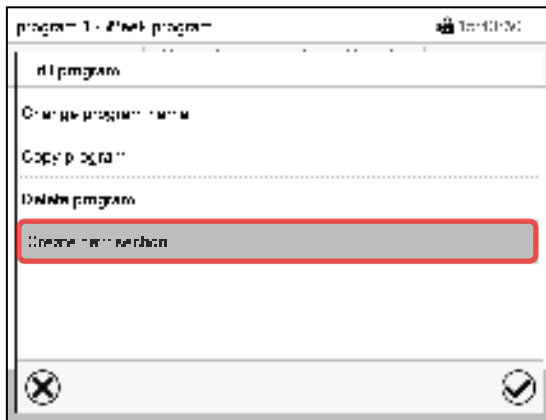

To add a new section, select “Create new section” and press the **Confirm** icon.
The program view opens.



No.	Weekday	Time [hh:mm:ss]	expirishine [h]	Fluency [L/RH]	no [1]
1	Monday	00:00:00	20:00	00:00	100:00
2	Monday	00:00:00	20:00	00:00	100:00

Program view.

With a new section no weekday is specified. Therefore the section is first marked in red and cannot be saved.

A new section is always added at the very bottom (example: section 2). When the section start is specified the sections are automatically arranged in the correct chronological order.

11.4.1 Deleting a week program

Path: [Main menu](#) > [Programs](#) > [Week program](#)

In the “Week program” menu select the program to be deleted. The program view opens.

In the **program view** press the **Edit** icon to open the program editor

In the **program editor** select “Delete program” and press the **Confirm** icon.

The program is deleted. The controller returns to the program view.

11.5 Section editor: Section management

Path: **Main menu > Programs > Week program**

Select the desired program.



Program view.

Select the desired program section (example: section 1)

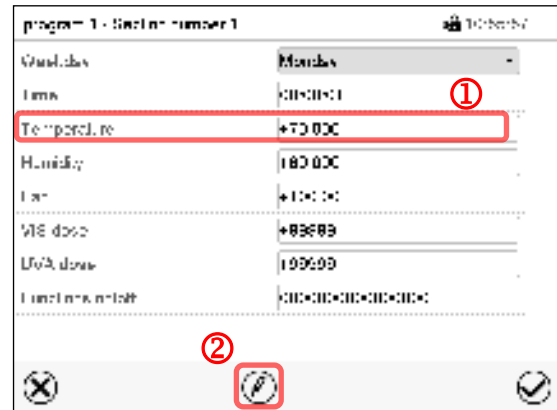

Section view (example: section 1).

There are the following options:

- ① Select a parameter to enter or modify the according value (chap. 11.6)
- ② Press the **Edit** icon to open the program editor

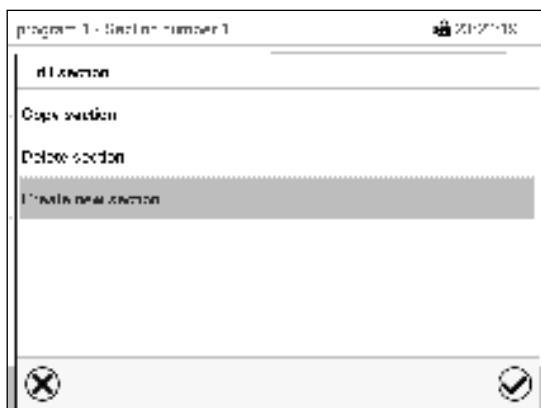

Section editor: "Edit section" menu

Select the desired function and press the **Confirm** icon.

The section editor offers following options:

- Copy section
- Replace section: Replacing an existing section with the copied section. This menu point is visible only after a section has been copied.
- Insert section: Adding the copied section. This menu point is visible only after a section has been copied.
- Delete section
- Create new section

11.5.1 Add a new program section

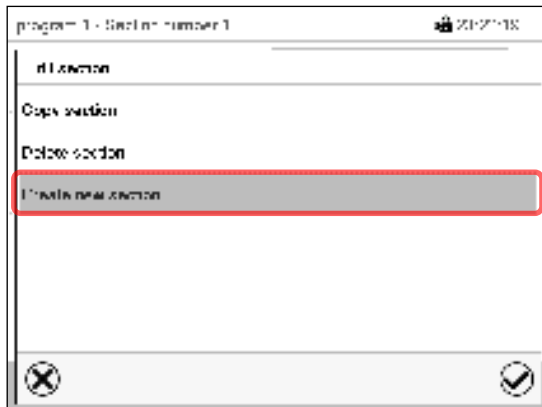

Section editor: “Edit section” menu.

Select “Create new section” and press the **Confirm** icon.

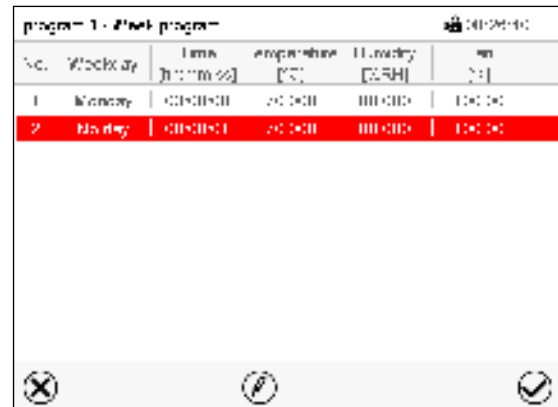

Program view.

With a new section no weekday is specified. Therefore the section is first marked in red and cannot be saved.

A new section is always added at the very bottom (example: section 2). When the section start is specified the sections are automatically arranged in the correct chronological order.



11.5.2 Copy and insert or replace a program section

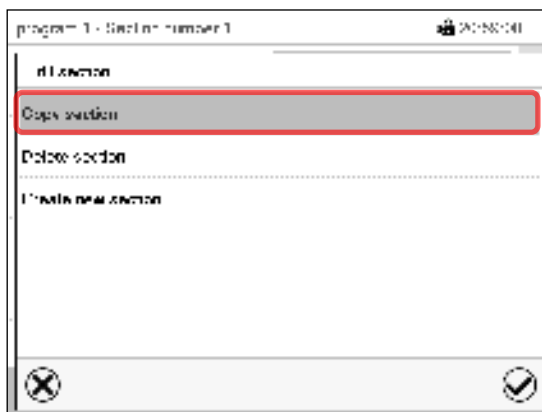

Section editor: “Edit section” menu

Select “Copy section” and press the **Confirm** icon.

The current section (example: section 1) is copied.

The controller returns to the program view.



Program view

Select the section to be replaced or before or after which the copied section shall be inserted (example: section 2).

Press the **Confirm** icon

The controller returns to the section editor



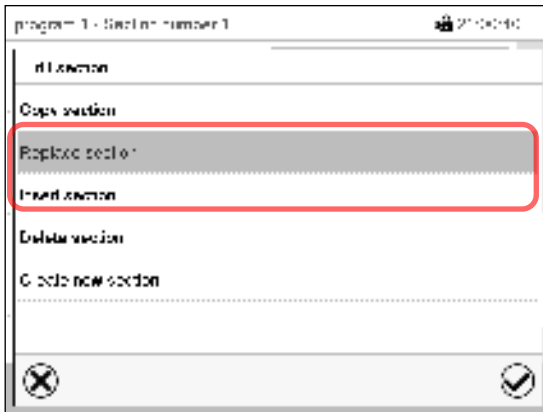

Section editor: "Edit section" menu

Select "Replace section" to replace the selected section with the copied section

or

Select "Insert section" to additionally add the copied section.

Press the **Confirm** icon.

If you selected "Insert section" the sections are automatically arranged in the correct chronological order.

11.5.3 Deleting a program section

In the **program view** select the program section to be deleted. The section view opens.



In the **section view** press the **Edit** icon to open the section editor



In the **section editor** select "Delete section" and press the **Confirm** icon.

The section is deleted. The controller returns to the section view.

11.6 Value entry for a program section

Path: [Main menu](#) > [Programs](#) > [Week program](#)

Select the desired program and section.

The setting and control ranges for the individual parameters are the same as for "Fixed value" operating mode (chap. 8).

11.6.1 Set-point ramp and set-point step modes

The explanation of the settings "Ramp" or "Step" is given in chap. 10.7.2.

You can define the type of temperature and humidity transitions for the entire week program.

Select the desired program and press the **Edit** icon to open the program editor. In the program editor select the "Change program name" function and press the **Confirm** icon.

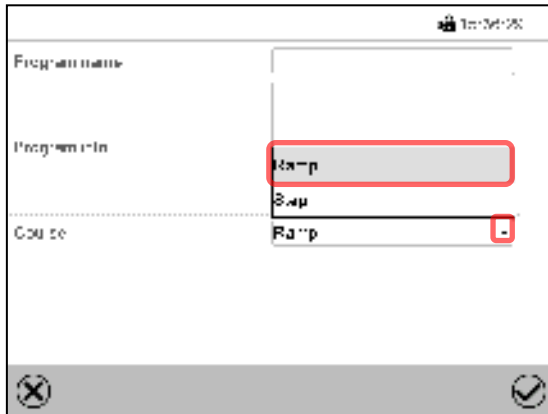

“Change program name” menu.

In the field “Course” select the desired setting “Ramp” or “Step” and press the **Confirm** icon.

11.6.2 Weekday

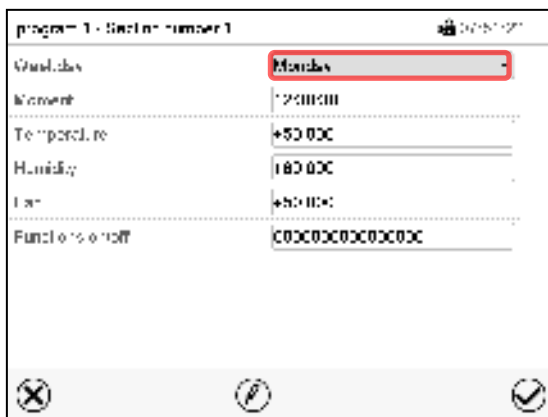

Section view.

In the field “Weekday” select the desired weekday.

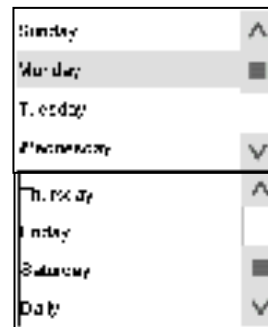

With “Daily” selected, this section will run every day at the same time.

11.6.3 Start time



Section view.

Select the field “Moment”.

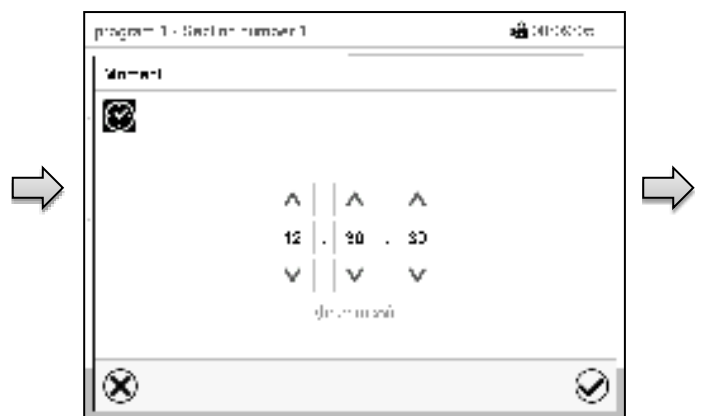

Entry menu “Moment”.

Select with the arrow keys the desired start moment of the section and press the **Confirm** icon.

11.6.4 Setpoint entry

- Select the field “Temperature” and enter the desired temperature setpoint.
Setting range: -5 °C up to 70 °C.
Confirm entry with **Confirm** icon. The controller returns to the section view
- Select the field “Humidity” and enter the desired humidity setpoint.
Setting range: 0% r.h. up to 80% r.h.
Confirm entry with **Confirm** icon. The controller returns to the section view
- Select the field “Fan” and enter the desired fan speed setpoint.
Setting range: 40% up to 100% fan speed.
Confirm entry with **Confirm** icon. The controller returns to the section view

KBF LQC / KBF LQC-UL only:

- Select the field “UVA Dose” and enter the desired target dose.
Setting range: 0.0 Wh/m² up to 99999 Wh/m².
Confirm entry with **Confirm** icon. The controller returns to the section view
- Select the field “VIS Dose” and enter the desired target dose.
Setting range: 0.0 MLUXh up to 99999 MLUXh.
Confirm entry with **Confirm** icon. The controller returns to the section view

11.6.5 Light commutation and special controller functions via operation lines

You can define the switching state of up to 16 operation lines (control contacts). They are used to activate / deactivate special controller functions.

- Operation line “Humidity off” serves to turn off the humidity.
- Operation line “Idle mode” activates / deactivates the operating mode “Idle mode” (chap. 5.4).
- *KBF P / KBF P-UL, KBF LQC / KBF LQC-UL*: Operation line “Light VIS” serves to turn on/off the cool white fluorescent tubes
- *KBF P / KBF P-UL, KBF LQC / KBF LQC-UL*: Operation line “Light UVA” serves to turn on/off the BINDER Synergy Light fluorescent tubes
- *KBWF*: Operation lines “Light level 1” and “Light level 2” serve to turn on/off the fluorescent tubes
- *KBF LQC / KBF LQC-UL*: Operation line “LQC On” serves to turn on/off the light integration function.
- *KBF LQC / KBF LQC-UL*: Operation line “LQC reset VIS” serves to reset to zero the integrated VIS values once in a time.
- *KBF LQC / KBF LQC-UL*: Operation line “LQC reset UVA” serves to reset to zero the integrated UVA values once in a time.

The other operation lines are without function.

Select the desired program and section. You can set the operation lines in the “Functions on/off” field.

For details please refer to chap. 10.7.3.

12. Notification and alarm functions

12.1 Notification and alarm messages overview

12.1.1 Notifications

Notifications are indicated by **information icons** displayed in the screen header in Normal display

An information icon serves as an indication of a certain condition.

If this condition persists, in some cases an alarm will be triggered after a fix or configurable interval. As long as the condition persists, the information icon therefore continues to be displayed also in state of alarm. If during alarm the conditions ends, e.g., if during a tolerance range alarm the actual value returns to within the tolerance range, the information icon disappears, whereas the alarm will continue until manual acknowledgement.



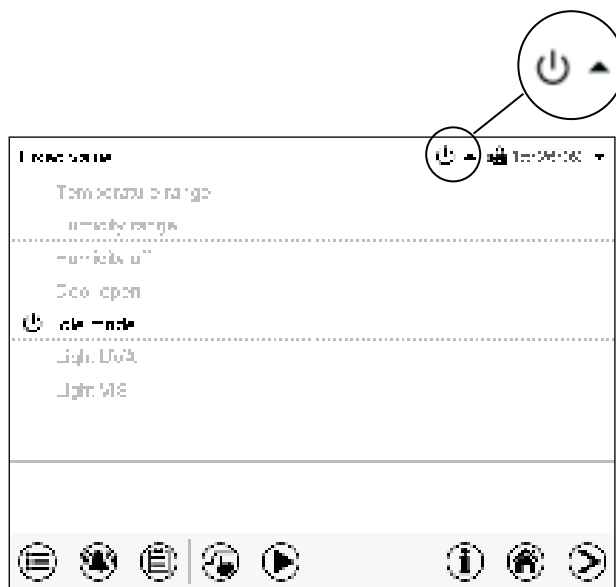

Press the flash icon next to the information icon to access the corresponding text information.





Normal display showing the text information.

Example: Display with KBF P



The currently valid information texts are highlighted in black (example: "Idle mode")









Condition	Information icon	Text information	Start after condition occurred
The controller is in Idle mode (chap. 5.4).		"Idle mode"	immediately
The current actual temperature value is outside the tolerance range (chap. 12.4)		"Temperature range"	immediately
The current actual humidity value is outside the tolerance range (chap. 12.4)		"Humidity range"	immediately
The humidification / dehumidification system is turned off (via operation line and/or by setting "Control on/off") or Temperature setpoint below 0 °C or above 95 °C		"Humidity off"	immediately
Chamber door open		"Door open"	immediately

Condition	Information icon	Text information	Start after condition occurred
<i>KBF P / KBF P-UL, KBF LQC / KBF LQC-UL</i> : VIS light turned on (operation line "Light VIS" activated)	VIS	"Light VIS"	immediately
<i>KBF P / KBF P-UL, KBF LQC / KBF LQC-UL</i> : UVA light turned on (operation line "Light UVA" activated)	UVA	"Light UVA"	immediately
<i>KBF LQC / KBF LQC-UL</i> : Light integration activated (operation line "LQC On" activated)	LQC	"LQC On"	immediately
<i>KBWF</i> : Light level 1 (40% illumination) turned on (operation line "Light level 1" activated)		"Light level 1"	immediately
<i>KBWF</i> : Light level 2 (60 % illumination) turned on (operation line "Light level 2" activated)		"Light level 2"	immediately

Notifications are not shown in the event list.

12.1.2 Messages when reaching a dose target value – KBF LQC / KBF LQC-UL

Fixed value		LQC VIS UVA   16:48:07 	
		Setpoint	Actual value
Temperature	°C	20.0	20.0
Humidity	%RH	60.0	60.0
VIS dose	Wh/m ²	1.00	0.00
UVA dose	MLUXh	1.00	0.00

When the VIS target dose is reached the corresponding line in Normal Display is highlighted in green, and the message "VIS dose reached" is displayed in the event list.

When the UVA target dose is reached the corresponding line in Normal Display is highlighted in green, and the message "UVA dose reached" is displayed in the event list.

As soon as the second target dose is reached as well, in addition the alarm message "VIS and UVA doses reached" is displayed, and a buzzer sounds. The alarm can be acknowledged on the controller. The alarm message is displayed in the event list.

12.1.3 Alarm messages

Condition	Alarm message	Start after condition occurred	Zero-voltage relay alarm output (option)
The current actual temperature value is outside the tolerance range (chap. 12.4)	"Temperature range	after configurable time	time as alarm start
The current actual humidity value is outside the tolerance range (chap. 12.4)	"Humidity range	after configurable time	time as alarm start
Open chamber door	"Door open	after 5 minutes	----
Power failure	---	----	immediately
Exceeded setpoint of the safety controller class 3.1	"Safety controller	immediately	----
Exceeded maximum or minimum temperature (option temperature safety device class 3.3)	"Temp. safety device	immediately	----
Temperature sensor defective	e.g. "----" or "<-<-< " or ">->->"	immediately	----
Safety controller temperature sensor defective	Safety controller sensor	immediately	----
<i>KBF LQC / KBF LQC-UL</i> : Both dose target values VIS and UVA reached	"VIS and UVA doses reached"	immediately	immediately
At least one light sensor plugged in: Maximum temperature limited to 60 °C	"Light sensor 60 °C"	immediately	----

Alarm messages are displayed in the list of active alarms until acknowledging them. They are also shown in the event list.

12.1.4 Messages concerning the humidity system

Condition and measures	Message	Start after condition occurred
The humidity module is defective. Contact BINDER service	"Humidity system"	immediately
The humidity module cannot fill up. <i>In case of freshwater supply via water pipe:</i> The water tap is closed, or the chamber is defective (e.g. inlet valve of humidity module). <i>In case of freshwater supply via freshwater can (option, chap. 21.9):</i> Water can is empty. Humidification is turned off. In case of refrigerating operation, the interior is strongly dehumidified. When the water supply is functional again, the humidity system restarts, or the chamber is defective.	"Freshwater supply"	immediately
The humidity module cannot empty the condensate tank. Wastewater tube obstructed. Check the length and location of the wastewater tube. If appropriate contact BINDER service.	"Wastewater"	immediately

Condition and measures	Message	Start after condition occurred
Maintenance of the humidity system is required. Contact BINDER service.	“Humidity module service”	after predefined time (approx. 1 year)

Messages concerning the humidity system are shown in the event list.

	When operating the chamber without water connection, turn off humidity control in the “set-points” menu (chap. 6.3) in order to avoid humidity alarms.
--	--

12.2 State of alarm

1. Visual indications in Normal display: alarm message, screen header flashing in red color
2. Audible alert, if the buzzer is enabled (chap. 12.5).
3. Switching the zero-voltage relay alarm output (option, chap. 21.5) to transmit the alarm e.g., to a central monitoring system.

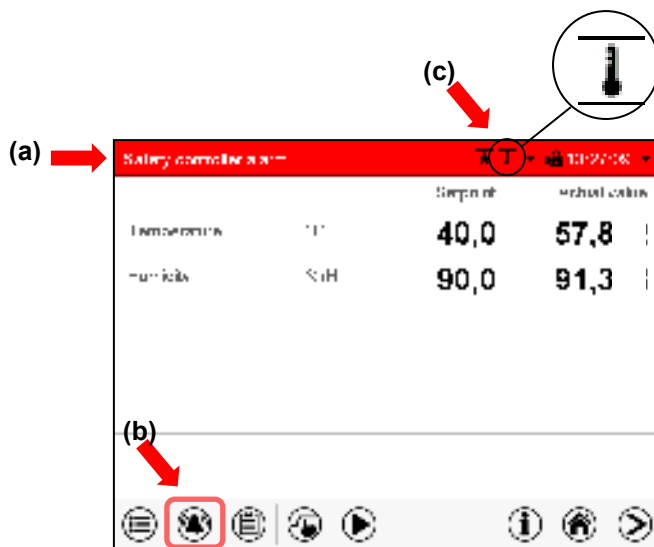

Normal display in state of alarm (example).

- (a) Screen header flashing in red color and showing the alarm message
- (b) **Alarm** icon on the bottom of the screen: change to the list of active alarms and alarm acknowledgement
- (c) If applicable, information icon in the screen header. Indication of a certain condition

12.3 Resetting an alarm, list of active alarms



Normal display in state of alarm (example).

Press the **Alarm** icon



List of active alarms.

Press the **Reset alarm** icon.

Pressing the **Reset alarm** icon mutes the buzzer for all active alarms. The icon then disappears.

- Acknowledging while the alarm condition persists: Only the buzzer turns off. The visual alarm indication remains on the controller display. The alarm remains in the list of active alarms.

When the alarm condition has ended, the visual alarm indication is automatically cleared. The alarm is then no longer in the list of active alarms.

- Acknowledging after the alarm condition has ended: The buzzer and the visual alarm indication are reset together. The alarm is then no longer in the list of active alarms.
- The zero-voltage relay alarm output resets together with the alarm.

12.4 Tolerance range settings

In this menu you can set the deviation between the actual value and setpoint which shall cause a tolerance range alarm.

This function only activates after the set-point has been reached once.

Path: [Main menu](#) > [Settings](#) > [Various](#)

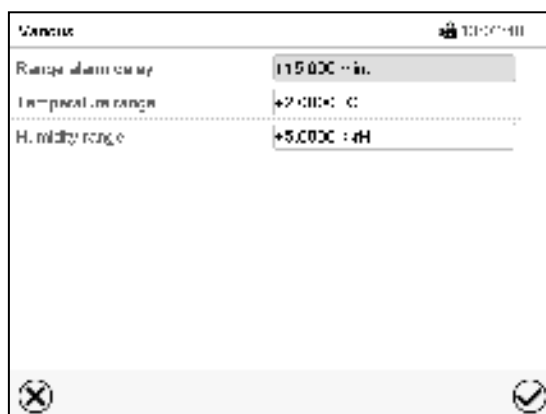



Submenu "Various".

- Select the field “Range alarm delay” and enter the time in minutes, after which the range alarm shall be triggered. Setting range: 15 min to 120 min. Confirm entry with **Confirm** icon.
- Select the field “Temperature range” and enter the desired value for the temperature range. Setting range: 2 °C to 20 °C. Confirm entry with **Confirm** icon.
- Select the field “Humidity range” and enter the desired value for the humidity range. Setting range: 5% r.h. to 20% r.h. Confirm entry with **Confirm** icon.

After completing the settings, press the **Confirm** icon to take over the entries and exit the menu, **or** press the **Close** icon to exit the menu without taking over the entries.

If there are actual values outside the tolerance range the following information icons for the corresponding parameter are displayed:

Icon	Signification	Information
	“Temperature range”	The temperature value is outside the tolerance range
	“Humidity range”	The humidity value is outside the tolerance range

If the condition persists, an alarm is triggered after the configured interval (“range alarm delay”). It is visually indicated in Normal display. If the alarm buzzer is activated (chap. 12.5) there is an audible alert. The zero-voltage relay alarm output (option, chap. 21.5) switches to transmit the alarm. The alarm is shown in the list of active alarms (chap. 12.3).

12.5 Activating / deactivating the audible alarm (alarm buzzer)

Path: [Main menu](#) > [Settings](#) > [Chamber](#)



“Chamber” submenu.

In the field “Audible alarm” select the desired setting “off” or “on” and press the **Confirm** icon.

13. Temperature safety devices

13.1 Over temperature protective device (class 1)

The chamber is equipped with an internal temperature safety device, class 1 acc. to DIN 12880:2007. It serves to protect the chamber and prevents dangerous conditions caused by major defects.

If a temperature of approx. 110 °C / 230 °F is reached, the over temperature protective device permanently turns off the chamber. The user cannot restart the device again. The protective cut-off device is located internally. Only a service specialist can replace it. Therefore, please contact an authorized service provider or BINDER Service.

13.2 Overtemperature safety controller class 3.1

The chambers are regularly equipped with an electronic overtemperature safety controller (temperature safety device class 3.1 according to DIN 12880:2007). The safety controller is functionally and electrically independent of the temperature control system. If an error occurs, it performs a regulatory function.



With option temperature safety device class 3.3 (chap. 13.3), the safety controller is **not** used. It must be set to the maximum limit value (70 °C / 158 °F).

Please observe the DGUV guidelines 213-850 on safe working in laboratories, issued by the employers' liability insurance association (for Germany).

The overtemperature safety controller serves to protect the chamber, its environment and the contents from exceeding the maximum permissible temperature. In the case of an error, it limits the temperature inside the chamber to the entered safety controller set-point. This condition (state of alarm) is indicated visually and additionally with an audible alert if the buzzer is enabled (chap. 12.5). The alarm persists until the chamber cools down below the configured safety controller setpoint.



Check the setting regularly and adjust it following changes of the set-point or charge.



The safety controller only activates after the set-point has been reached once.

13.2.1 Safety controller modes

You can select between "Limit (absolute)" and "Offset (relative)" safety controller mode

- **Limit:** Absolute maximum permitted temperature value

This setting offers high safety as a defined temperature limit will not be exceeded. It is important to adapt the safety controller set-point after each modification of the temperature set-point. Otherwise, the limit could be too high to ensure efficient protection, or, in the opposite case, it could prevent the controller from reaching an entered set-point outside the limit range.

- **Offset:** Maximum overtemperature above any active temperature set point. The maximum temperature changes internally and automatically with every set-point change.

This setting is recommended for program operation. It is important to check the safety controller set-point and safety controller mode occasionally, as it does not offer a fix, independent limit temperature value, which would never be exceeded.

Example: Desired temperature value: 40 °C, desired safety controller value: 45 °C.
Possible settings for this example:

Temperature set point	Safety controller mode	Safety controller set-point
40 °C	Limit (absolute)	45 °C
	Offset (relative)	5 °C

13.2.2 Setting the safety controller

 Press the **Setpoint setting** icon to access the “Setpoint” setting menu from Normal display.



“Setpoints” menu.

Select the field “Safety controller” to access the settings.

- In the field “Mode” select the desired setting “Limit” or “Offset”.

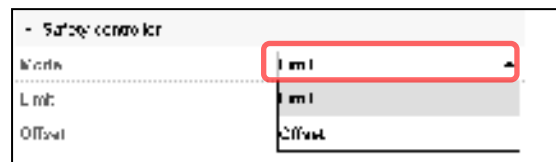

- Select the corresponding field “Limit” **or** “Offset” according to the selected mode and enter the desired safety controller setpoint. Confirm entry with **Confirm** icon.

 Regularly check the safety controller setting for set-point type “Limit” or “Offset”

- in Fixed value operating mode according to the entered set-point temperature value
- in program mode according to the highest temperature value of the selected temperature program

Set the safety controller set-point by approx. 2 °C to 5 °C above the desired temperature set-point.

After completing the settings, press the **Confirm** icon to take over the entries and exit the menu, **or** press the **Close** icon to exit the menu without taking over the entries.

13.2.3 Message and measures in the state of alarm

The state of alarm is indicated visually in Normal display by the alarm message “Safety controller alarm” and the screen header flashing in red color. If the buzzer is enabled (chap. 12.5) there is an additional audible alert (chap. 12.2). The alarm remains active until it is acknowledged on the controller and the inner temperature falls below the set safety controller setpoint. Then the heating is released again.

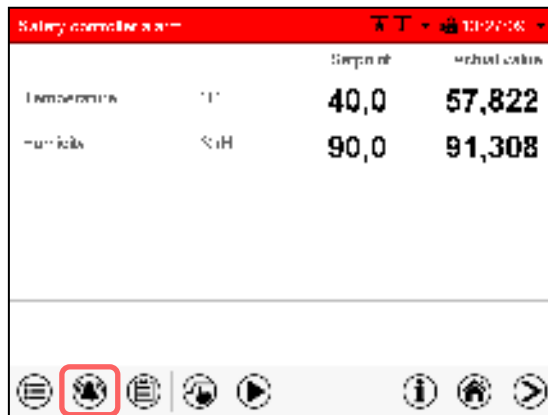

Normal display with safety controller alarm.

Press the **Alarm** icon



List of active alarms.

Press the **Reset alarm** icon.

13.2.4 Function check

Check the safety controller at appropriate intervals for its functionality. It is recommended that the authorized operating personnel should perform such a check, e.g., before starting a longer work procedure.

13.3 Temperature safety device class 3.3 (option)

With the option over/under temperature protective device (temperature safety device class 3.3 acc. to DIN 12880:2007) the chamber is equipped with two additional safety devices (class 3.1 and class 3.2). The combination of the safety devices is regarded as a safety device class 3.3.

The temperature safety device, class 3.3, serves to protect the chamber, its environment and the contents from exceeding the maximum permissible temperature. Please observe the DGUV guidelines 213-850 on safe working in laboratories, issued by the employers' liability insurance association (for Germany).

With **safety device class 3.1** a maximum value for the temperature is set that the chamber will not exceed due to the regulatory function of the safety device class 3.1. This protection against excessively high temperatures can, for example, serve to protect the chamber, its environment and the material under treatment from excess temperatures.

With **safety device class 3.2** a minimum value for the temperature is set that the chamber will not fall below due to the regulatory function of the safety device class 3.2. This protection against excessively low temperatures can, for example, serve to protect sensitive loads from under cooling.

Both safety devices are functionally and electrically independent of the temperature control system. If an error occurs, they perform regulatory function.

Safety devices class 3.1 (8) and class 3.2 (9) are located in the left lateral control panel.



With option temperature safety device class 3.3, the safety controller (chap. 13.2) must be set to the maximum limit value (70 °C / 158 °F).

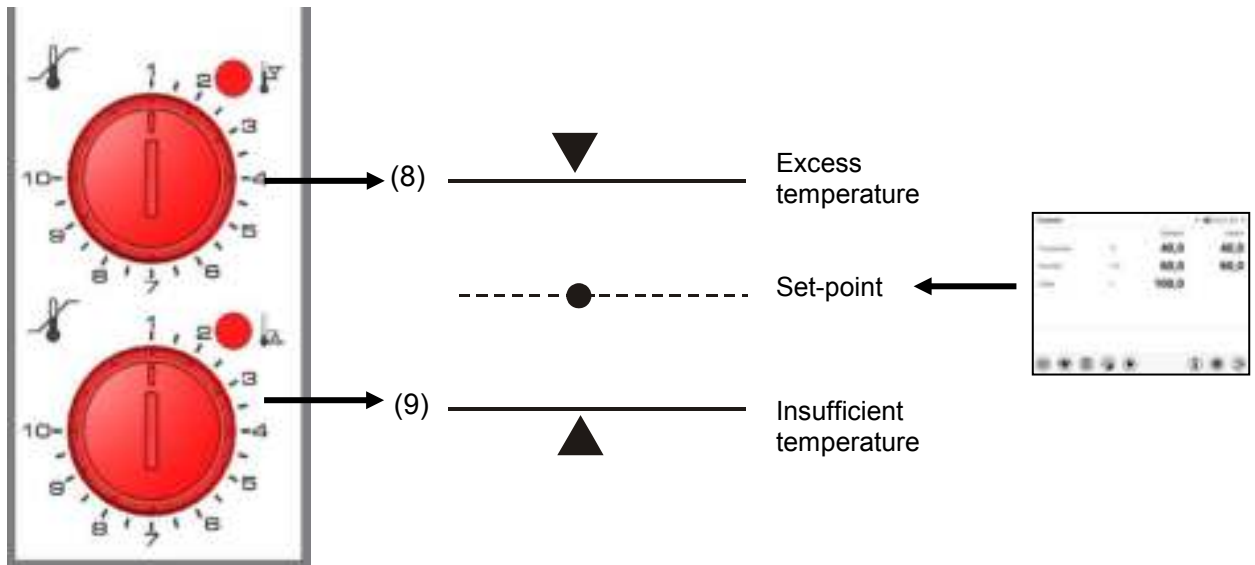
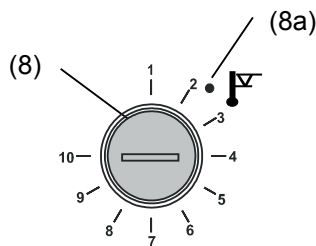

Figure 20: Temperature safety device class 3.3

13.3.1 Temperature safety device class 3.1



If you turn the control knob (8) to its end-stop (position 10), the safety device class 3.1 protects the appliance. If you set the temperature a little above the set-point, it protects the charging material.

If the safety device class 3.1 has taken over control, identifiable by the red alarm lamp (8a) lighting up, the message “Temp. safety device” on the controller will be displayed and the buzzer will sound, then proceed as follows:

- Reset the buzzer by pressing the **Reset alarm** icon on the controller
- Disconnect the chamber from the power supply
- Have an expert examine and rectify the cause of the fault.
- Start up the chamber again

Setting:

To check the response temperature of the safety device class 3.1, turn on the chamber and set the desired set point at the temperature controller.

The sections of the scale from 1 to 10 correspond to the temperature range from 0 °C / 32 °F to 120 °C / 248 °F and serve as a setting aid.

- Turn the control knob (8) of the safety device using a coin to its end-stop (position 10) (chamber protection).
- When the set point is reached, turn back the control knob (8) until its trip point (turn it counter-clockwise).
- The trip point is identifiable by the red alarm lamp (8a), the message “Temp. safety device” on the controller display, and the buzzer sounds. Reset the buzzer with the **Reset alarm** icon on the controller.
- The optimum setting for the safety device is obtained by turning the control knob clockwise by approximately two scale divisions, which shuts off the red alarm lamp (8a).

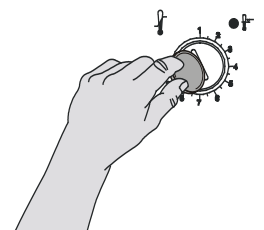

Figure 21: Setting safety device class 3.1



Check the setting regularly and adjust it following changes of the set-point or charge.

Function check:

Check the temperature safety device class 3.1 at appropriate intervals for its functionality. It is recommended that the authorized operating personnel should perform such a check, e.g., before starting a longer work procedure.

13.3.2 Temperature safety device class 3.2

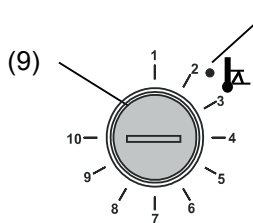

(9a) The safety device class 3.2 is equivalently set to a minimum temperature the chamber will not fall below. This protection against prohibited low temperatures can, for example, serve to protect sensitive cultures from cooling down too much.

If the control knob (9) is turned to its minimum (position 1), the safety device class 3.2 has no effect. If it is set to a temperature somewhat lower than that selected by means of the controller, it functions as a protective device for the material under treatment.

If the temperature safety device class 3.2 has assumed regulation, identifiable by the red alarm lamp (9a) lighting up, the message “Temp. safety device” on the controller display, and the buzzer sounds, please proceed as follows:

- Reset the buzzer with the **Reset alarm** icon on the controller.
- Disconnect the chamber from the power supply.
- Have an expert examine and rectify the cause of the fault.
- Start up the chamber again

Setting:

To check the response temperature of the safety device class 3.2, put the chamber into operation and set the desired set point at the temperature controller.

The sections of the scale from 1 to 10 correspond to the temperature range from $-40\text{ }^{\circ}\text{C}$ / $-40\text{ }^{\circ}\text{F}$ to $+160\text{ }^{\circ}\text{C}$ / $320\text{ }^{\circ}\text{F}$ and serves as a setting aid.

- Turn the control knob (9) of the safety device by means of a coin to position 1 (thermostat without effect).
- When the set point is reached, reset the safety device to its trip point (turn it clockwise).
- The trip point is identifiable by the red alarm lamp (9a), the message “Temp. safety device” on the controller display, and the buzzer sounds. Reset the buzzer with the **Reset alarm** icon on the controller.
- The optimum setting for the safety device is obtained by turning the control knob counter-clockwise by approximately two scale divisions, which shuts off the red alarm lamp (9a).

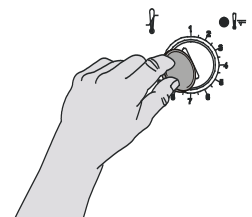

Figure 22: Setting safety device class 3.2



Check the setting regularly and adjust it following changes of set-point or charge.

Function check:

Check the temperature safety device class 3.2 at appropriate intervals for its functionality. It is recommended that the authorized operating personnel should perform such a check, e.g., before starting a longer work procedure.

14. User management

14.1 Authorization levels and password protection

The available functions depend on the current authorization level “Master”, “Service”, “Admin” or “User”.

The authorization levels are hierarchical: Every authorization includes all functions of the next lower level.

“Master” authorization level

- Highest authorization level, only for developers
- Extensive authorization for controller operation and configuration, outputs/inputs, alarm settings, parameter sets and operating ring display
- All passwords can be changed in the “log out” submenu (chap. 14.3).

“Service” authorization level

- Authorization level only for BINDER service
- Extensive authorization for controller operation and configuration, access to service data
- The passwords for “Service”, “Admin” and “User” authorization levels can be changed in the “log out” submenu (chap. 14.3).

“Admin” authorization level

- Expert authorization level, for the administrator
- Authorization for controller configuration and network settings and for operating those controller functions required for operating the chamber. Restricted access to service data.
- Password (factory setting): “2”.
- The passwords for “Admin” and “User” authorization levels can be changed in the “log out” submenu (chap. 14.3).

“User” authorization level

- Standard authorization level for the chamber operator
- Authorization for operating the controller functions required for operating the chamber.
- No authorization for controller configuration and network settings. The “Settings” and “Service” submenus of the main menu are not available.
- Password (factory setting): “1”
- The password for the “User” authorization level can be changed in the “log out” submenu (chap. 14.3).

As soon as a password has been assigned for an authorization level, the access to this level and the related controller functions are only available after log-in with the appropriate password.

If for an authorization level no password is assigned, the related controller functions of this level are available for every user without login.

If passwords have been assigned for all authorization levels, access to the controller functions is locked without login.

Operation after user login

At user login, the authorization level is selected and confirmed by entering the respective password.

Following user login, controller operation is available, recognizable by the open-lock icon in the header. The available controller functions correspond to the user's authorization level.

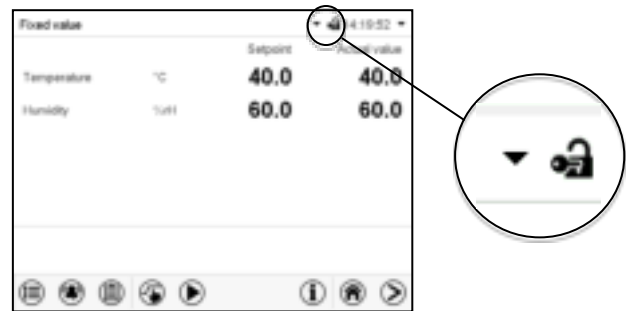

Password protection activated for all levels: operation without user login is locked

If passwords have been assigned for all authorization levels, the controller is locked without registration of a user.

As long as no user is registered, controller operation is locked, recognizable at the closed-lock icon in the header. This requires that the user management has been activated by the assignment of passwords for the individual authorization levels.

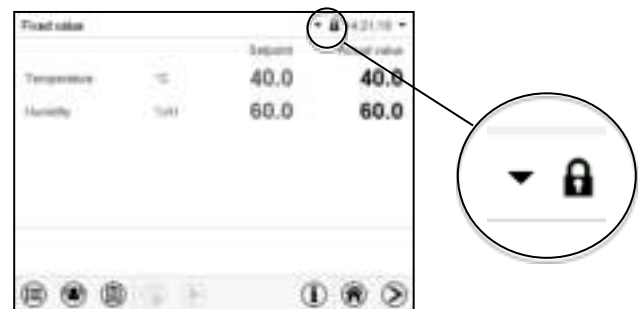

Password protection for at least one level deactivated: operation without user login is possible

If passwords have not been assigned for all authorization levels, after turning on the chamber there are those controller functions available, which correspond to the highest authorization level without password protection.

No lock icon is shown in the display header.

User login is neither required nor possible.

To activate the password protection and user login, perform new password assignment (chap. 14.5.3).

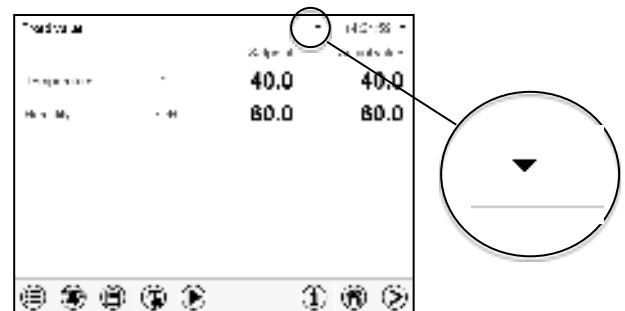

Information window

To check the authorization level of the user currently logged-in, select in Normal display the arrow far right in the display header.

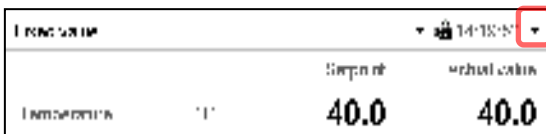

The information window shows date and time, the controller's free memory space and under "Authorization" the authorization level of the current user.

If passwords have been assigned for all authorization levels, a user without login (password entry) has no authorization. There are only viewing functions available.



Display when all authorization levels are password protected and no user has logged in:

No authorization level is displayed.

If passwords have been assigned only for some of the authorization levels, a user without login (password entry) has access to the functions of the highest authorization level without password protection.



Display when only some of the authorization levels are password protected (example: no protection for the "User" and "Admin" levels) and no user has logged in:

The user's effective authorization (due to lack of password protection) is shown.

Example: user with "Admin" authorization.

If passwords have been assigned for some or all of the authorization levels, user login (password entry) provides the authorization for the corresponding password-protected level.



Display when at least some of the authorization levels are password protected and a user has logged in.

The user's authorization (by password entry) is shown.

Example: user with "Admin" authorization.

14.2 Log in

Path: **Main menu > User > Log in**

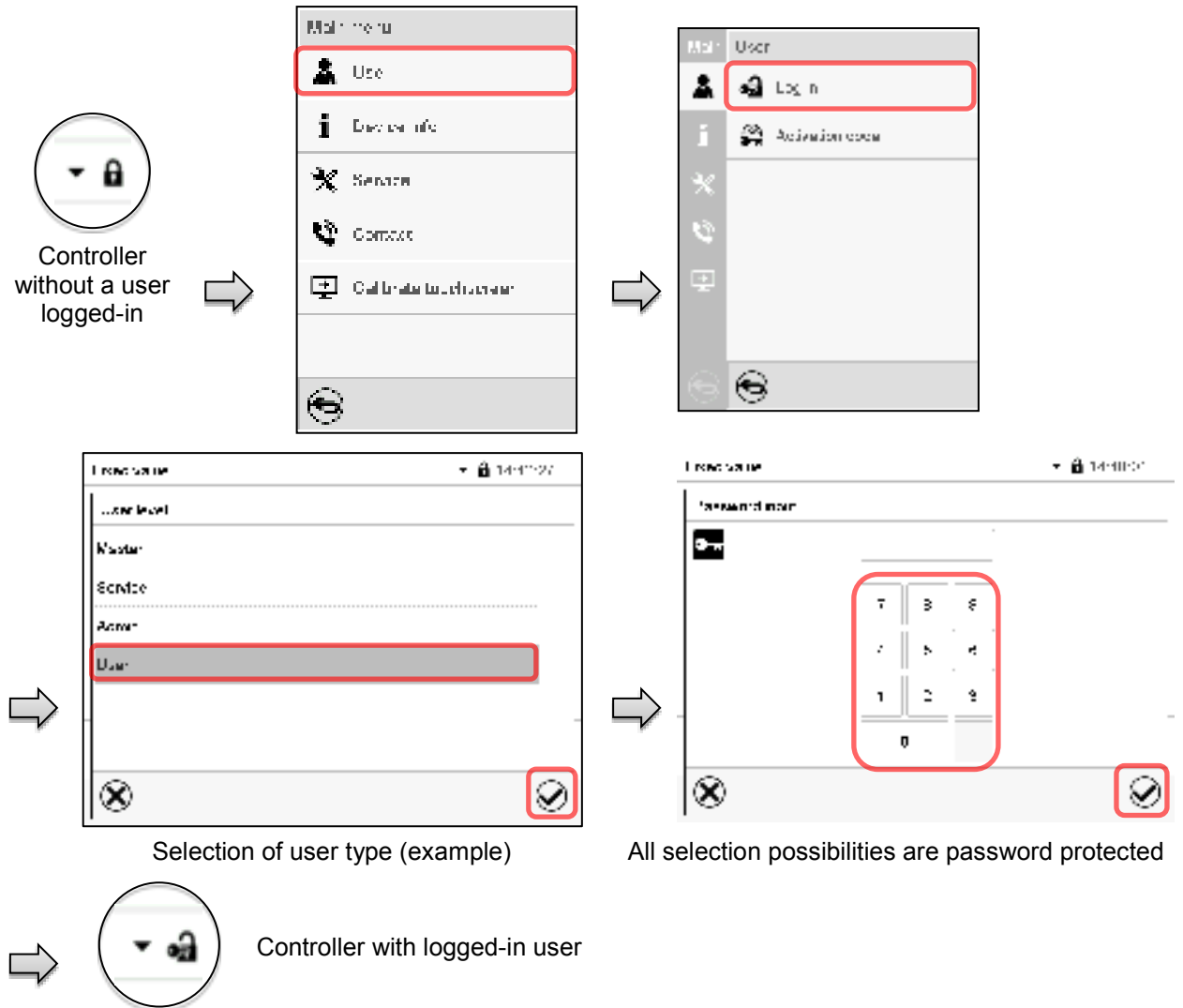

After completing the settings, press the **Confirm** icon to take over the entries and exit the menu, **or** press the **Close** icon to exit the menu without taking over the entries.

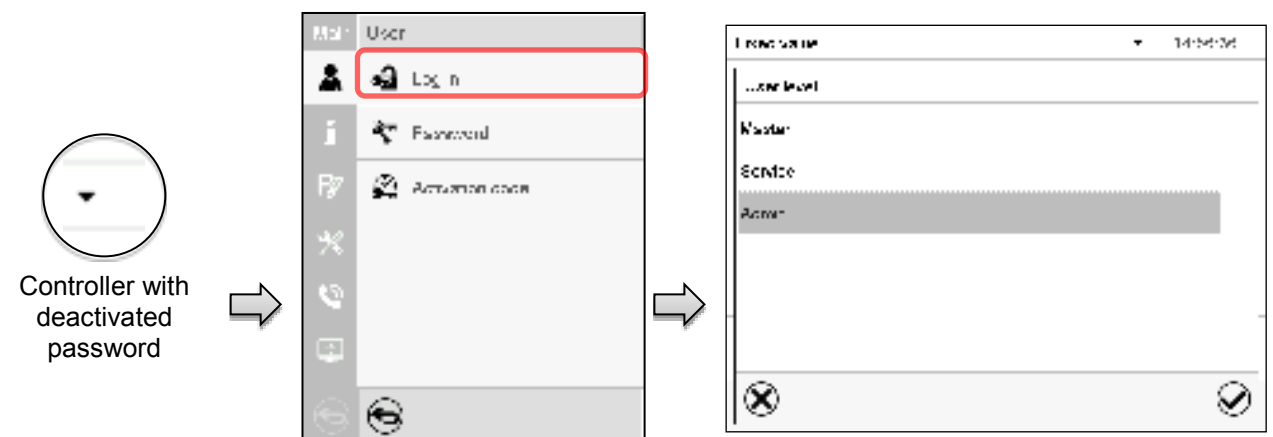

14.3 Log out

Path: [Main menu](#) > [User](#) > [Log out](#)

User logoff with "Admin" authorization

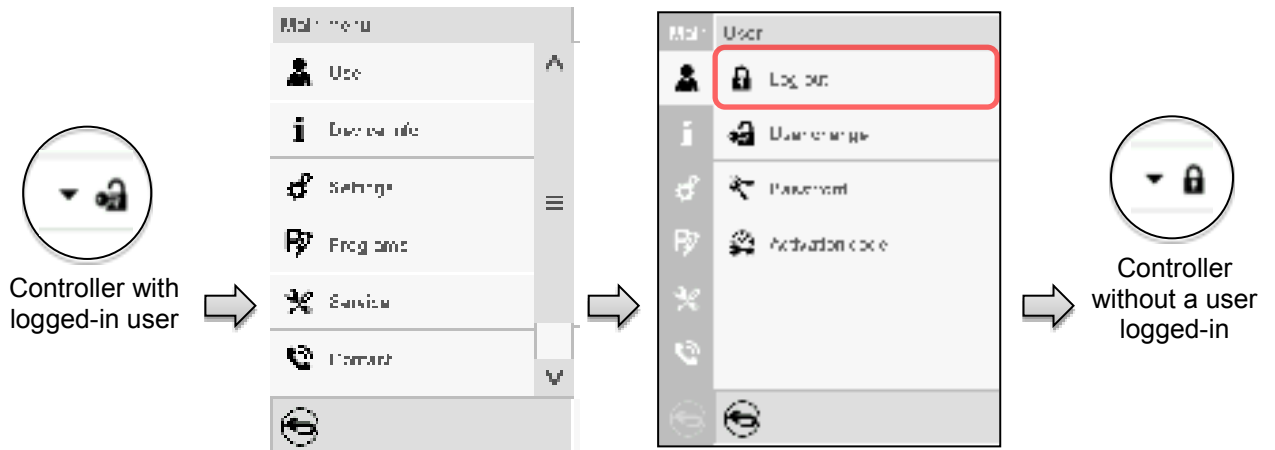

User logoff with "User" authorization



14.4 User change

If the password function has been deactivated (chap.14.5.2) this function is not available.

Path: [Main menu](#) > [User](#) > [User change](#)

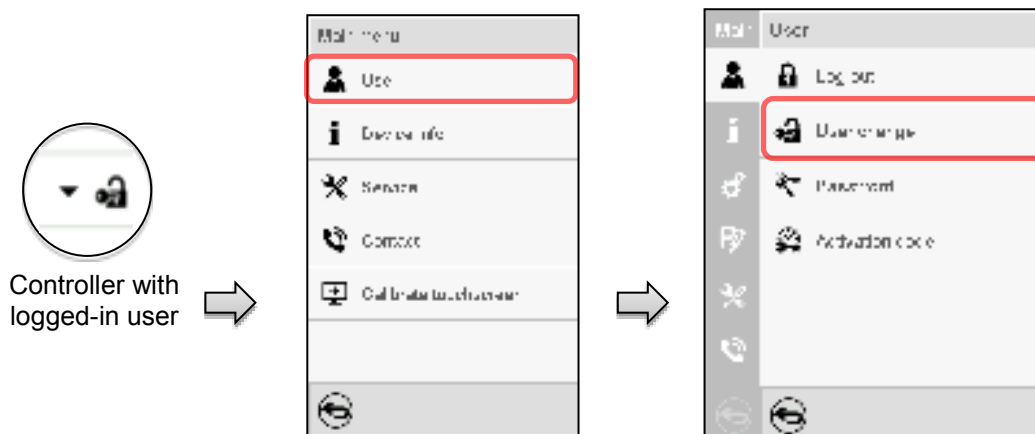

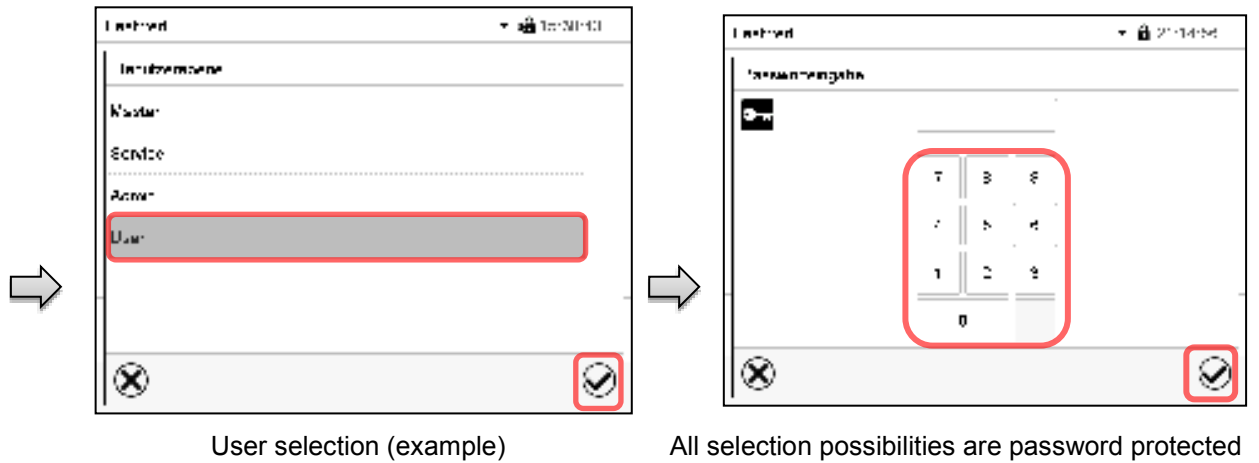

14.5 Password assignment and password change

This function is not available for a user logged-in with “User” authorization.

14.5.1 Password change

A logged-in user can change the passwords of his current level and of the next lower level(s).

Example: A user with “Admin” authorization can change the passwords for the “Admin” and “User” authorization levels.

Path: [Main menu](#) > [User](#) > [Password](#)

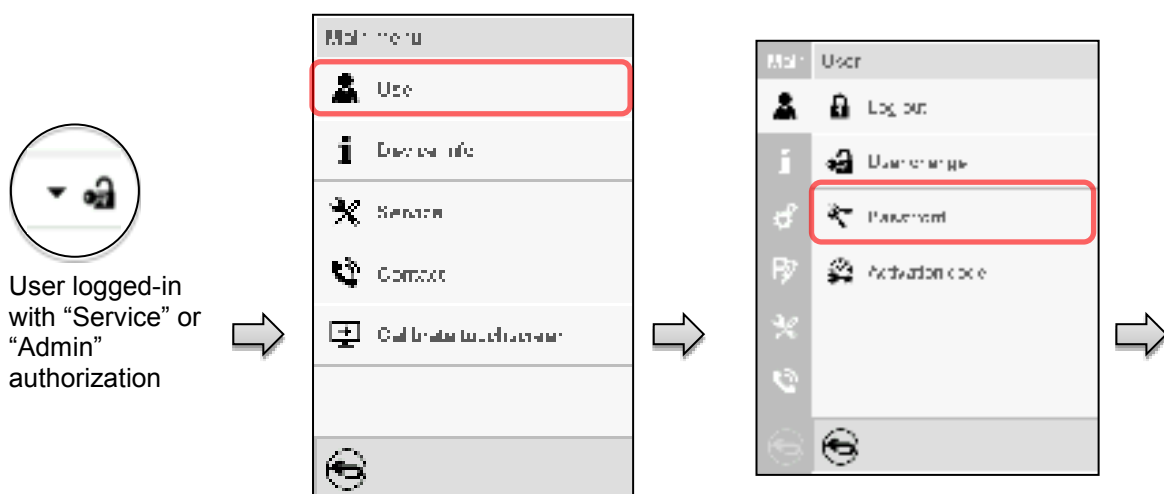

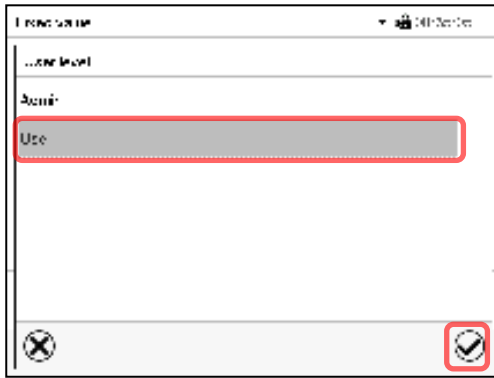

Selection of the authorization level (example: view with “Admin” authorization)

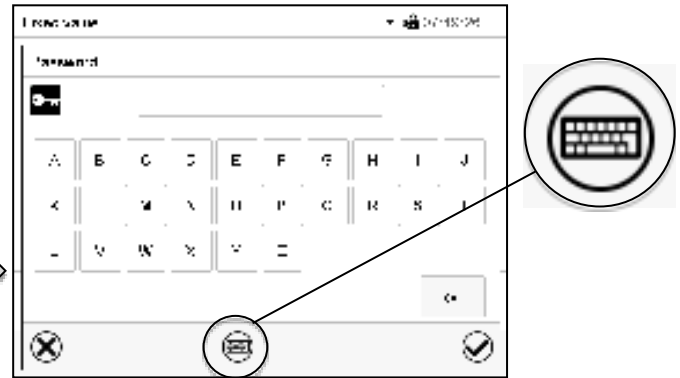

Enter desired password. If desired, press the **Change keyboard** icon to access other entry windows.

In the “Keyboard switch” window you can select different keyboards to enter uppercase and lowercase letters, digits, and special characters. All types of characters can be combined within one single password.

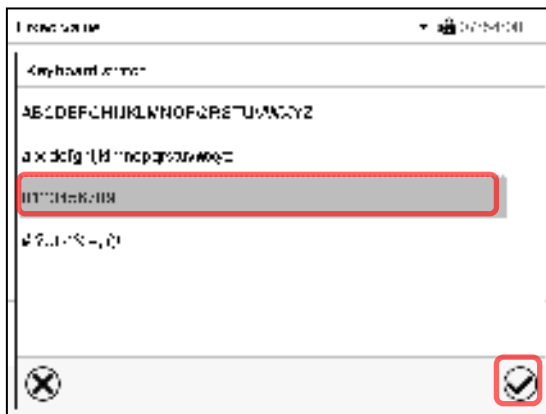

Example: access the digit entry window

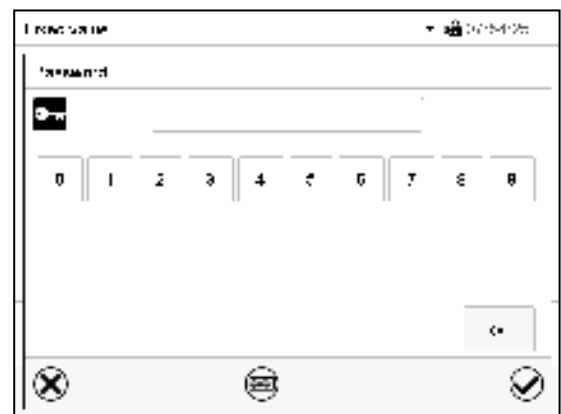

Entry of digits

To confirm the entry, press the **Confirm** icon.



Repeat the password entry for confirmation (sample picture). For each character of the password, the required keyboard appears automatically. Then press the **Confirm** icon.

14.5.2 Deleting the password for an individual authorization level

A user logged-in with “Service” or “Admin” authorization can delete the passwords of his current level and of the next lower level(s). To do this no password is entered during a password change.

Path: *Main menu > User > Password*

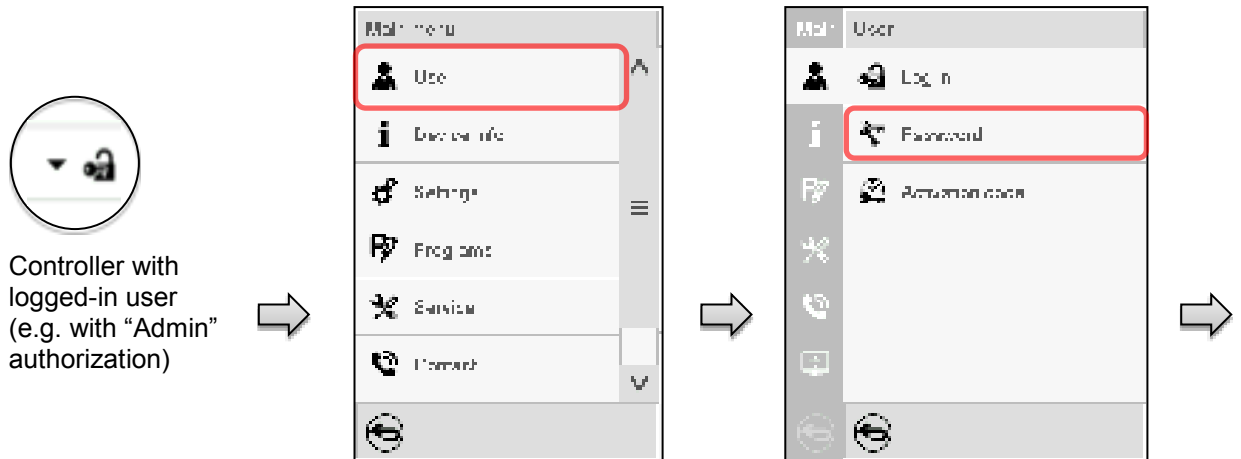

Select the authorization level for which the password shall be deleted.

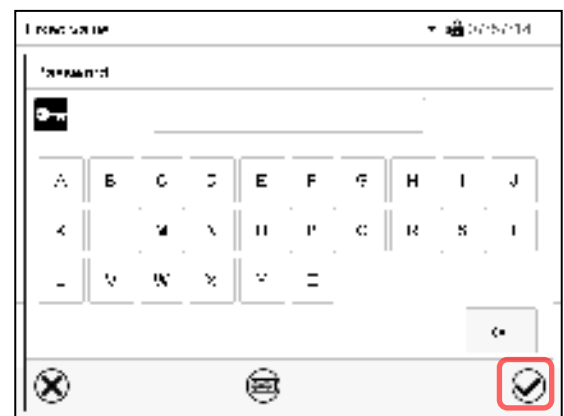

Do NOT enter anything in the “Password” screen. Press the **Confirm** icon.

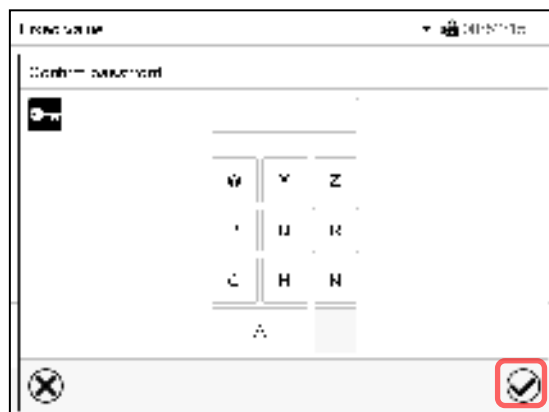

Do NOT enter anything in the “Confirm password” screen. Press the **Confirm** icon.



The password is deleted.

14.5.3 New password assignment for “service” or “admin” authorization level when the password function was deactivated

If the password protection for an authorization level has been deactivated, i.e., no password is assigned, no login for this level is possible. Therefore access to this authorization level is available without login.

If the password for the “Service” or “Admin” authorization has been deleted (chap. 14.5.2), a new password can be assigned for the current level and the next lower level(s) without user login.

Example: The password for the “Admin” authorization level was deleted, therefore every user without login has full access to the functions of the “Admin” authorization level. If access to this level shall become password protected again, the user can assign a new password for the “Admin” authorization level with the “Password” function.

Path: [Main menu](#) > [User](#) > [Password](#)

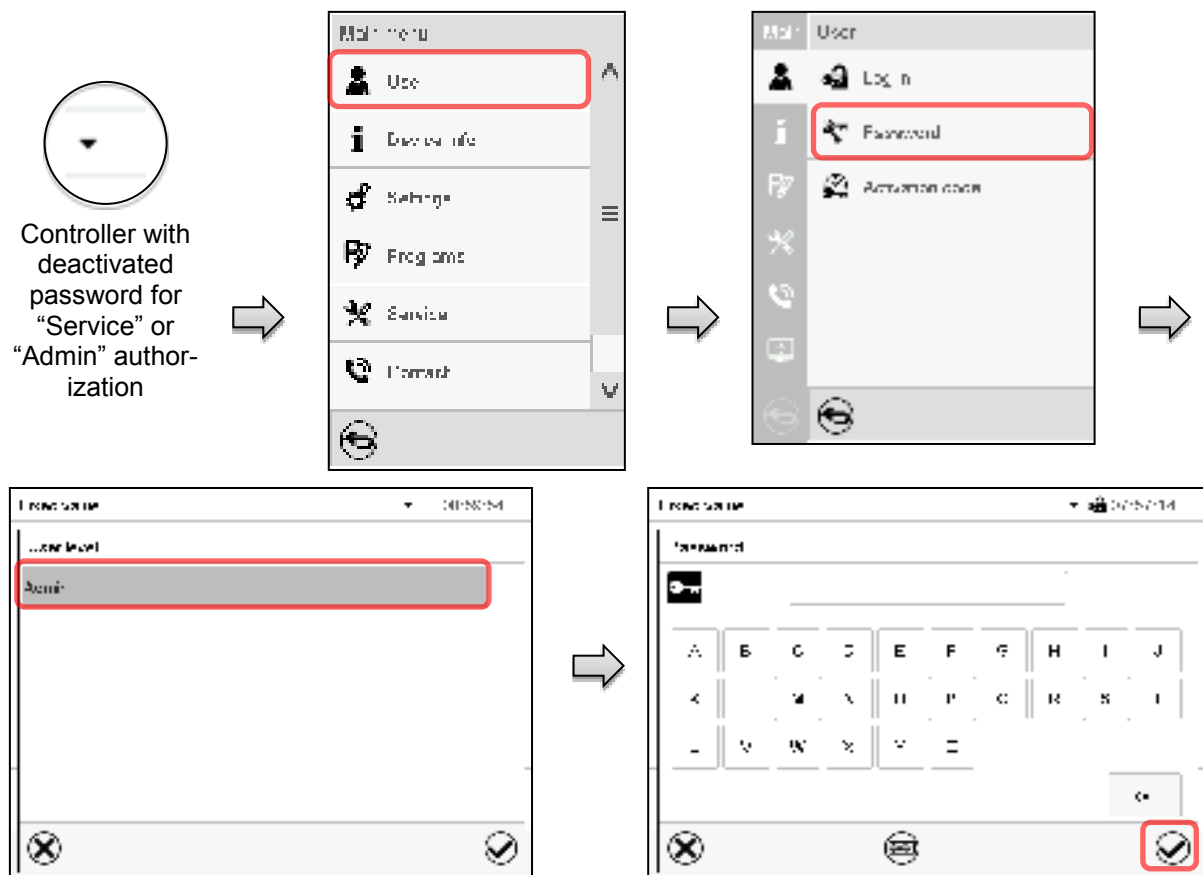

Select the authorization level, for which you want to assign a password.

(Example: “Admin” authorization)

Enter the desired password. If desired, press the **Change keyboard** icon to access other entry windows.

To confirm the entry, press the **Confirm** icon.

Repeat the password entry for confirmation. For each character of the password, the required keyboard appears automatically. Then press the **Confirm** icon.

14.6 Activation code

Certain functions of the controller can be unlocked with a previously generated activation code.

The activation code enables access to functions available only in the “Service” authorization level by users without a “Service” authorization. Such functions include e.g., adjustment or extended configurations.

The activation code is available in authorization levels.

Path: **Main menu > User > Activation code**

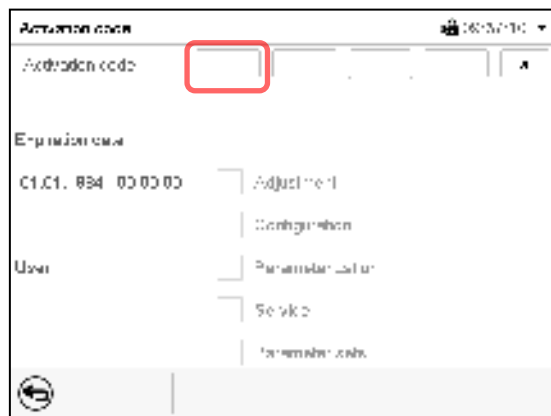
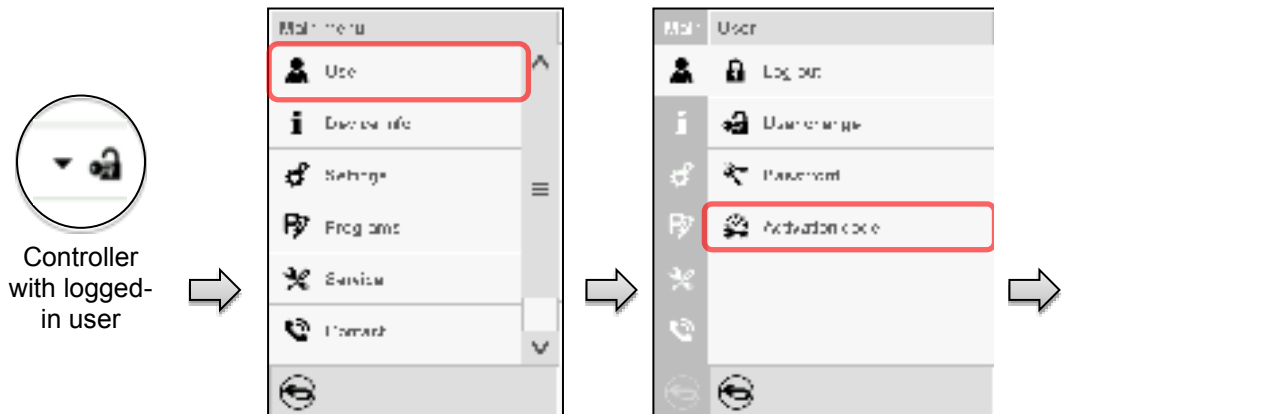

Activation code menu.

Select the first of the four entry fields.

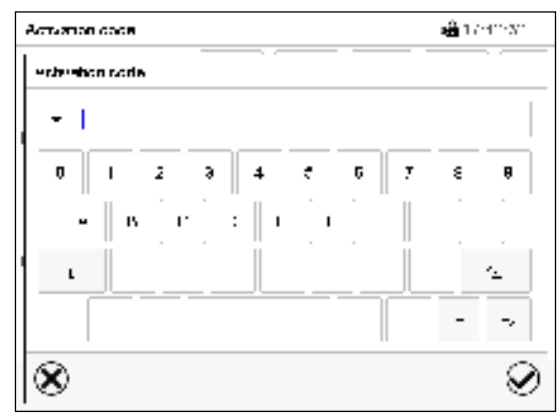

Activation code entry window.

Enter the first four characters of the activation code and press the **Confirm** icon.

Select the next of the four entry fields and proceed accordingly until the entire code has been entered.



“Activation code” menu with entered code (sample view).

Press **OK** to take over the entry

The available functions are indicated by marked checkboxes.
Example: Extended configurations available.

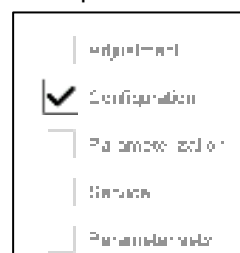

Under “Expiration date” the date of expiry of the code is displayed.

15. General controller settings

Most of the general settings can be accessed in the “Settings” submenu, which is available for users with “Service” or “Admin” authorization level. It serves to enter date and time, select the language for the controller menus and the desired temperature unit and to configure the controller’s communication functions.

15.1 Selecting the controller’s menu language

The MB2 program controller communicates by a menu guide using real words in German, English, French, Spanish, and Italian.

Path: [Main menu](#) > [Settings](#) > [Chamber](#)

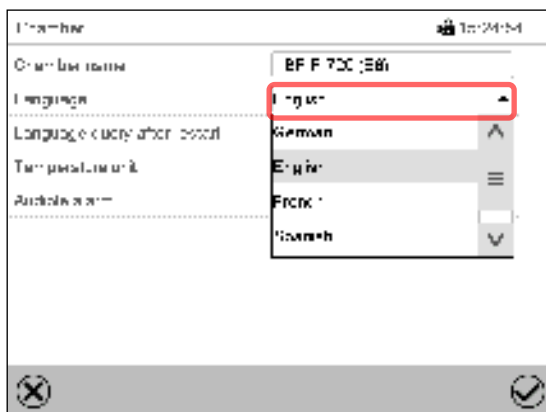

“Chamber” submenu (example).

Select the desired language.

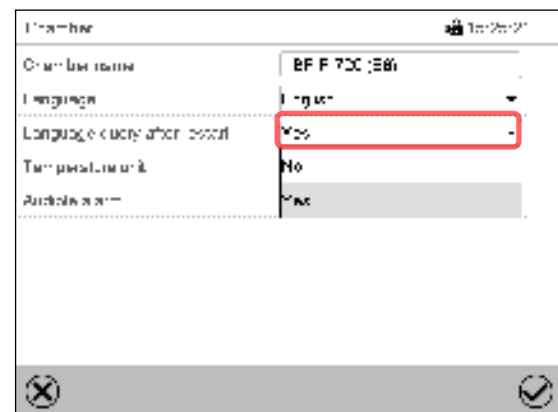

“Chamber” submenu (example).

Select if there shall be a language query after restarting the chamber and press the **Confirm** icon.

Return to Normal display with the **Back** icon to take over the entries.

15.2 Setting date and time

Following start-up of the chamber after language selection:

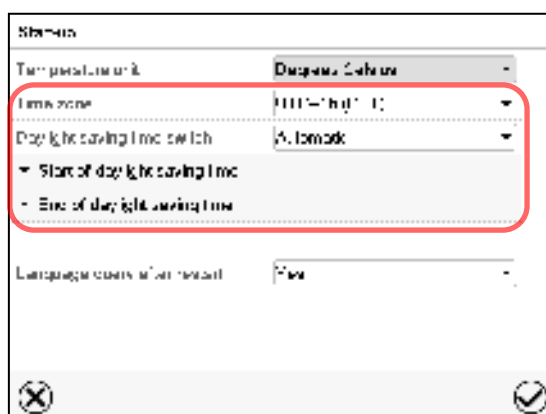

Select the time zone and configure the daylight saving time switch.

Or later:

Path: *Main menu > Settings > Date and time*

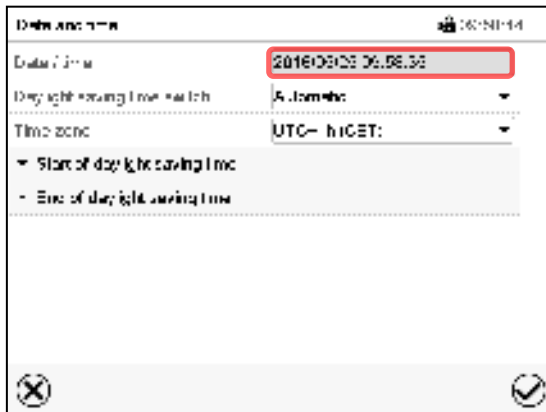

“Date and time” submenu.
Select the field “Date / time”.

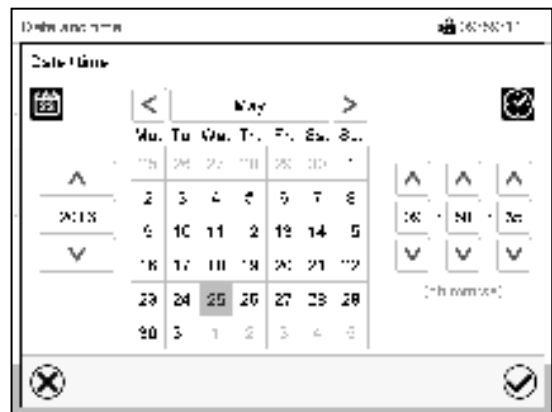

“Date / time” entry menu.
Enter date and time and press the **Confirm** icon.

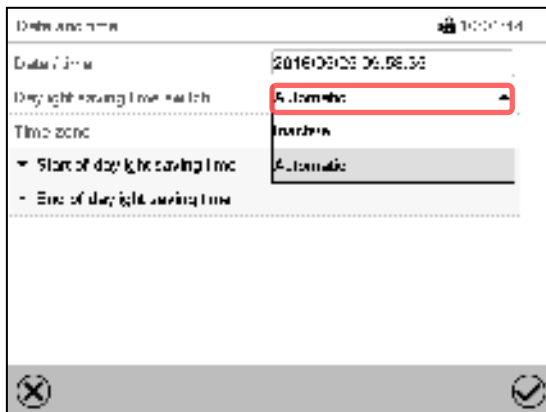

“Date and time” submenu.
In the field “Daylight saving time switch” select the desired setting “Automatic” or “Inactive”.

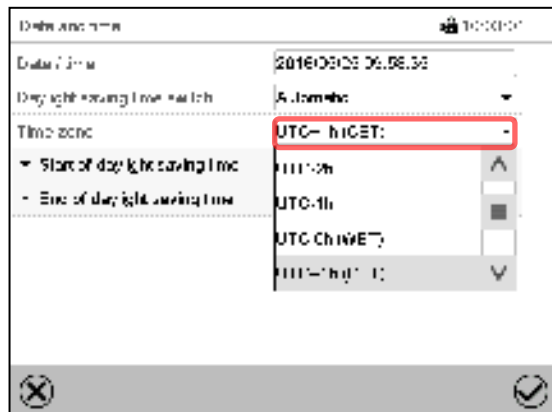

“Date and time” submenu.
Select the desired time zone and press the **Confirm** icon.



“Date and time” submenu.
Select the desired start of the daylight saving time.

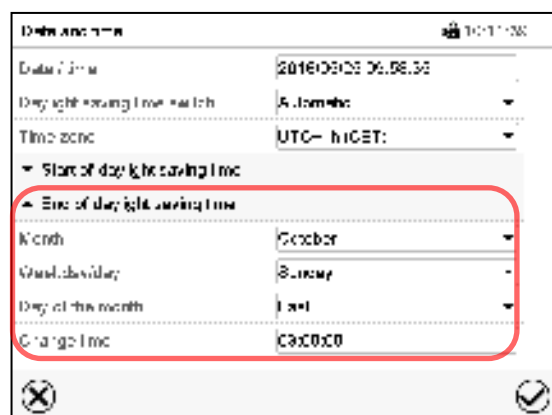

“Date and time” submenu.
Select the desired end of the daylight saving time and press the **Confirm** icon.

After completing the settings, press the **Confirm** icon to take over the entries and exit the menu, **or** press the **Close** icon to exit the menu without taking over the entries.

15.3 Selecting the temperature unit

Following start-up of the chamber:

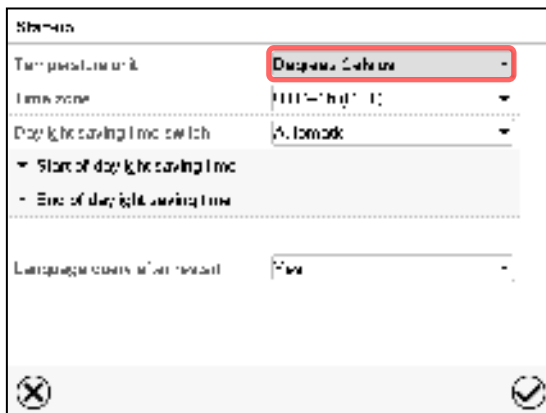

Or later:

Path: [Main menu](#) > [Settings](#) > [Chamber](#)

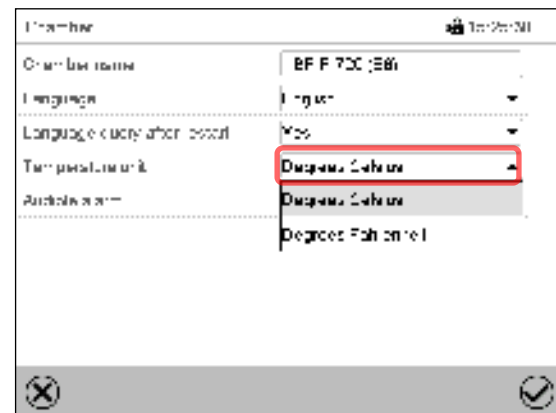

Select the desired temperature unit and press the **Confirm** icon.

Change of the temperature unit between °C and °F.

If the unit is changed, all values are converted accordingly

	C = degree Celsius	0 °C = 32°F	Conversion: [value in °F] = [value in °C] * 1,8 + 32
	F = degree Fahrenheit	100 °C = 212°F	

15.4 Display configuration

15.4.1 Adapting the display parameters

This function serves to configure parameters like display brightness and operating times.

Path: [Main menu](#) > [Settings](#) > [Display](#) > [Display](#)

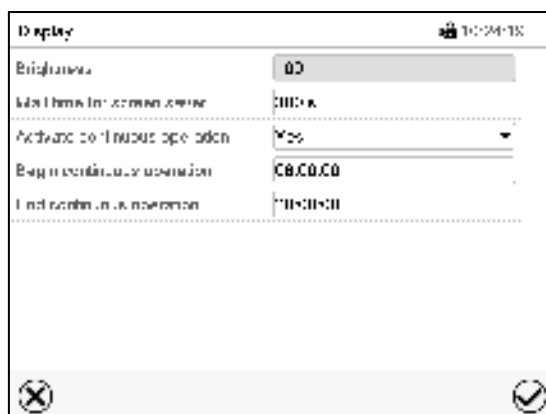

“Display” submenu.

- Select the field “Brightness”.
- Move the grey slide to the left or right to define the brightness of the display
- left = darker (minimum value: 0)
 - right = brighter (maximum value: 100)
- Press the **Confirm** icon.



- Select the field “Wait time for screen saver” and enter the desired waiting time for the screen saver in seconds. Setting range: 10 sec up to 32767 sec. During the waiting time the display is off. Confirm entry with **Confirm** icon.
- In the field “Activate continuous operation” select the desired setting “Yes” or “No”.



- Select the field “Begin continuous operation” (possible only if continuous operation is activated) and enter the time with the arrow keys. Confirm entry with **Confirm** icon.
- Select the field “End continuous operation. (only possible if continuous operation is activated) and enter the time with the arrow keys. Confirm entry with **Confirm** icon.

After completing the settings, press the **Confirm** icon to take over the entries and exit the menu, **or** press the **Close** icon to exit the menu without taking over the entries.

15.4.2 Touchscreen calibration

This function serves to optimize the display for the user’s individual angular perspective.

Path: [Main menu](#) > [Calibrate touchscreen](#)

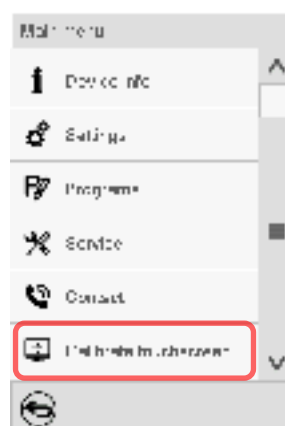

Normal display.

Select “Calibrate touchscreen” and follow the instructions on the display.

You need to touch all four corners of the touchscreen to calibrate it. Appropriate boxes appear successively in each corner.



The waiting icon shows how much time there is left to touch the currently activated box. If the box is not touched within this period, calibration is aborted and the display changes to Normal display.

After completing the calibration, i.e., touching all four boxes, the display changes to Normal display.

15.5 Network and communication

For these settings at least the “Admin” authorization level is required.

15.5.1 Serial interfaces

The chamber is optionally equipped with a serial RS485 interface.

This menu allows to configure the communication parameters of the RS485 interface.

The device address is required to recognize chambers with this interface type in a network, e.g. when connecting it to the optional APT-COM™ 4 Multi Management Software (chap. 21.1). In this case do not change the other parameters.

Path: [Main menu](#) > [Settings](#) > [Serial interfaces](#)

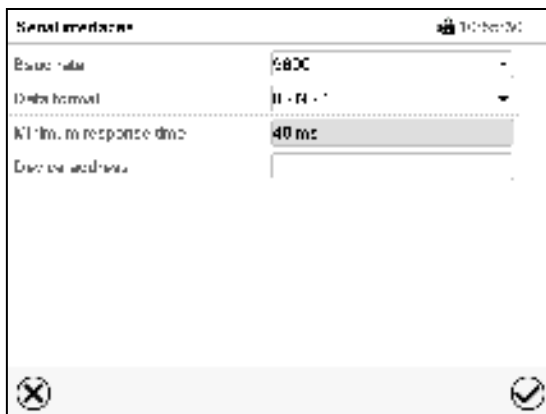

“Serial interfaces” submenu.

- Select the desired setting in the field “Baud rate”.

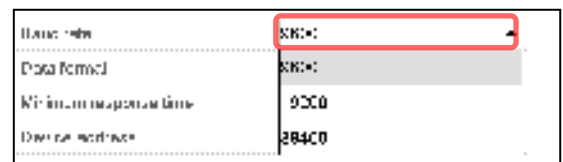

- Select the desired setting in the field “Data format”.

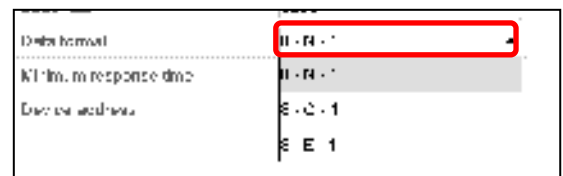

- Select the field “Minimum response time” and enter the desired minimum response time. Confirm entry with **Confirm** icon.
- Select the field “Device address” and enter the device address. Factory setting is “1”. Confirm entry with **Confirm** icon.

After completing the settings, press the **Confirm** icon to take over the entries and exit the menu, **or** press the **Close** icon to exit the menu without taking over the entries.

15.5.2 Ethernet

15.5.2.1 Configuration

Path: [Main menu](#) > [Settings](#) > [Ethernet](#)



“Ethernet” submenu.

- In the field “IP address assignment” select the desired setting “Automatic (DHCP)” or “Manual”.

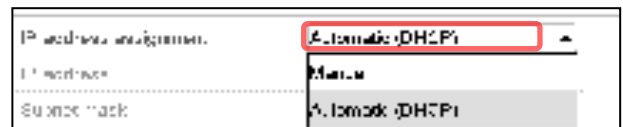

With selection “Manual” you can enter the IP-address, the subnet mask and the standard gateway manually.

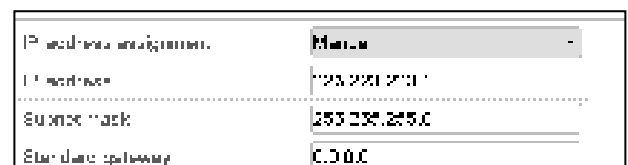

- Select “DNS device name” and enter the DNS device name. Confirm entry with **Confirm** icon.
- In the field “DNS server address” select the desired setting “Automatic” or “Manual”.

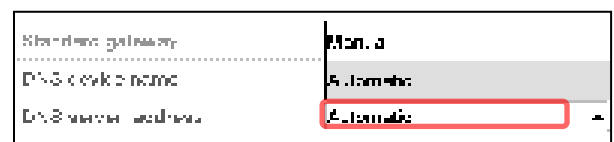

With selection „Manual“ you can enter the DNS server address manually.

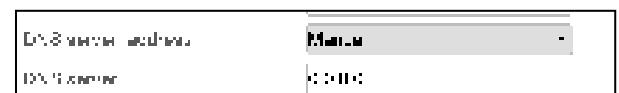

After completing the settings, press the **Confirm** icon to take over the entries and exit the menu, **or** press the **Close** icon to exit the menu without taking over the entries.

15.5.2.2 Display of the MAC address

Path: [Main menu > Device info > Ethernet](#)



“Ethernet” submenu (example values).

15.5.3 Web server

This controller menu serves to configure the web server. Then you can enter the chamber’s IP-address in the Internet. The IP address is available via [Chamber information > Ethernet](#). The BINDER web server opens. Enter the user name and password which have been assigned for the web server in the controller menu. This enables online access to the controller display, to see e.g., the event list or error messages. In this view no settings can be changed.

Path: [Main menu > Settings > Web server](#)

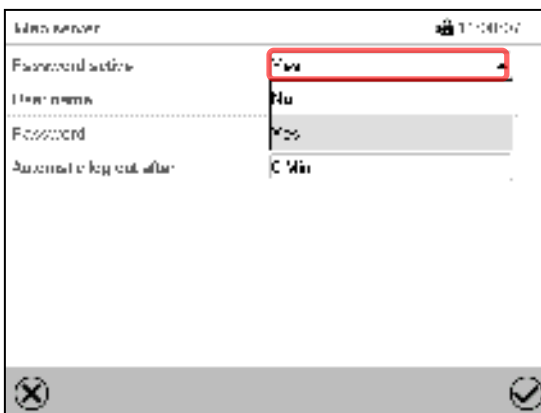

“Webserver” submenu.

- In the field “Password active” select the desired setting “Yes” or “No”.

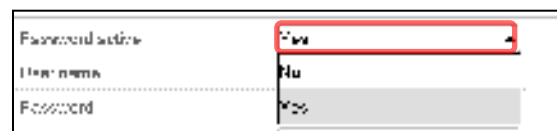

- Select the field “User name” and enter the desired user name. Confirm entry with **Confirm** icon.
- Select the field “Password” and enter the desired password. Confirm entry with the **Confirm** icon.
- Select the field “Automatic log out after” and enter the time in minutes after which the webserver shall log out automatically. Setting range: 0 min to 65535 min. Confirm entry with **Confirm** icon.

After completing the settings, press the **Confirm** icon to take over the entries and exit the menu, **or** press the **Close** icon to exit the menu without taking over the entries.

15.5.4 E-Mail

As soon as an alarm was triggered, an e-mail is sent to the configured e-mail address.

Path: [Main menu](#) > [Settings](#) > [Email](#)

E-mail address entry:

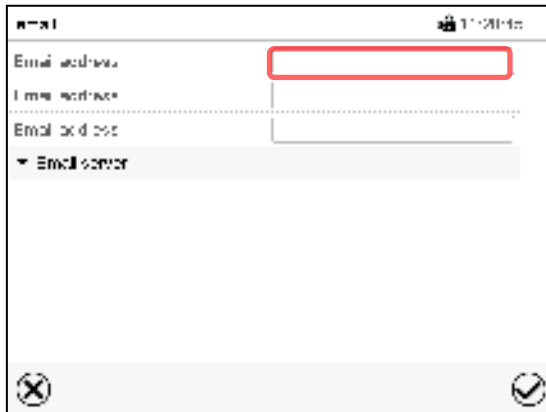

“Email” submenu.

Select the desired e-mail address field and enter the e-mail address. You can use the **Keyboard change** icon for entry. Confirm entry with **Confirm** icon.

E-mail server settings:



“Email” submenu.

Select the field “Email server” to access the settings

- In the field “Authentication” select the desired setting “None” or “SMTP” auth“.

With the setting “SMTP auth”, you can enter a password under “Email password”.

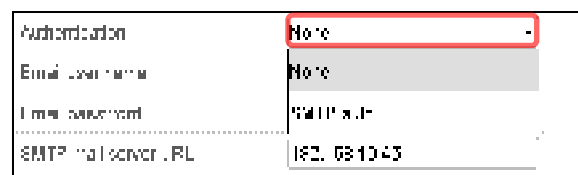

- Select the field “Email user name” and enter the desired user name. Confirm entry with **Confirm** icon.
- Select the field “SMTP mail server URL” and enter the SMPT mail server URL. Confirm entry with **Confirm** icon.
- Select the field “SMTP port number” and enter the desired port number. Standard setting: “25”. Confirm entry with **Confirm** icon.
- Select the field “Email sender” and enter the desired Email sender. Confirm entry with **Confirm** icon.

After completing the settings, press the **Confirm** icon to take over the entries and exit the menu, **or** press the **Close** icon to exit the menu without taking over the entries.

15.6 USB menu: Data transfer via USB interface

The USB port is located in the instrument box.

When you insert a USB-stick, the “USB” menu opens.

Depending on the user’s authorization level, different functions (highlighted in black) are available for the logged-in user.



Available functions
with “User” authorization level

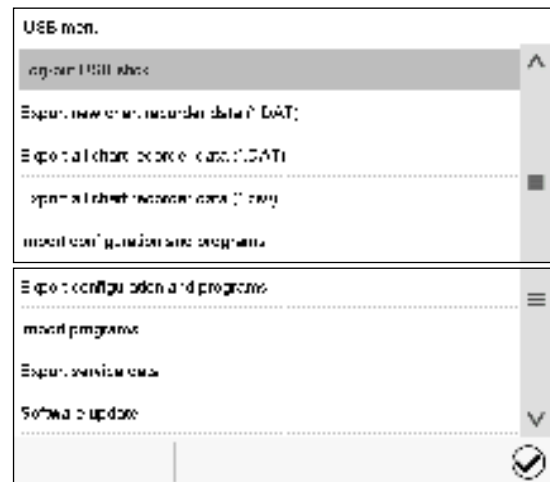

Available functions
with “Admin” authorization level

Function	Explanation
Log-out USB stick	Log-out USB stick bevor pulling it
Export new chart recorder data (*.DAT)	Export chart recorder data, which have been added since last export, in .dat format
Export all chart recorder data (*.DAT)	Export all chart recorder data in .dat format
Export all chart recorder data (*.csv)	Export all chart recorder data in .csv format
Import configuration and programs	Import configuration and timer / time / week programs
Export configuration and programs	Export configuration and timer / time / week programs
Import programs	Import timer / time / week programs
Export service data	Export service data (including self-test data, chap. 16.5)
Software update	Controller firmware update

16. General information

16.1 Service contact page

Path: *Main menu > Contact*



16.2 Current operating parameters



Press the *Information* icon to access the “Info” menu from Normal display.



“Info” menu.
Select the desired information.

- Select “Program operation” to see information on a currently running program.
- Select “Setpoints” to see information on the entered setpoints and on the light commutation and special controller functions.
- Select “Actual values” to see information on the current actual values.
- Select “Safety controller” to see information on the safety controller status.

16.3 Event list

The “Event list” displays status information and errors of the current day. It enables to view the last 100 events or defective conditions of the chamber.

 Press the **Event list** icon to access the event list from Normal display.



Event list

 Press the **Update** icon to update the event list.

 **Attention:** Following a modification of the language setting (chap. 15.1) or the storage interval of the chart recorder (chap. 17.2) the Event list is cleared.

16.4 Technical chamber information

Path: [Main menu](#) > [Device info](#)

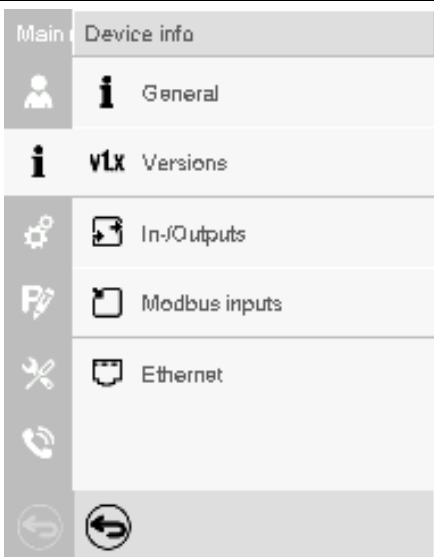
									
	Chamber name and setup								
	<table border="1" style="width: 100%; border-collapse: collapse;"> <tr> <td style="width: 70%;">Versions of CPU, I/O module and safety controller</td> <td>for BINDER Service</td> </tr> <tr> <td>Information on digital and analog inputs and outputs and phase angle outputs</td> <td>for BINDER Service</td> </tr> <tr> <td>Information on modbus analog and digital inputs</td> <td>for BINDER Service</td> </tr> <tr> <td>Information on Ethernet connection, MAC address display</td> <td>chap. 15.5.2</td> </tr> </table>	Versions of CPU, I/O module and safety controller	for BINDER Service	Information on digital and analog inputs and outputs and phase angle outputs	for BINDER Service	Information on modbus analog and digital inputs	for BINDER Service	Information on Ethernet connection, MAC address display	chap. 15.5.2
Versions of CPU, I/O module and safety controller	for BINDER Service								
Information on digital and analog inputs and outputs and phase angle outputs	for BINDER Service								
Information on modbus analog and digital inputs	for BINDER Service								
Information on Ethernet connection, MAC address display	chap. 15.5.2								
	Back to main menu								

16.5 Self-test function

The self-test function enables an automated check of the proper chamber functioning as well as a targeted and reliable fault analysis. It is available with the “Master”, “Service”, and “Admin” authorization levels.

In this case, the chamber successively undergoes various defined operating states, which serves to determine reproducible characteristic values. These characteristic values provide information on the performance and precision of the individual functional systems of the chamber (e.g., heating, refrigeration, humidification) of the chamber.

The results of the self-test are stored in the service recorder of the controller. You can export them using the controller’s USB interface and send them to BINDER Service (use function “Export service data” to USB stick, chap. 15.6). BINDER Service will evaluate the data using an analyzing tool.

Activating the self-test mode



In order to allow an optimum comparison of the determined characteristic values with the reference characteristic values, the ambient temperature should be in the range of $+22\text{ °C} \pm 3\text{ °C}$ / $71.6\text{ °F} \pm 5.4\text{ °F}$.

The chamber shall be unloaded (empty with standard equipment).

Path: [Main menu](#) > [Settings](#) > [Various](#)

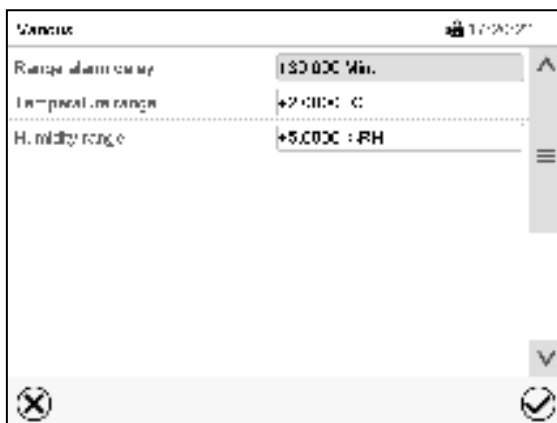

Submenu “Various”.

Scroll all the way down to access the “Self-test” function.

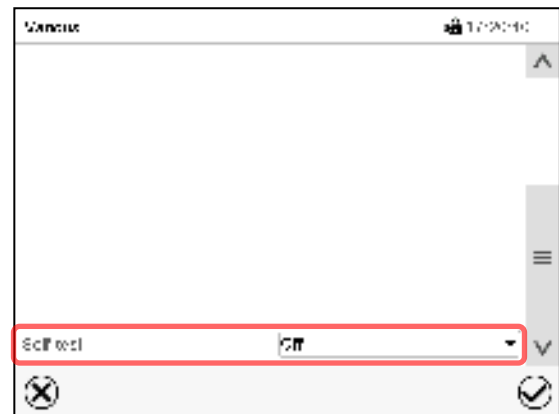

Submenu “Various”.

Select the field “Self-test”.

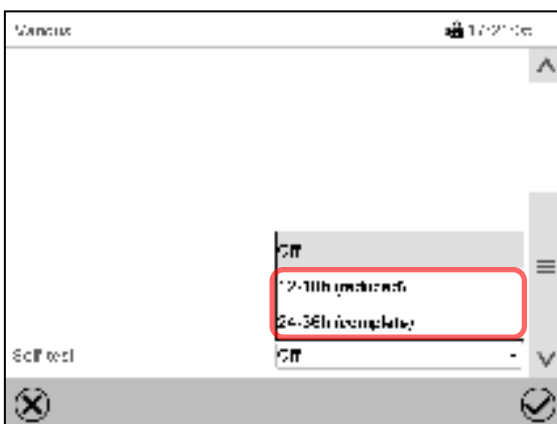

Submenu “Various”.

To start the self-test, select the desired test duration. Confirm entry with **Confirm** icon.

Return to Normal display with the **Back** icon to take over the entries.



Alarm message “Self-test active”.

The self-test program is running. The indicated set-points are non-functional.

With enabled buzzer: the buzzer sounds.
Press the **Alarm** icon to access the “Active alarms” menu.



“Active alarms” menu.

The zero-voltage relay alarm output is not activated with the alarm message “Self-test active”.
Press the **Reset alarm** icon to mute the buzzer.



Do not open and do not turn off the chamber while self-test is running.

After an interruption of the voltage supply, the self-test restarts.

Deactivating the self-test mode

Opening the chamber door will cancel the self-test.

This step allows you to cancel the self-test or deactivate the self-test mode after the chamber has completed the self-test or the self-test has been cancelled.

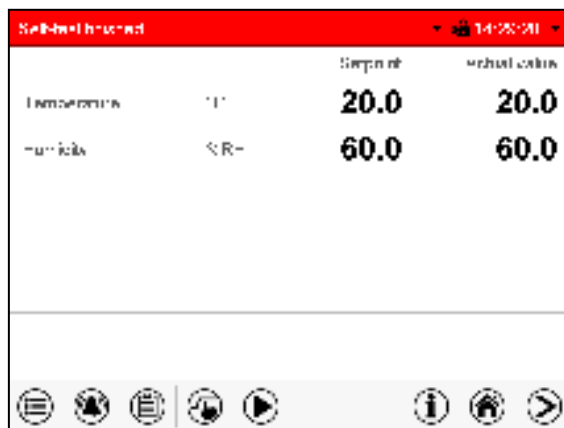

Alarm message “Self-test finished”.

The chamber is in Fixed-value mode and equilibrates to the indicated set-points.

With enabled buzzer: the buzzer sounds. Press the **Alarm** icon to access the “Active alarms” menu.
Press the **Reset alarm** icon to mute the buzzer.

The self-test is completed. You can now deactivate the self-test mode.

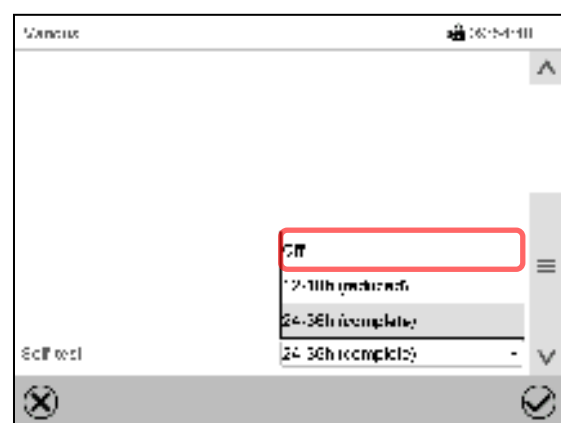

Submenu “Various”.

Select the setting “off” to deactivate the self-test mode after the self-test is completed or has been cancelled by opening the door, or to cancel a running self-test.

Confirm entry with **Confirm** icon.



The alarm messages “Self-test active” and “Self-test finished” do not activate the zero-voltage relay alarm output. They are listed in the Event list.

17. Chart recorder display

This view offers graphic representation of the measurement course. Data representation imitates a chart recorder and allows recalling any set of measured data at any point of time taken from the recorded period.

17.1 Views

	Press the Change view icon to access the pen recorder display.
--	---

17.1.1 Show and hide legend

	Show legend		Hide legend
--	--------------------	--	--------------------

Press the **Show legend** icon to display the legend on the right side of the display.

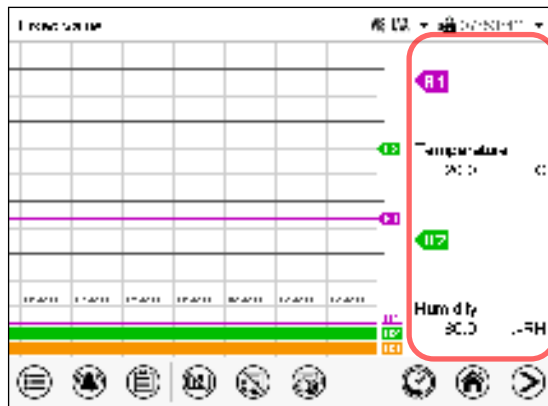

Legend shown on the right side of the display

Display with KBF P / KBF P-UL, KBWF

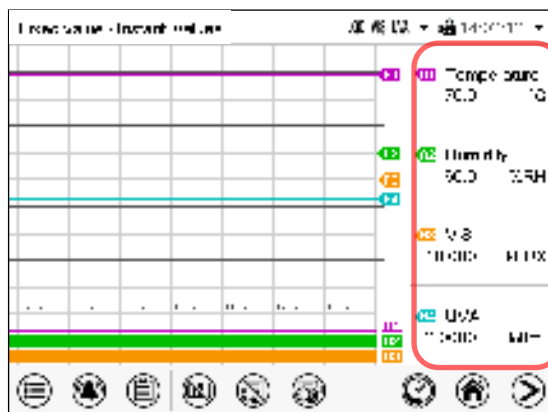

Display with KBF LQC / KBF LQC-UL – first page

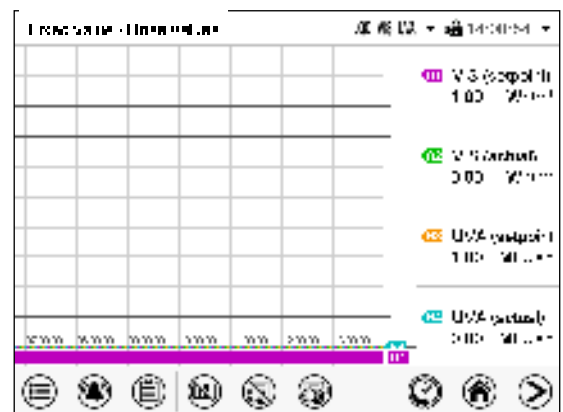

Display with KBF LQC / KBF LQC-UL – second page

17.1.2 Switch between legend pages



Switch legend

Press the **Switch legend** icon to switch between the legend pages

<p>1st page</p>	↔	<p>2nd page</p>	<p>1st page</p>	↔	<p>2nd page</p>	<p>1st page</p>	↔	<p>2nd page</p>
<p>Display with KBF P / KBF P-UL</p>		<p>Display with KBWF</p>		<p>Display with KBF LQC / KBF LQC-UL</p>				

17.1.3 Show and hide specific indications



Show indications

Hide indications

Press the **Show indications** icon to display specific indications

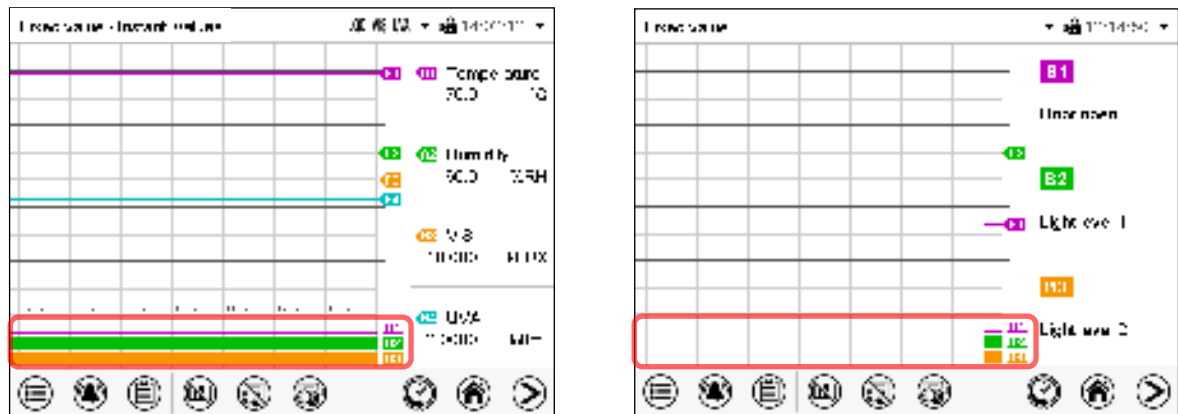

Indications shown with KBF P / KBF P-UL, KBF LQC / KBF LQC-UL:

- “Door open” (B1)
- “Light UVA” (B2)
- “Light VIS” (B3)

Indications shown with KBWF:

- “Door open” (B1)
- “Light Level 1” (B2)
- “Light Level 2” (B3)

17.1.4 History display



Press the **History display** icon to change to the history display.

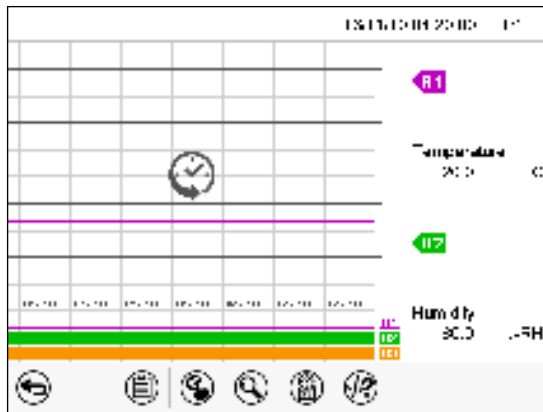

History display with KBF P / KBF P-UL, KBWF

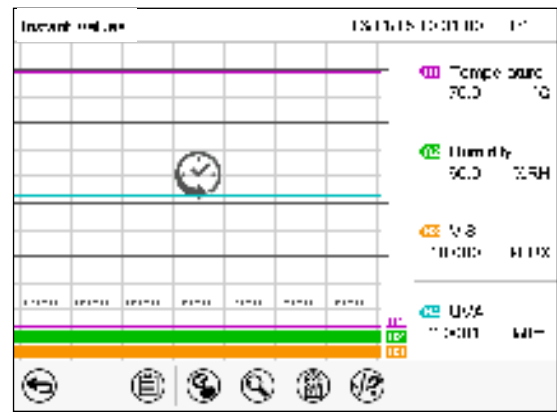

History display with KBF LQC / KBF LQC-UL.

The chart recorder is paused. Data recording continues in the background.

Move the central red line by tapping and holding to the desired position.

The legend at the right side shows the values of the current line position.

Then further icons appear:

History display: Curve selection

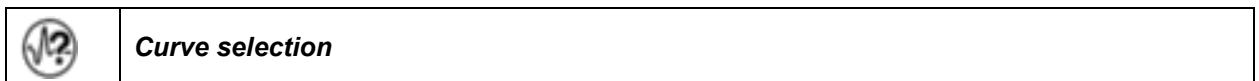

Press the **Curve selection** icon to access the “Curve selection” submenu.

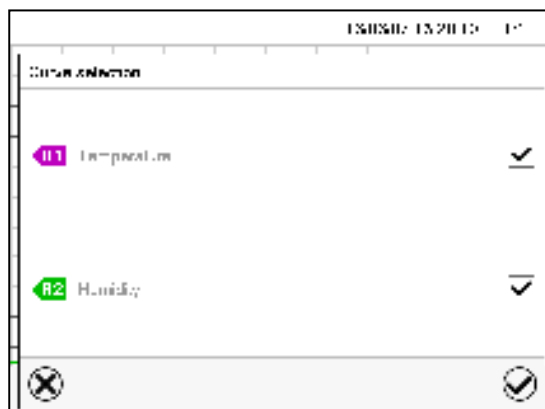

“Curve selection” submenu with KBF P / KBF P-UL, KBWF



“Curve selection” submenu with KBF LQC / KBF LQC-UL.

Select the curves to be displayed by checking the checkbox of the corresponding parameter. Press the **Confirm** icon.

History display: Search the required instant

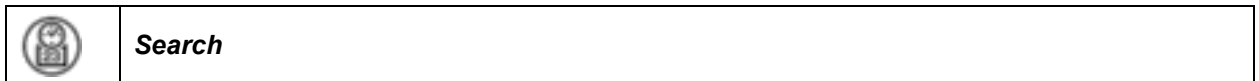

Press the **Search** icon to access the "Search" submenu.

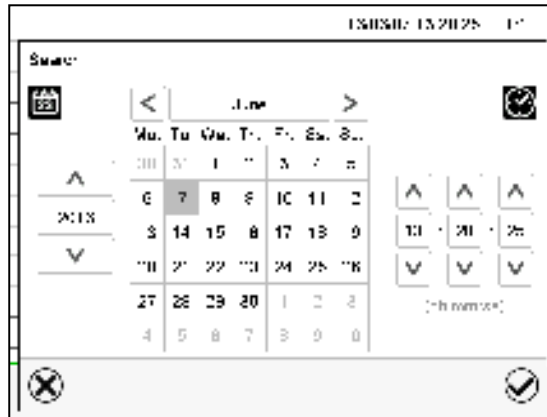

"Search" submenu.

Select the required instant by entering its date and time and press the **Confirm** icon.

History display: Zoom function

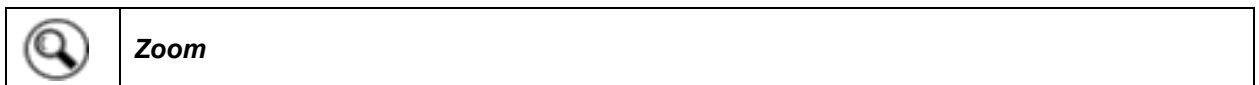

Press the **Zoom** icon to access the "Zoom" submenu.

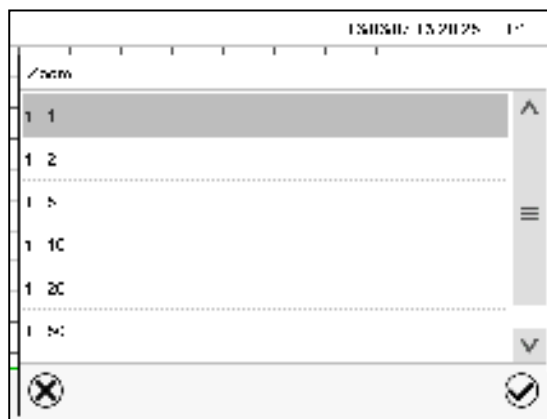

"Zoom" submenu.

Select the zoom factor and press the **Confirm** icon.

History display: Show and hide scroll buttons to scroll to an instant



Press the **Show scroll buttons** icon to access the “Page selection” submenu.

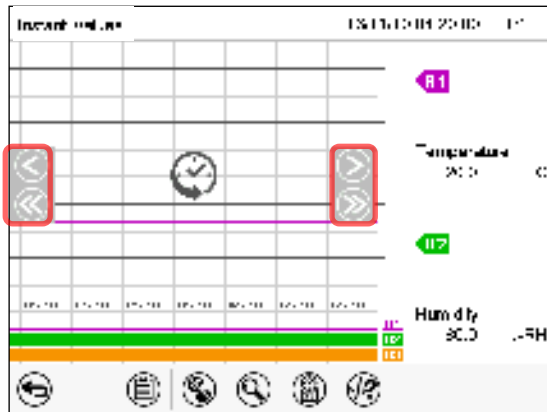

“Page selection” submenu with KBF P / KBF P-UL, KBWF

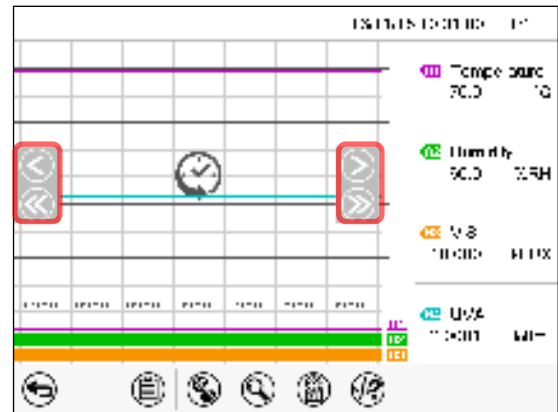

“Page selection” submenu with KBF LQC / KBF LQC-UL

Scroll buttons are shown on the left and on the right. Use them to move along the timeline.

17.2 Setting the parameters

This menu allows setting the storage interval, the type of values to be shown and the scaling of the temperature and humidity charts.

Path: [Main menu](#) > [Settings](#) > [Measurement chart](#)

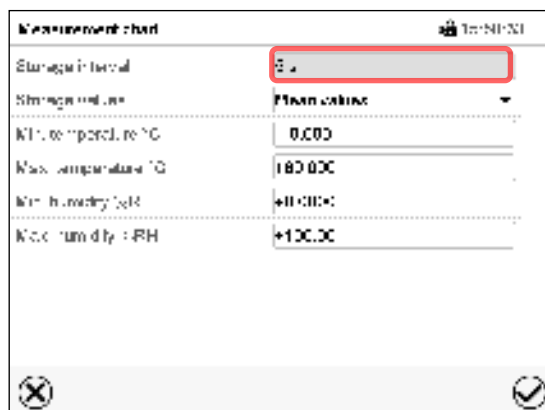

“Measurement chart” submenu with KBF P / KBF P-UL, KBWF

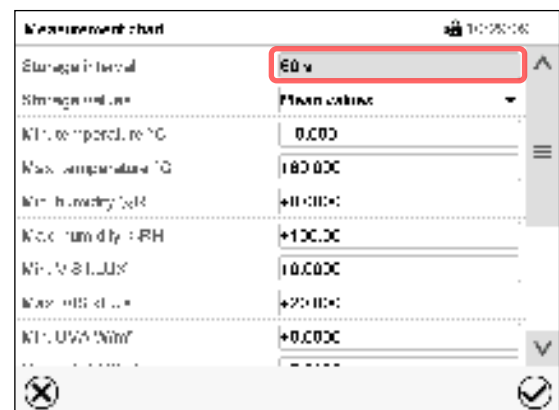

“Measurement chart” submenu with KBF LQC / KBF LQC-UL

- Select the field “Storage interval” and enter the desired storage interval. Confirm entry with **Confirm** icon.

The available presentation depends on the pre-selected storage rate. Factory setting: 60 seconds. This means the higher the storage rate, the more precisely but shorter the data representation will be.

- In the field “Storage values” select the desired value type to be displayed.

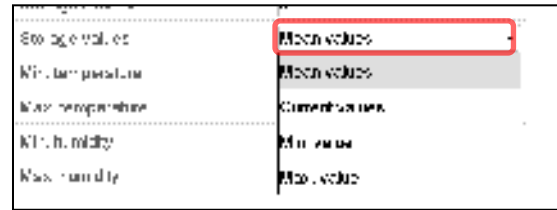

(example: KBF P / KBF P-UL, KBWF)

- For scaling the representation select the minimum and maximum temperature or humidity value and, with KBF LQC, the desired minimum and maximum VIS or UVA dose target value. Enter the desired values. Confirm each entry with **Confirm** icon

Display ranges:

- Temperature: -10 °C up to 80 °C
- Humidity: 0% r.h. up to 100% r.h
- VIS dose: 0-99999 MLuxh
- UVA dose: 0-99999 Wh/m²

Setting the storage rate or rescaling (minimum and/or maximum) will clear the measured-value memory and the event list.

	NOTICE
	<p>Danger of information loss when setting the storage rate or rescaling. Data loss of measured-value memory and event list.</p> <p>➤ Change the storage rate or scaling ONLY if the previously registered data is no longer needed.</p>

After completing the settings, press the **Confirm** icon to take over the entries and exit the menu, **or** press the **Close** icon to exit the menu without taking over the entries.

18. Humidification / dehumidification system

The chamber is equipped with a capacitive humidity sensor. This results in a control accuracy of up to $\pm 3\%$ r.h. of the set point. The temperature-humidity diagrams show the possible working ranges for humidity.

- In the “setpoints” menu you can turn humidity control (humidification and dehumidification) on or off with the setting “Control on/off” (chap. 6.3).

With humidity control turned off, the humidification module cools down. After activation it will take up to 20 minutes until the humidification function is fully available again. This setting is required when operating the chamber without a water connection in order to avoid humidity alarms.

- Operation line “Humidity off” serves to turn off the humidification / dehumidification system in Fixed value operation (chap. 8.4, time program operation (chap. 10.7.3) and week program operation (chap. 11.6.5). This allows configuring the disconnection for individual program sections.

When the humidification / dehumidification system is turned off via operation line it remain on standby (filled and heated). Therefore it is immediately available after turning on.

The preset temperature and humidity values should be situated within the optimum range (hatched range in the figures below). Only within this area will the chamber not be exposed to excessive moisture due to condensation.

In the short-term set points outside the optimum range can also be targeted. The control accuracies of $\pm 3\%$ r.h., however, cannot be guaranteed in this case.

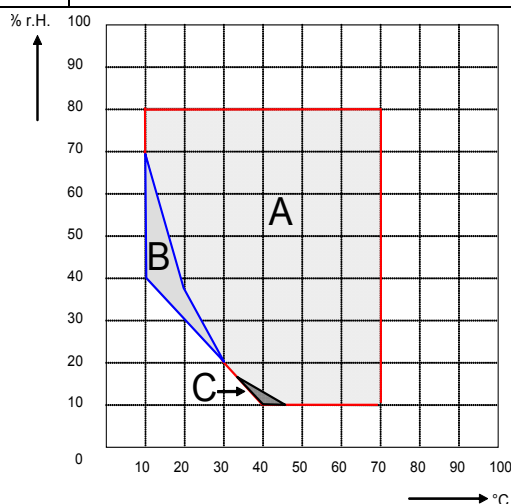

Chambers without light cassettes

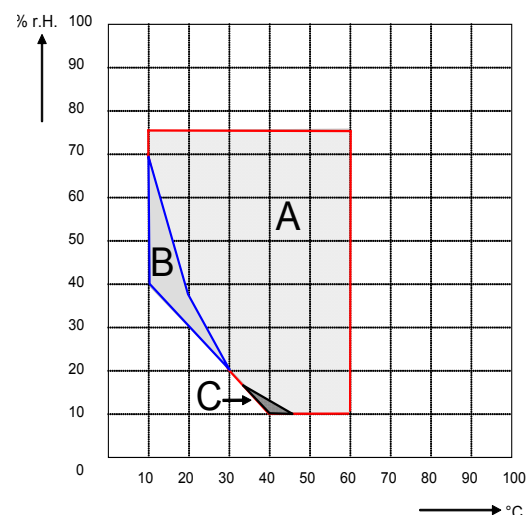

Chambers size 240 with illumination

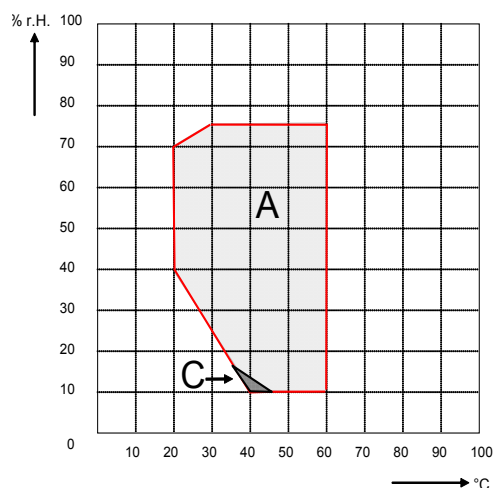

Chambers size 720 with illumination

Figure 23: Temperature-humidity diagrams

Range A: Control range of temperature and relative humidity, condensation free range

Range B: Discontinuous range (no continuous operation, up to 24 h)

Range C: In this range, condensation in the inner chamber is possible



Heat emission of electrical devices connected inside the chamber may modify the temperature and humidity range.

The chambers are equipped with a door heating system to prevent condensation in the door area.

If the set points for temperature or humidity are outside the optimum range, condensation can arise in the door area. Operating the chamber at humidity values > 70 % r.h. for a long period may lead to corrosion on the housing.



NOTICE

Danger of corrosion on the housing due to condensation by excess humidity.

Damage to the chamber.

- Dry the chamber completely before shut-down:
 - Set the humidity to 0 % r.h. The humidity system must be activated.
 - Set the temperature set point to 60 °C / 140 °F for approx. 2 hours (Manual mode).
 - Only then, shut down the chamber at the main power switch (1) and close the water supply tap.



Having turned off the chamber by the main power switch (1), always close the water supply tap.

If you operate the chamber at high humidity and then immediately turn off the chamber, the internal wastewater collector may overflow due to the condensate. This may lead to the emergence of water at the chamber.



NOTICE

Danger of water emerging at the chamber due to the overflow of the internal wastewater tank by condensate.

Damage to the surroundings of the chamber.

- ⊘ Following high humidity operation, do NOT directly turn off the chamber.
- Pump off the condensate before shut-down:
 - Set the humidity to 0 % r.h. The humidity system must be activated. Operate the chamber for at least 2 hours.
 - Only then, shut down the chamber at the main power switch (1) and close the water supply tap.

18.1 Function of the humidifying and dehumidifying system

Humidifying system

The humidifying and dehumidifying system is located in the humidity generation module. In a cylindrical container with a volume of about 2 liters an electrical resistance heating evaporates water. The water content is kept exactly at the boiling point, and thus steam can be immediately generated in sufficient quantity for rapid humidity increases or for compensation of humidity losses, e.g. by door openings. Condensation forming on the outer walls of the useable volume is led through a water drain in the outer chamber into the wastewater can which is pumped off automatically to the wastewater pipe when required.

Freshwater

You can supply the chamber with freshwater via a water pipe or by manually filling a freshwater can (option, chap. 21.9). You can mount the can on the rear of the chamber or place it next to the chamber.

	<p>In order to ensure accurate humidifying, observe the following points with regard to the freshwater supply:</p> <ul style="list-style-type: none"> • Supply pressure 1 to 10 bar when connecting to a water pipe • Water type: deionized (demineralized) water • To ensure humidification during 24 hours even at high humidity set-points with manual water supply, we recommend filling the freshwater can (option) at the end of each day. • Water intake temperature NOT below +5 °C / 41 °F and not exceeding 40 °C / 104 °F.
---	--

	<p>BINDER GmbH is NOT responsible for the water quality provided by the customer. Any problems and malfunctions that might arise following use of water of deviating quality is excluded from liability by BINDER GmbH.</p>
--	---

Automatic fresh water supply via water pipe

With this type of supply, the humidity system is continuously functional.

Manual fresh water supply via freshwater can (option, chap. 21.9)

With this type of supply, the humidity system is functional only if the water can is sufficiently filled. Check the filling level daily. The water reserve in the can is sufficient for a period, which may last between one and several days, depending on the humidity demand (entered humidity set-point and number of door openings).

Waste water

The condensation water from the interior is collected in an internal can with a volume of approx. 0.5 liters. It is pumped off via the waste water pipe.

Dehumidifying system

When the humidity system is activated, the chamber dehumidifies as needed in order to reach the entered humidity set-point inside the control range of temperature and relative humidity.

Dehumidification occurs in case of need by means of defined dew point undershoot of several evaporators of the refrigeration system. The condensate which forms is carried away as waste water.

If the humidity system is turned off while there are descending temperature curves, then operation of the refrigeration system may cause dehumidification of the charging material.

For error indications concerning water supply and humidity system, see chap. 12.1.4 and 23.5.

19. Defrosting at refrigerating operation

BINDER constant climate chambers are very diffusion-proof. To ensure high temperature precision there is no automatic cyclic defrosting device. The DCT™ refrigerating system largely avoids icing of the evaporation plates. However, at very low temperatures the moisture in the air can condense on the evaporator plates leading to icing.



Always close the door properly.

Operation with temperature set-points above +5 °C / 41 °F at an ambient temperature of 25 °C / 77 °F:

The air defrosts the ice cover automatically. Defrosting is continually performed.

Operation with temperature set-points below +5 °C / 41 °F:

Icing on the evaporator is possible. Defrost the chamber manually.



With temperature set-points < +5 °C / 41 °F, regularly defrost the chamber manually:

- Set the humidity to 0 % r.h. The humidity system must be activated.
- Set the temperature to 40 °C / 104 °F (in Fixed value entry mode).
- Let the chamber operate for approx. 30 minutes with the door closed.



Too much ice on the evaporator is noticeable by reduced refrigerating performance.

When turning off the chamber following prolonged refrigerating operation below +5 °C / 41 °F, there is danger of overflowing due to uncontrolled defrosting of icing on the evaporator.



NOTICE

**Danger of overflowing due to uncontrolled defrosting of icing on the evaporator.
Damage to the surroundings of the chamber.**

After several days of refrigerating operation below +5 °C / 41 °F:

- ⊘ Do NOT directly turn off the chamber.
- Manually defrost the chamber (see description above).
- Then, shut down the chamber at the main power switch (1) and close the tap of the water supply. Keep removed the access port plugs.

20. Illumination system

20.1 ICH compliant illumination according to CPMP/ICH/279/95 (Q1B) – KBF P / KBF P-UL, KBF LQC / KBF LQC-UL

Drugs are tested according to extensive test procedures and only thereafter are admitted for distribution. Part of the approval procedure is the proof that the products do not or only minimally change within the serviceable life. One of the tests to be executed is the photostability test according to ICH guideline Q1B. For this test, product samples must be exposed to a quantity of light of at least 1.2 million LUX x hours in constant climate chambers with ICH compliant illumination. To prove the quantity of light a temporal integration of illumination (LUX) and UV intensity (W/m²) e.g. by optical sensors is needed.



The KBF P / KBF P-UL and KBF LQC / KBF LQC-UL chambers are equipped with BINDER ICH light. Pure cool white fluorescent tubes (light color 965 Biolux) are used together with the special fluorescent tubes “BINDER Q1B Synergy Light” available only at BINDER, which combine emission of both radiations UVA and cool white. Combination of these tubes leads to a spectral distribution according to option 2 of Guideline CPMP/ICH/279/95 (Q1B).

Advantages of the BINDER light system:

- Reaching the radiation doses of UVA and LUX requested by Q1B almost simultaneously.
- After having reached the target intensity of guideline CPMP/ICH/279/95 (Q1B), you can turn off the “BINDER Q1B Synergy Light” fluorescent tubes, which contain a UVA portion, independently from the “cool white” fluorescent tubes emitting in the visible spectral range.
- Optimum homogeneity of the spectral distribution and the intensities in LUX and UVA on the shelf surface, even with high intensity values, obtained by the BINDER ICH light and the special lens of the headlight. This guarantees that all samples receive the same radiation doses, thus permitting very precise test conditions for photo stability tests.

Fluorescent tube cool white: T8 fluorescent tube in form of a rod with a tube diameter of 26mm. Length according to chamber size 600 mm / 23.6 in or 900 mm / 35.4 in. Emissive range in the visible spectral range 400 to 800 nm. The relative spectral distribution meets the F6 standard (cool white) acc. to ISO 10977.

Fluorescent tube “BINDER Q1B Synergy Light”: T8 fluorescent tube in the form of a rod with a tube diameter of 26 mm / 1.02 in. Length according to chamber size 600 mm / 23.6 in or 900 mm / 35.4 in. Emissive range in the visible spectral range 400 to 800 nm. Emissive range in the UVA range 320 to 400 nm.

	<div style="background-color: #FFA500; padding: 5px; text-align: center;">  WARNING </div> <p>Danger of eye and skin injury by UV light hazard. Eye and skin injury.</p> <ul style="list-style-type: none"> ⊘ Do NOT look directly into the light. ➤ Minimize skin exposure.
---	---

The maximum allowed ultraviolet exposure emitted by this chamber on unprotected skin or eye shall not exceed 7.7 hours per day.

The waste heat of the fluorescent tubes leads to a modification of the temperature - humidity diagram:

	<p>When operating the chamber with illumination: Restricted temperature and humidity range 20 °C / 68 °F to 60 °C / 140 °F , at 20 °C not below 30 % r.H.</p>
---	--

20.2 Illumination for optimal plant growth – KBWF

The KBWF chambers are equipped with day light fluorescent tubes. Optionally available are efficient FLUORA® growth illumination tubes for optimal plant growth or special Arabidopsis lamps. The fluorescent tubes are built in light cassettes.

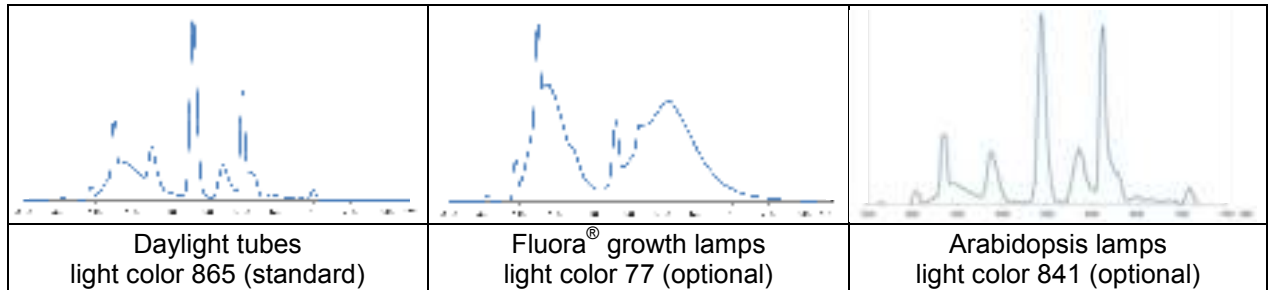

Figure 24: Spectral distribution of fluorescent tubes

Type of fluorescent tube: T8 fluorescent tube in form of a rod with a tube diameter of 26 mm / 1.02 in. Length according to chamber size: 600 mm / 23.6 in (KBWF 240), or 900 mm / 35.4 in (KBWF 720).

The waste heat of the fluorescent tubes leads to a modification of the temperature - humidity diagram:

	When operating the chamber with illumination: Restricted temperature and humidity range 20 °C / 68 °F to 60 °C / 140 °F , at 20 °C not below 30 % r.H.
--	---

20.3 Adjustable light cassettes

Special reflector material in the cassettes ensures optimum light diffusion and efficient utilization of the high light intensity. The lens of the headlight leads to a homogeneous intensity distribution even with a short distance to the shelf. The fluorescent tubes are built in light cassettes that can be freely positioned within wide areas. They homogeneously illuminate the racks below them.

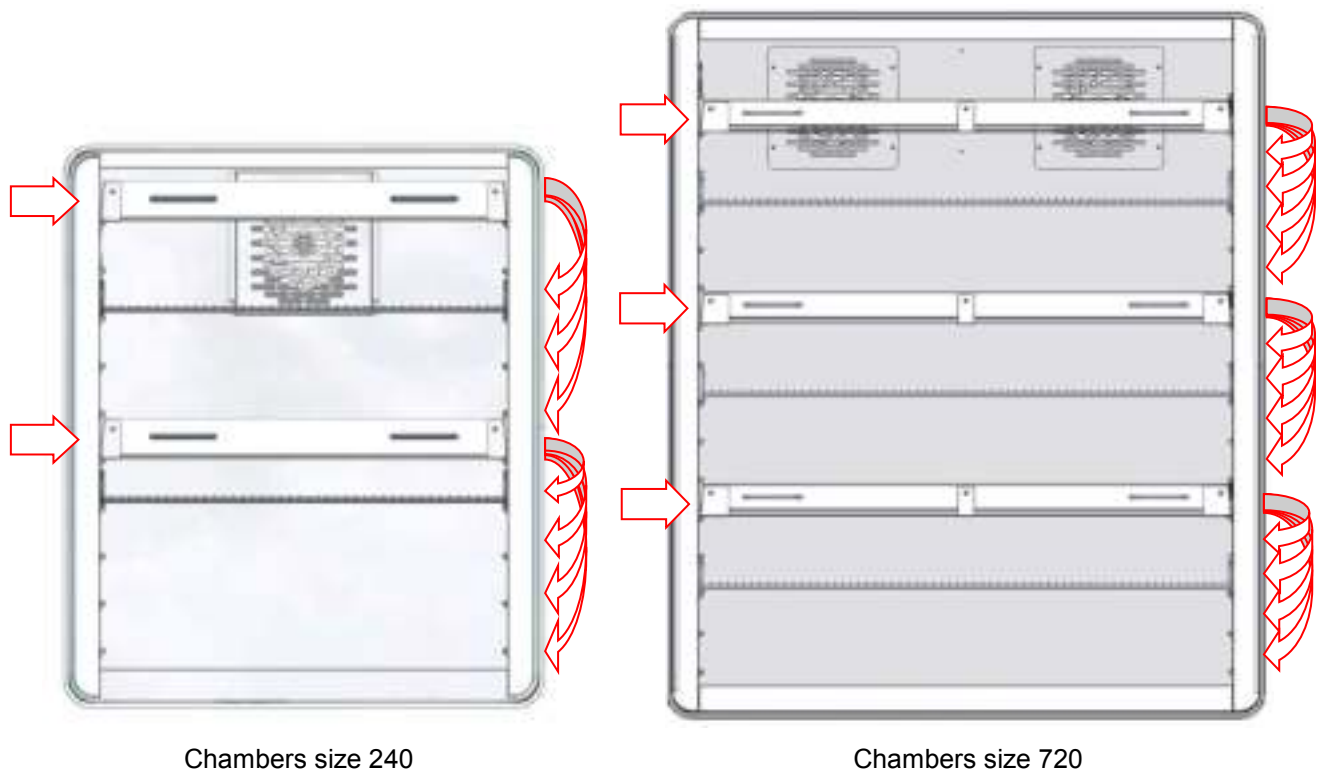
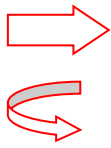

Figure 25: Positions of light cassettes



This position is only meant for the light cassettes. Due to their connections, shelves cannot be positioned here.

You can move the light cassettes to the indicated positions.

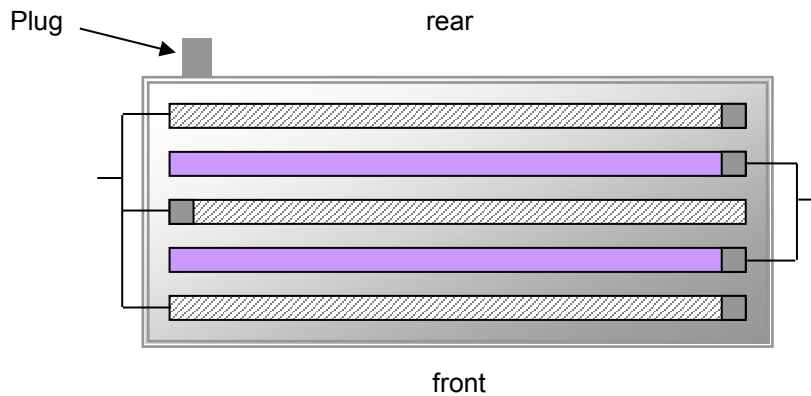

Figure 26: Arrangement of the fluorescent tubes in the light cassette of KBF P / KBF P-UL, KBF LQC / KBF LQC-UL

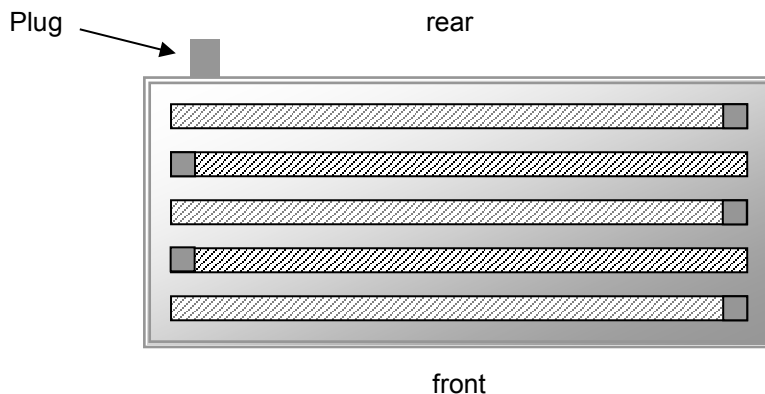

Figure 27: Arrangement of the fluorescent tubes in the light cassette of KBWF

You will obtain optimum homogeneity by alternately placing the fluorescent tubes of the same type, i.e., opposite arrangement of the inscription:



Figure 28: Opposite arrangement of two fluorescent tubes



When replacing the fluorescent tubes, observe tube orientation (inscription).

How to replace the fluorescent tubes is described in chap.23.3.



Operation with light cassettes and illumination on: Maximum temperature 60 °C / 140 °F.
 Operation with light cassettes and illumination off: Do also NOT operate the chamber at temperatures >60 °C / 140 °F. Otherwise, the lifetime of the fluorescent tubes will be considerably reduced.
 When operating the chamber at temperatures > 60 °C / 140 °F, remove the light cassettes.

20.4 Illumination control

The fluorescent tubes can be turned on and off with the operation lines of the program controller.

For activating the operating contacts please see chap. 8.4, 10.7.3, and 11.6.5.

KBF LQC / KBF LQC-UL: The fluorescent tubes can be turned on by entering a dose set-point value in Manual Mode higher than a dose value already reached. In Manual Mode the fluorescent tubes automatically turn off when the respective dose target value is reached. The operation lines permit turning on the fluorescent tubes independently from that value or to prevent automatic turning off. This enables attaining dose values, which lie above the entered maximum dose.

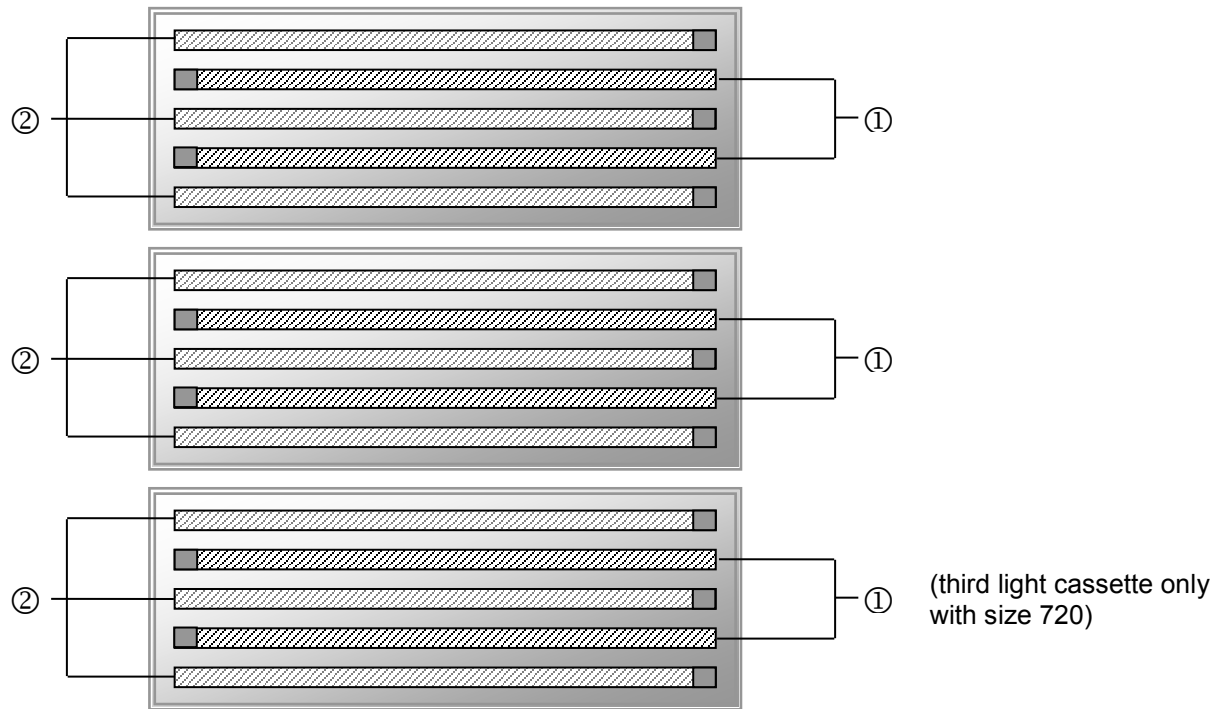



Figure 29: Control of fluorescent tubes in the light cassettes

- ① Control via operation line "Light Level 1" (KBWF) or "Light UVA" (KBF P / KBF P-UL, KBF LQC / KBF LQC-UL)
- ② Control via operation line "Light Level 2" (KBWF) or "Light VIS" (KBF P / KBF P-UL, KBF LQC / KBF LQC-UL)

By switching the operation lines therefore the following intensities can be obtained:

	Operation line "Light Level 1" Off, operation line "Light Level 2" Off	0 % illumination
①	Operation line "Light Level 1" On, operation line "Light Level 2" Off	40 % illumination
②	Operation line "Light Level 1" Off, operation line "Light Level 2" On	60 % illumination
① ②	Operation line "Light Level 1" On, operation line "Light Level 2" On	100 % illumination

The waste heat of the fluorescent tubes leads to a modification of the temperature - humidity diagram:

	When operating the chamber with illumination: Restricted temperature and humidity range 20 °C / 68 °F to 60 °C / 140 °F, at 20 °C not below 30 % r.h.
---	---

Note: When operating the chamber without illumination, there is an automatic correction of the actual temperature and humidity values when turning on or off the illumination (chap. 8.3).

20.5 Characteristic features of the light sensors – KBF LQC / KBF LQC-UL

The sensors can be plugged inside the inner chamber what makes it easy to take them out for calibration or replacement.

The intensities of illumination [LUX] and UV [W/m^2] are measured by optical sensors inside chambers with ICH illumination equipment (actual value display) and are temporally integrated (dose value display).

20.5.1 LUX sensor

Spectral sensitivity and spectral range are automatically determined with the unit “LUX”. The relative spectral sensitivity is the $V-\lambda$ distribution according to the sensitivity characteristics of the human eye.

- Display of the actual value in kLUX
- Display of the dose: The value “1” equals an integrated illumination of 1 MLUXh. Therefore values from 0 to 999.9 MLUXh can be displayed on a four-place display (0-999.9). A controller value of 1.2 equals 1.2 Mio. LUXh. With e.g., 11 kLUX it will therefore take the dose display about 9 hours to increase by 0.1.

20.5.2 UVA sensor

The UVA sensors must take into account the spectral range between 320 and 400 nm, which is defined in ICH guideline Q1B, Option 2.

- Display of the actual value in W/m^2
- Display of the dose: The value 1 equals an integrated illumination 1 Wh/m^2 (equaling 0.36 J/cm^2). Therefore values from 0 to 999.9 Wh/m^2 can be displayed on a four-place display (0-999.9). A controller value of 200.0 equals 200.0 Wh/m^2 . With e.g., 7 W/m^2 it will therefore take the display unit about 8.6 minutes to increase by 0.1.

20.5.3 Spectral range

The spectral sensitivities of both sensors are adapted to the spectral ranges defined in the ICH guideline Q1B, Option 2.

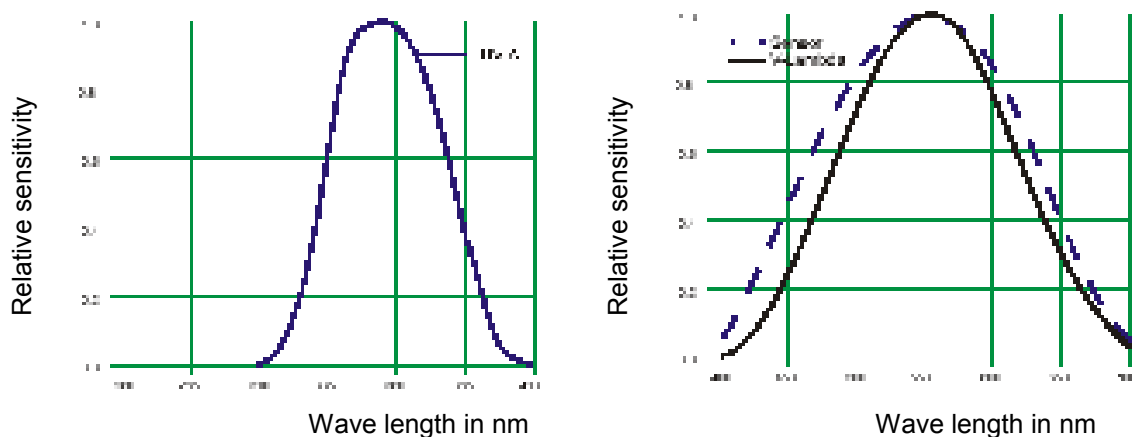

Figure 30: Relative spectral sensitivities

20.5.4 Spatial sensitivity

Spherical sensors are used for UVA and the visible spectral range.

Thus, the spatial sensitivity of the detectors is adapted to the spatial effect of radiation in relation to the photochemical effect to be weighted in the charging material. Due to the spatial extension of the sample, the real impinging radiation dose can be determined much more realistic than with planar (cosine adapted) sensors.

Characteristic features of spherical sensors

Compared to planar (cosine adapted) sensors, spherical sensors measure largely independent of direction. They are suitable for all samples with spatial extension and spatially distributed objects (e.g. bottles and other vessels, pills, dissolved substances). Here, the radiation intensity or illumination really entering the sample can be realistically determined with spherically measuring light sensors. The energy entering the sample in the visible, and UV range is thus weighted in optimal approximation to its real photochemical effects.

Use of planar sensors with spatial objects leads to underrating of the radiation energy, leading to excessive exposure duration and possible false positive photochemical effects. The ICH guideline Q1B proposes actinometric systems in glass ampoules as a reference for exposition to radiation; the photochemical effect to a defined test solution caused by radiation exposure is photometrically determined. Here, the photochemical effect is determined independent of direction using a liquid in an ampoule. The use of the spherical sensors in the BINDER measurement system imitates this quantification of the photochemically effective radiation in the best approximation. It enables and permits an exposition exactly responding to the demands of ICH guideline Q1B.

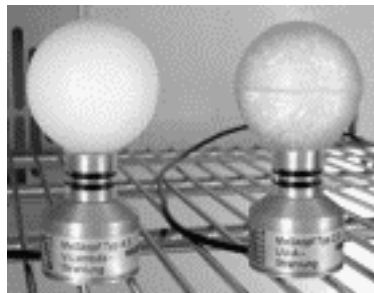
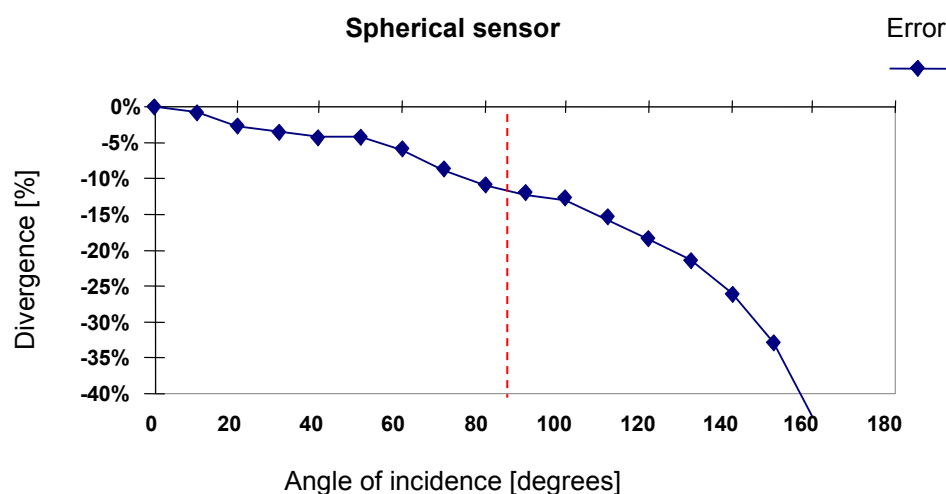

Figure 31: Spherical BINDER sensors for VIS, and UVA measurement



Radiation in a range of +/- 100° around the 90° axis of incidence is weighted almost equally with a factor between 1.0 and 0.9. Only with greater angles, weighting of the radiation decreases, technically caused by the sensor foot.

Comparison of different sensor types

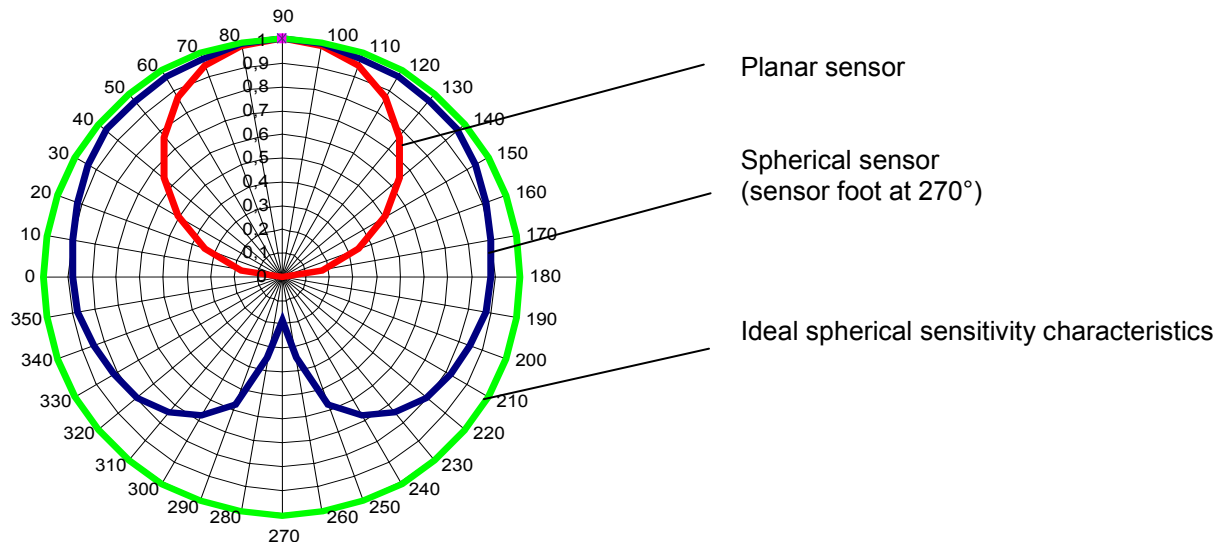
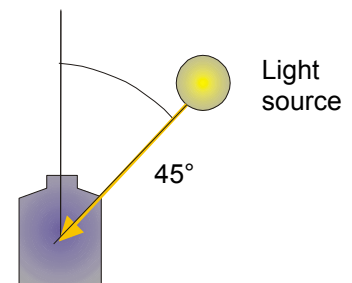



Figure 32: Comparison of the spatial sensitivity characteristics of planar and spherical sensors

If a sample is irradiated with light at an angle of incidence of 45°, the spherical sensor assumes the impinging light quantity as large as the amount of light that would impinge with vertical irradiation (factor 1). Since this is true for a sample with spatial extension, the error is zero in this case.

A planar sensor instead would take into account the cosine of the angle of incidence: $\cos 45 = 0.71$. But due to the spatial extension of the sample, no correction is necessary. The planar sensor therefore calculates the amount of light which impinges on the sample by a factor of 0.71 less than the light quantity that would impinge with vertical irradiation. Thus, the light really impinging on the sample surface will be calculated only at 71% of the real value.

Deviation from the vertical: 0°



 In case of exclusive use of entirely flat samples without spatial extension (e.g. spreaded samples, film), an overrating of the light which really impinges on the plane surface is possible. Please contact BINDER INDIVIDUAL customized solutions.

 If an independent reference measuring device shall be used to directly compare the light intensities, it must bear the same spatial sensitivity characteristics (spherical) as the sensors of the BINDER system.

21. Options

21.1 APT-COM™ 4 Multi Management Software (option)

The chamber is regularly equipped with an Ethernet interface (4) that can connect the BINDER APT-COM™ 4 Multi Management Software. The MAC Address is indicated in the “Device info” controller menu (chap. 15.5.2.2). The actual temperature and humidity values are given at adjustable intervals. Programming can be performed graphically via PC. Up to 100 chambers can be cross-linked. For further information on networking please refer to the APT-COM™ 4 operating manual.

KBF LQC / KBF LQC-UL: The integrated values of VIS and UVA light are documented GLP/GMP compliant by the APT-COM™ 4 software. The documentation of these light values takes place under the same preconditions regarding 21CFR11 as the documentation of temperature and humidity. The user thus receives an overall solution perfectly adapted to his chamber.

KBF P / KBF P-UL / KBF LQC / KBF LQC-UL: APT-COM™ 4 Basic Edition is included with the chamber. APT-COM™ 4 is available for download on the BINDER website. Upon registering the chamber, you will receive a license key with which you can activate the functionality of the Basic Edition for your downloaded version. For further information see chap. 27.2.

21.2 RS485 interface (option)

With this option, the chamber is equipped with an additional 2-wire RS485 serial interface (7) that can connect the BINDER APT-COM™ 4 Multi Management Software. The actual temperature and humidity values are given at adjustable intervals. For further information, please refer to the APT-COM™ 4 operating manual.

21.3 Data logger kits (option)

BINDER Data Logger Kits offer an independent long-term measuring system for temperature and humidity, available for different temperature ranges. According to the selected kit, the Data Logger can measure and record also the ambient temperature and humidity values via a second multi-function sensor.

BINDER Data Loggers are equipped with a keyboard and a large LCD display, alarm functions and a real-time function. Measurement data are recorded in the Data Logger and can be read out after the measurement via the RS232 interface of the Data Logger. It offers a programmable measuring interval and permits storing up to 64000 measuring values. Reading out is done with the Data Logger evaluation software. You can give out a combined alarm and status protocol directly to a serial printer.

Data Logger Kit TH 70: Multi-function sensor for chamber temperature and humidity: Temperature range $-40\text{ °C} / -40\text{ °F}$ up to $70\text{ °C} / 158\text{ °F}$, humidity range 0% r.h. up to 100% r.h.

Data Logger Kit TH 70/70: Multi-function sensor for chamber temperature and humidity: Temperature range $-40\text{ °C} / -40\text{ °F}$ up to $70\text{ °C} / 158\text{ °F}$, humidity range 0% r.h. up to 100% r.h. Multi-function sensor for ambient temperature and humidity: Temperature range $-40\text{ °C} / -40\text{ °F}$ up to $70\text{ °C} / 158\text{ °F}$, humidity range 0% r.h. up to 100% r.h.



For detailed information on installation and operation of the BINDER Data Logger, please refer to the mounting instructions Art. No. 7001-0204 and to the original user manual of the manufacturer, supplied with the data logger.

21.4 Analog outputs for temperature and humidity (option)

With this option the chamber is equipped with analog outputs 4-20 mA for temperature and humidity. These outputs allow transmitting data to external data registration systems or devices.

The connection is realized as a DIN socket (3) in the right lateral control panel as follows:

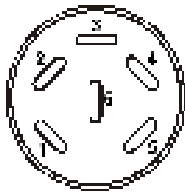

ANALOG OUTPUT 4-20 mA DC

PIN 1: Temperature –

PIN 2: Temperature +

PIN 3: Humidity –

PIN 4: Humidity +

Temperature range: -10 °C / 14 °F to +100 °C / 212 °F

Humidity range: 0 % r.h. to 100 % r.h.

A suitable DIN plug is enclosed.

Figure 33: Pin allocation of DIN socket (3) for option analog outputs

21.5 Zero-voltage relay alarm outputs for temperature and humidity (option)

The chamber equipment with optional zero-voltage relay outputs for temperature and humidity (option) permits the transmission of alarms to a central monitoring system. Connection is established via a DIN socket (6) located on the right lateral control panel.

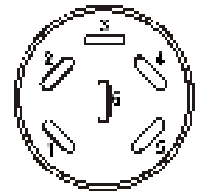



Figure 34: Pin configuration of the DIN socket (6)

Temperature contact	Humidity contact
 <p>Pin 1: Pin Pin 2: Make</p>	 <p>Pin 3: Pol Pin 4: Make</p>

In case of a temperature alarm, pins 1 and 2 are open; with humidity alarm, pins 3 and 4 are open. This happens simultaneously with the alarm message shown on the controller display.

In case of power failure, both contacts are open.

Maximum loading capacity of the switching contacts: 24V AC/DC - 2,5A

	 DANGER
	<p>Electrical hazard through overload of contacts. Deadly electric shock. Damage to the switching contacts and connection socket.</p> <ul style="list-style-type: none"> ⊘ Do NOT exceed the maximum switching load of 24V AC/DC – 2.5A. ⊘ Do NOT connect any devices with a higher loading capacity.

A temperature and humidity alarm message will remain visible on the controller display during the whole time of the alarm transmission via the zero-voltage relay outputs.

As soon as the cause of the alarm is rectified, you can reset the alarm transmission via the zero-voltage relay outputs together with the alarm message on the controller.

In case of power failure, transmission of the alarm via zero-voltage relay outputs remains active for the duration of the power failure. Afterwards, both contacts will close automatically.

	<p>When using the APT-COM™ 4 Multi Management Software (option, chap. 21.1) via the Ethernet interface of the chamber for data acquisition, the alarm is not automatically transmitted to the APT-COM™ protocol.</p> <p>➤ Set the tolerance limits for recording limit value excesses separately in APT-COM™ 4.</p>
--	---

21.6 Water protected internal socket (option)

The internal socket is splash proof.

IP system of protection 67 230 V 1N ~ 50-60 Hz

Charge max. 500 W

The maximum operating temperature with this option is 90 °C / 194 °F.

	<p>Heat emission of electrical devices connected inside the chamber may modify the temperature and humidity range.</p>
--	--

	NOTICE
	<p>Risk of short circuit caused by penetration of moisture into the socket. Damage to the chamber.</p> <p>➤ Use the supplied plug only (IP protection type 67). Plug it in and tighten it by screwing to secure contact.</p> <p>➤ If the socket is not used, close the screw lid and turn it to secure.</p>

21.7 Additional flexible Pt 100 temperature sensor (available via BINDER INDIVIDUAL customized solutions)

An additional flexible temperature sensor Pt100 allows measuring the temperature of the charging material by means of an independent measuring system utilizing Pt 100 entry. The Pt 100 sensor's top protective tube can be immersed into liquid substances.

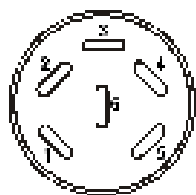

Pt 100 Sensor

- PIN 1: Pt 100
- PIN 2: Pt 100
- PIN 3: Pt 100

A suitable DIN plug is enclosed.

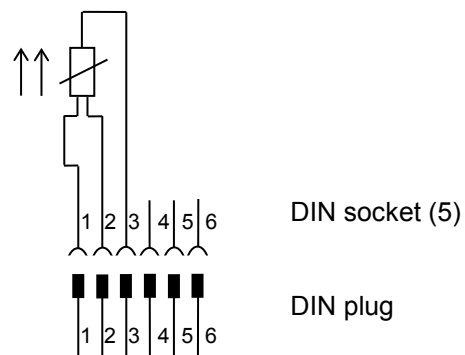

Figure 35: Pin configuration of the DIN socket (5) in the right lateral control panel

Technical data of the Pt100 sensor:

- Three-wire technique
- Class B (DIN EN 60751)
- Temperature range up to 320 °C / 608 °F
- Stainless steel protective tube with a length of 45 mm / 1.78 in, material no. 1.4501

21.8 Object temperature display with flexible Pt 100 temperature sensor (option)

The object temperature display enables the determination of the actual temperature of the charging material during the whole process. The object temperature is measured via a flexible Pt100 temperature sensor and can be viewed on the controller display. You can immerse the sensor top protective tube of the flexible Pt 100 into liquid substances.

TEMPERATURE		Setpoint	actual value
Temperature	°C	10.0	11.1
Humidity	%RH	90.0	98.1
Obj. Temp.	°C		10.6

Normal display with object temperature display (sample values)

The object temperature data are put out together with the data of the temperature controller and can be documented by the APT-COM™ 4 Multi Management Software (option, chap. 21.1) developed by BINDER.

Technical data of the Pt100 sensor:

- Three-wire technique
- Class B (DIN EN 60751)
- Temperature range up to 320 °C / 608°F
- Stainless steel protective tube with a length of 45 mm / 1.78 in, material no. 1.4501

21.9 External freshwater and wastewater cans (option)

If no suitable in-house water connection is available, you can manually supply water by filling the optional external freshwater can. There is an additional external water can for the waste water. Volume: 20 liters / 0.71 cu.ft.

The cans are placed in holding devices. You can affix them directly at the rear of the chamber or place them next to the chamber.

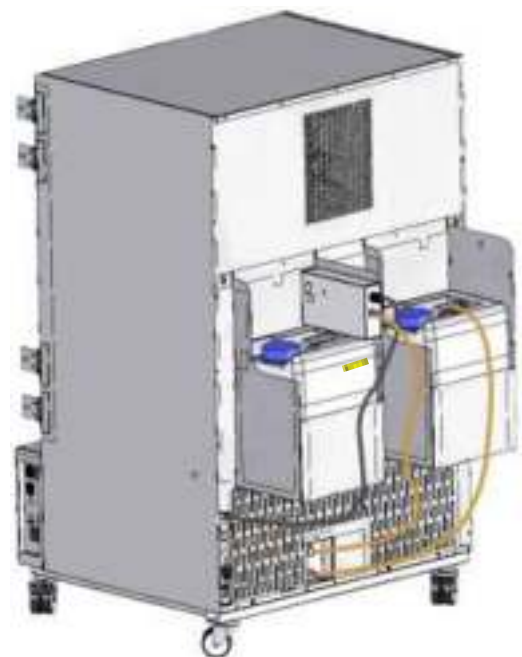

Figure 36: Rear chamber view with installed external water cans (option)

21.9.1 Mounting the freshwater can

(1) Fixing (if required)

Hang the can with its holding device on its 4 carriers. You can install it either at the left or the right side.

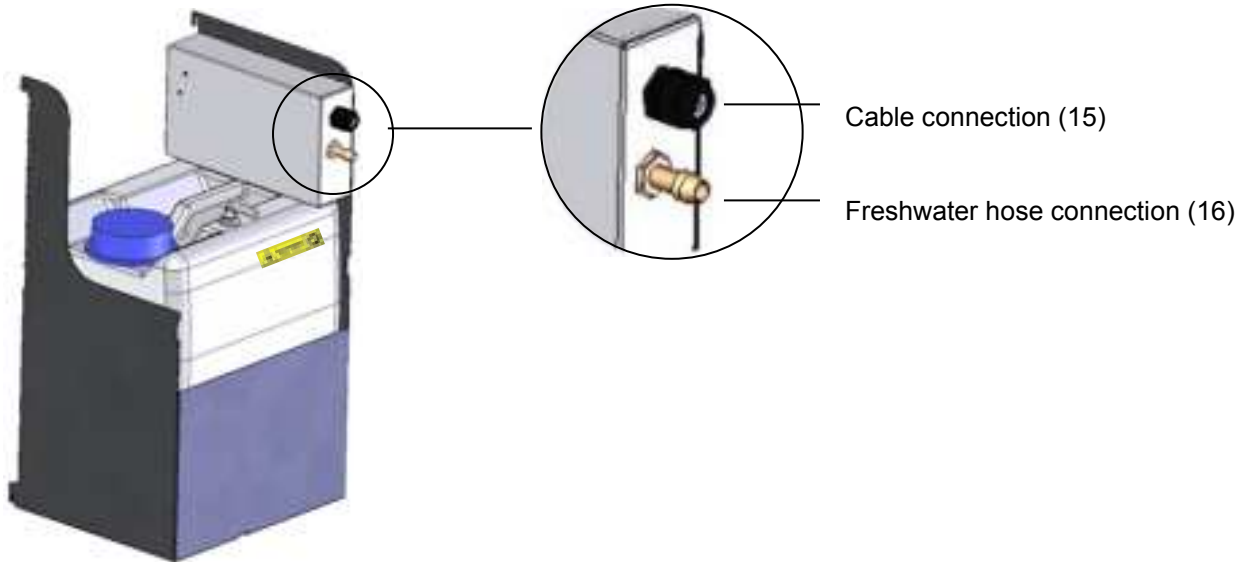

Figure 37: Freshwater can (option)

(2) Cable connections

Connect the plug of the cable to the socket (10) at the rear of the chamber.

The socket (10) is marked with a sticker:

**WATER TANK
24 VDC/MAX 0.2A**

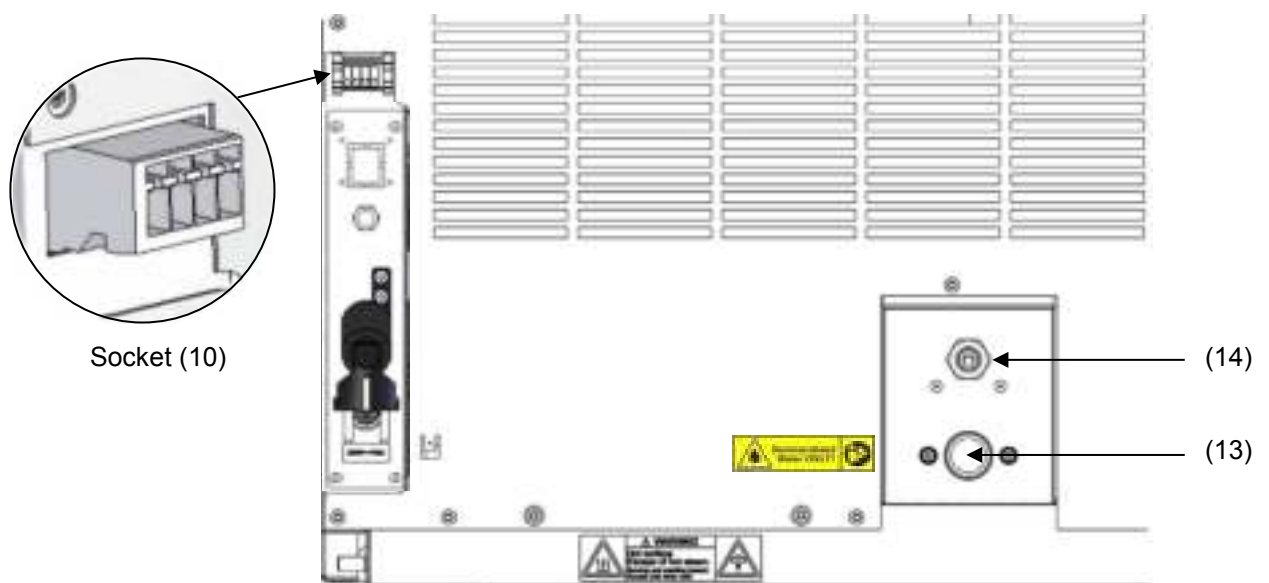

Figure 38: Connections at the chamber rear

(3) Hose connections

Plug the freshwater hose into the hose connection (16) above the freshwater can and secure it with a hose clamp. You can use a part of the standard supplied water hose.

Screw the hose nozzle (brass) to the free edge of the hose and screw it directly onto the freshwater connection "IN" (13) at the rear of the chamber.

When the freshwater can is empty, the message "Freshwater supply" will be displayed on the controller (chap. 12.1.4), the buzzer sounds, and the humidification module turns off. After acknowledging the alarm, the humidification module tries to fill up and start operating.



To guarantee humidification during 24 hours even at high humidity set-points with manual water supply, we recommend filling the freshwater can (option) at the end of each day.

21.9.2 Mounting the wastewater can

(1) Fixing (if required)

Hang the can with its holding device on its 4 carriers at the free space next to the freshwater can.

(2) Hose connections

Plug the wastewater hose to the hose connection (17) of the wastewater can and secure it with a hose clamp. You can use a part of the standard supplied water hose.

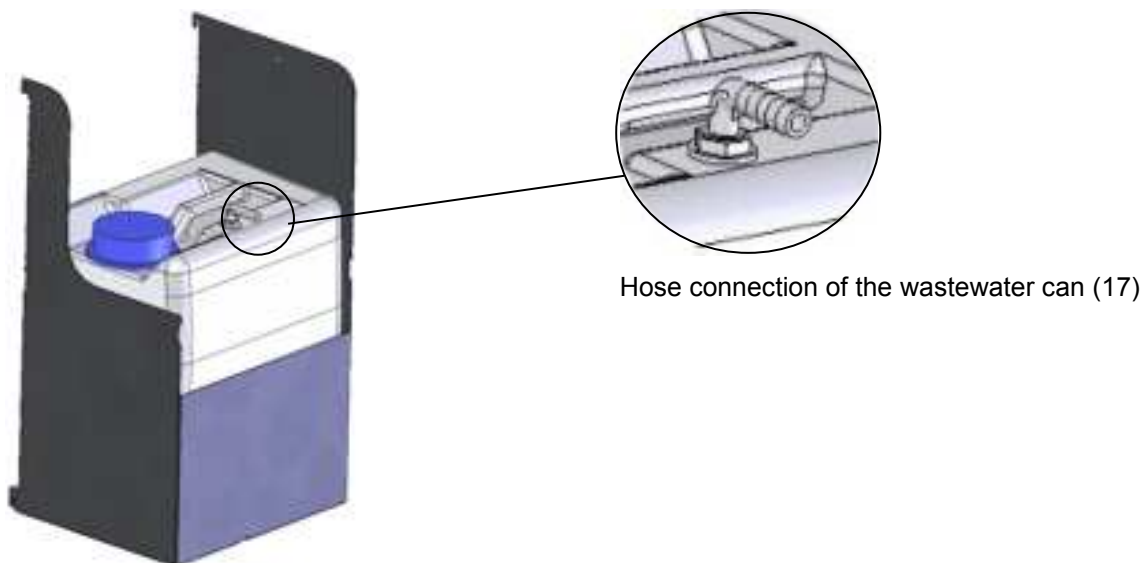



Figure 39: Wastewater can (option)

Plug the free hose edge to the wastewater connection "OUT" (14) at the rear of the chamber and secure it with a hose clamp.

Disconnect the hose for emptying the wastewater can. Then you can remove the wastewater can together with its holding device for emptying.

	NOTICE
	<p>Danger of overflow of the wastewater can. Damage to the surroundings of the chamber.</p> <ul style="list-style-type: none"> ➤ Regularly check the filling level of the wastewater can. ➤ Always empty the wastewater can in a timely manner before it is full.

	<p>Bringing a source of humidity into the inner chamber may increase wastewater production. Regularly check the filling level of the wastewater can.</p>
---	--

21.9.3 Mounting with wastewater recycling

When the chamber interior is clean, you can reuse the wastewater from the chamber. Connect the wastewater connection “OUT” (14) of the chamber with the freshwater hose connection (18) of the freshwater can. The wastewater can is not used in this case.

	NOTICE
	<p>Danger of soiling of the vapor humidification system. Damage to the chamber.</p> <ul style="list-style-type: none"> ➤ Reuse wastewater ONLY with a clean chamber interior. ➤ In case of soiling / contamination of the interior, conduct the wastewater to the wastewater connection or use the wastewater can.

	<p>BINDER GmbH is NOT responsible for the water quality at the user’s site, especially when reusing wastewater. Any problems and malfunctions that might arise following use of wastewater are excluded from liability by BINDER GmbH.</p>
---	---

(1) Fixing of the freshwater can (if required)

Hang the can with its holding device on its 4 carriers. You can install it either at the left or the right side.

(2) Cable connections of the freshwater can

Connect the plug of the cable to the socket (10) at the rear of the chamber as described in chap. 21.9.1.

(3) Hose connections

Plug the wastewater hose into the hose connection (18) of the freshwater can and secure it with a hose clamp. You can use a part of the standard supplied water hose.

Plug the free hose edge to the wastewater connection “OUT” (14) at the rear of the chamber and secure it with a hose clamp.

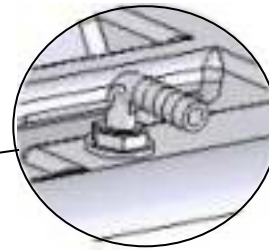

Hose connection of the freshwater can (18)

Figure 40: Freshwater can (option)



Bringing a source of humidity into the inner chamber may increase wastewater production. Regularly check the filling level of the freshwater can.

21.10 BINDER Pure Aqua Service (option)

The optional BINDER water treatment system (disposable system) is available to treat tap water. The lifetime depends on water quality and the amount of treated water used. The measuring equipment to assess the water quality is reusable.





For detailed information on operating the water treatment system BINDER Pure Aqua Service and its function, please refer to the operating manual supplied with BINDER Pure Aqua Service.

22. Cleaning and decontamination

Clean the chamber after each use in order to prevent potential corrosion damage by ingredients of the loading material.

Prior to renewed startup, allow the chamber to completely dry after all cleaning and decontamination measures.

	 DANGER
	<p>Electrical hazard by water entering the chamber. Deadly electric shock.</p> <ul style="list-style-type: none"> ∅ Do NOT spill water or cleaning agents over the inner and outer chamber surfaces. ∅ Do NOT put ANY cleaning aids (cloth or brush) into slots or openings on the chamber. ➤ Before cleaning, turn off the chamber at the main power switch and disconnect the power plug. Let the chamber cool down to ambient temperature. ➤ Completely dry the chamber before turning it on again.

22.1 Cleaning

Disconnect the chamber from the power supply before cleaning. Disconnect the power plug.

	The interior of the chamber must be kept clean. Thoroughly remove any residues of test material.
---	--

Wipe the surfaces with a moistened towel. In addition, you can use the following cleaning agents:

Exterior surfaces inner chamber racks door gaskets	Standard commercial cleaning detergents free from acid or halides. Alcohol-based solutions. We recommend using the neutral cleaning agent Art. No. 1002-0016.
Instrument panel	Standard commercial cleaning detergents free from acid or halides. We recommend using the neutral cleaning agent Art. No. 1002-0016.
<i>KBF LQC / KBF LQC-UL</i> : Light sensors	Wipe with a soft, if desired moistened towel. Do not mechanically strain the light sensors during cleaning and take care not to scratch them.
Zinc coated hinge parts rear chamber wall	Standard commercial cleaning detergents free from acid or halides. Do NOT use a neutral cleaning agent on zinc coated surfaces.

Do not use cleaning agents that may cause a hazard due to reaction with components of the device or the charging material. If there is doubt regarding the suitability of cleaning products, please contact BINDER service.

	<p>We recommend using the neutral cleaning agent Art. No. 1002-0016 for a thorough cleaning.</p> <p>Any corrosive damage that may arise following use of other cleaning agents is excluded from liability by BINDER GmbH.</p> <p>Any corrosive damage caused by a lack of cleaning, is excluded from liability by BINDER GmbH.</p>
---	--

	NOTICE
	<p>Danger of corrosion by using unsuitable cleaners. Damage to the chamber.</p> <ul style="list-style-type: none"> ∅ Do NOT use acidic or chlorine cleaning detergents. ∅ Do NOT use a neutral cleaning agent on other kind of surfaces e.g., the zinc coated hinge parts or the rear chamber wall.

	<p>For surface protection, perform cleaning as quickly as possible. After cleaning completely remove cleaning agents from the surfaces with a moistened towel. Let the chamber dry.</p>
---	---



	<p>Soapsuds may contain chlorides and must therefore NOT be used for cleaning.</p>
---	--

	<p>With every cleaning method, always use adequate personal safety controls.</p>
---	--

Following cleaning, leave the chamber door open or remove the access port plugs.

	<p>The neutral cleaning agent may cause health problems in contact with skin and if ingested. Follow the operating instructions and safety hints labeled on the bottle of the neutral cleaning agent.</p>
--	--

Recommended precautions: To protect the eyes use sealed protective goggles. Wear gloves. Suitable protective gloves with full contact: butyl or nitrile rubber, penetration time >480 minutes.

	 CAUTION
	<p>Danger of chemical burns through contact with skin or ingestion of the neutral cleaning agent. Skin and eye damage. Environmental damage.</p> <ul style="list-style-type: none"> ∅ Do not ingest the neutral cleaning agent. Keep it away from food and beverages. ∅ Do NOT empty the neutral cleaning agent into drains. ➤ Wear protective gloves and goggles. ➤ Avoid skin contact with the neutral cleaning agent.

22.2 Decontamination / chemical disinfection

The operator must ensure that proper decontamination is performed in case a contamination of the chamber by hazardous substances has occurred.

Disconnect the chamber from the power supply prior to chemical decontamination. Pull the power plug.

Do not use decontamination agents that may cause a hazard due to reaction with components of the device or the charging material. If there is doubt regarding the suitability of cleaning products, please contact BINDER service.

You can use the following disinfectants:

Inner chamber	Standard commercial surface disinfectants free from acid or halides. Alcohol-based solutions. We recommend using the disinfectant spray Art. No. 1002-0022.
---------------	---

	For chemical disinfection, we recommend using the disinfectant spray Art. No. 1002-0022. Any corrosive damage that may arise following use of other disinfectants is excluded from liability by BINDER GmbH.
---	--



	With every decontamination / disinfection method, always use adequate personal safety controls.
---	---

In case of contamination of the interior by biologically or chemically hazardous material, there are two possible procedures depending on the type of contamination and charging material:

1. Spray the inner chamber with an appropriate disinfectant.
Before start-up, the chamber must be absolutely dry and ventilated, as explosive gases may form during the decontamination process.
2. If necessary, have strongly contaminated inner chamber parts removed by an engineer for cleaning, or have them exchanged. Sterilize the inner chamber parts in a sterilizer or autoclave.

	In case of eye contact, the disinfectant spray may cause eye damage due to chemical burns. Follow the operating instructions and safety hints labeled on the bottle of the disinfectant spray.
--	--

Recommended precautions: To protect the eyes use sealed protective goggles.

	<div style="background-color: yellow; text-align: center; padding: 5px;"> CAUTION</div> <p>Danger of chemical burns through eye contact with the disinfectant spray. Eye damage. Environmental damage</p> <ul style="list-style-type: none"> ⊘ Do NOT empty the disinfectant into drains. ➤ Wear protective goggles.
---	--

	After using the disinfectant spray, allow the chamber to dry thoroughly, and aerate it sufficiently.
---	--

23. Maintenance and service, troubleshooting, repair, testing

23.1 General information, personnel qualification

- **Maintenance**

See chap. 23.2

- **Simple troubleshooting**

Chap. 23.5 describes troubleshooting by operating personnel. It does not require technical intervention into the chamber, nor disassembly of chamber parts.

For personnel requirements please refer to chap. 1.1.

- **Detailed troubleshooting**

If errors cannot be identified with simple troubleshooting, further troubleshooting must be performed by BINDER Service or by BINDER qualified service partners or technicians, in accordance with the description in the Service Manual.

For personnel requirements please refer to the Service Manual.

- **Repair**

Repair of the chamber can be performed by BINDER Service or by BINDER qualified service partners or technicians, in accordance with the description in the Service Manual.



After maintenance, the chamber must be tested prior to resuming operation.

- **Electrical testing**

To prevent the risk of electrical shock from the electrical equipment of the chamber, an annual repeat inspection as well as a test prior to initial startup and prior to resuming operation after maintenance or repair, are required. This test must meet the requirements of the competent public authorities. We recommend testing under DIN VDE 0701-0702:2008 in accordance with the details in the Service Manual.

For personnel requirements please refer to the Service Manual.

23.2 Maintenance intervals, service

 	 DANGER
	<p>Electrical hazard during live maintenance work. Deadly electric shock.</p> <ul style="list-style-type: none"> Ø The chamber must NOT become wet during operation or maintenance works. Ø Do NOT remove the rear panel of the chamber. ➤ Disconnect the chamber before conducting maintenance work. Turn off the main power switch and pull the power plug. ➤ Make sure that general maintenance work will be conducted by licensed electricians or experts authorized by BINDER. ➤ Make sure that maintenance work at the refrigeration system will only be conducted by qualified personnel who underwent training in accordance with EN 13313:2010 (e.g. a refrigeration technician with certified expert knowledge acc. to Regulation (EC) n° 303/2008). Follow the national statutory regulations.

Ensure regular maintenance work is performed at least once a year and that the legal requirements are met regarding the qualifications of service personnel, scope of testing and documentation. All work on the refrigeration system (repairs, inspections) must be documented.



The warranty becomes void if maintenance work is conducted by non-authorized personnel.

Have conducted regular maintenance work on the steam humidifier at least once a year. The operating behavior and the maintenance intervals of the humidifier essentially depend on the available water quality and the amount of steam produced in the meantime.



We recommend cleaning the condensers at least twice a year. A qualified technician must perform cleaning.



Replace the door gasket only when cold. Otherwise, the door gasket may become damaged.

With an increased amount of dust in the ambient air, clean the condenser fan (by suction or blowing) several times a year.

We recommend taking out a maintenance agreement. Please consult BINDER Service:

BINDER telephone hotline:	+49 (0) 7462 2005 555
BINDER fax hotline:	+49 (0) 7462 2005 93555
BINDER e-mail hotline:	service@binder-world.com
BINDER service hotline USA:	+1 866 885 9794 or +1 631 224 4340 x3 (toll-free in the USA)
BINDER service hotline Asia Pacific:	+852 390 705 04 or +852 390 705 03
BINDER service hotline Russia and CIS:	+7 495 988 15 16
BINDER Internet website:	http://www.binder-world.com
BINDER address:	BINDER GmbH, post office box 102, 78502 Tuttlingen, Germany

International customers, please contact your local BINDER distributor.

After 8760 operating hours or two years the following message appears:

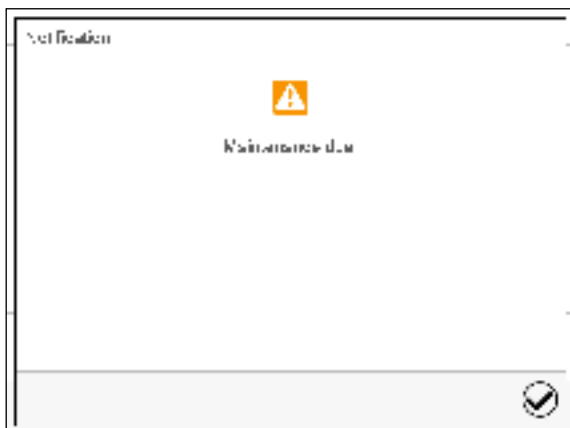

After confirmation with the **Confirm** icon, the message window will pop up again every two weeks until it is reset by BINDER Service.

23.3 Replacement of the fluorescent tubes

The average life expectancy of the fluorescent tubes is about 10,000 hours. We recommend replacing the tubes every year in order to ensure full light intensity.

To replace the fluorescent tubes, unscrew and remove the clamping strips resting against the glass plate (Allen screwdriver). Then lift the plate from the cassette. Rotate the tubes by 90° and pull them out of their holders. When setting in the new tubes, observe the tube orientation (inscription, Figure 26). Fix the glass plate and then screw in the clamping strips.

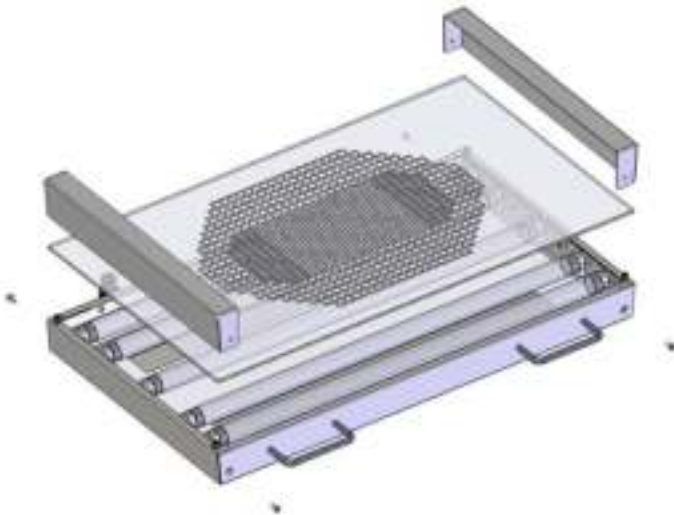

Figure 41: Dismounting a light cassette



Always replace all the fluorescent tubes of a light cassette together. Otherwise, homogeneity of light intensity cannot be ensured.

23.4 Calibrating the light sensors and adjusting the controller display – KBF LQC / KBF LQC-UL

The light sensors are supplied with a calibration certificate giving at least 2 measuring values with the related measuring current values.

For recalibrating the light sensors, send the sensors to BINDER factory service.



If an independent reference measuring device is used to directly compare the light intensities, it must bear the same spatial sensitivity characteristics (spherical) as the sensors of the BINDER system (chap. 20.5.4).

23.5 Simple troubleshooting

Defects and shortcomings can compromise the operational safety of the chamber and can lead to risks and damage to equipment and persons. If there is a technical fault or shortcoming, take the chamber out of operation and inform BINDER Service. If you are not sure whether there is a technical fault, proceed according to the following list. If you cannot clearly identify an error or there is a technical fault, please contact BINDER Service.



Only qualified service personnel authorized by BINDER must perform repair. Repaired chambers must comply with the BINDER quality standards.

Fault description	Possible cause	Required measures
General		
Chamber without function.	No power supply.	Check connection to power supply. Check whether the chamber is turned on at the main power switch.
	Wrong voltage.	Check power supply for correct voltage (chap. 4.6).
	Chamber fuse has responded.	Check chamber fuse and replace it if appropriate. If it responds again, contact BINDER service.
	Controller defective.	Contact BINDER service.
	Nominal temperature exceeded by 10° due to chamber failure. Over temperature protective device (class 1) responds.	
Heating		
Chamber heating permanently, set-point not maintained.	Controller defective.	Contact BINDER service.
	Semiconductor relay defective.	
Chamber doesn't heat up.	Controller not well adjusted, or adjustment interval exceeded.	Calibrate and adjust controller.
	Pt 100 sensor defective.	Contact BINDER service.
	Heating element defective.	
Chamber doesn't heat up when turned on. Safety controller responds.	Semiconductor relay defective	Contact BINDER service.
	Inner chamber temperature has reached the safety controller setpoint. Safety controller set too low.	
Mechanical safety device class 3.1 responds (with option safety device class 3.3).	Safety controller (chap. 13.2) defective.	Acknowledge the alarm on the controller. Check temperature setpoint setting. If appropriate, select suitable safety controller setpoint (chap. 13.2).
	Limit temperature reached.	Contact BINDER service.
	Too much external heat load.	Acknowledge the alarm on the controller. Check setting of temperature set-point and safety device class 3.1. If appropriate, select suitable limit value.
	Controller defective.	Reduce heat load.
Mechanical safety device class 3.2 responds (with option safety device class 3.3).	Safety device defective.	Contact BINDER service.
	Semi-conductor relay defective	
	Limit temperature reached.	Acknowledge the alarm on the controller. Check setting of temperature set-point and safety device class 3.2. If appropriate, select suitable limit value.
Mechanical safety device class 3.2 responds (with option safety device class 3.3).	Controller or safety device defective.	Contact BINDER service.

Fault description	Possible cause	Required measures
Refrigerating performance		
Low or no refrigerating performance.	Ambient temperature > 25 °C / 77 °F (chap.3.4).	Select cooler place of installation.
	Combination of temperature/humidity values not in the optimum range (see temperature humidity diagram, chap. 18).	Select combination of temperature/humidity values in the optimum range (chap. 18).
	Compressor not turned on.	Contact BINDER service.
	Electro-valves defective.	
	No or not enough refrigerant.	
Too much external heat load.	Reduce heat load.	
Humidity		
Humidity fluctuation: Control accuracy of +/- 3 % r.h. is not reached.	Door gasket defective.	Replace door gasket.
	Door opened very frequently.	Open doors less frequently.
Humidity fluctuation, together with temperature fluctuation > 1 °C with a set-point ca. 3 °C above ambient temperature.	Place of installation too hot.	Select cooler place of installation or contact BINDER service.
Low or no dehumidification.	Capillary tube blocked	Contact BINDER service.
	Not enough refrigerant.	
	Humidity control turned off.	Turn on humidity control (chap. 6.3, 8.4).
Icing at the evaporator plates.	Set-point was too long below ambient temperature.	Defrost the chamber (chap. 19).
Condensation at the walls of the inner chamber.	Combination of temperature/humidity values not in the optimum range (see temperature humidity diagram, chap. 18)	Select combination of temperature/humidity values in the optimum range (chap. 18).
	Set-point was too long below ambient temperature, icing in the preheating chamber.	Defrost the chamber (chap. 19)
Low humidity and temperature accuracy	Fan speed has been reduced.	Set fan speed to 100%.
Controller		
No chamber function (dark display).	Display in standby mode.	Press on touchscreen.
	Main power switch turned off.	Turn on the main power switch.
Menu functions not available.	Menu functions not available with current authorization level.	Log in with the required higher authorization or contact BINDER service to obtain an activation code (chap. 14.6).
No access to controller	Password incorrect.	Contact BINDER service.
Chart recorder function: measured-value memory cleared; information lost.	New setting of storage rate or scaling (minimum and/or maximum) (chap. 17.2).	Change the storage rate or scaling ONLY if the previously registered data are no longer required.
Controller does not equilibrate to setpoints entered in Fixed value operation mode	Controller is not in Fixed value operation mode.	Change to Fixed value operation mode.
Controller does not equilibrate to program set-points.	Controller is not in program operation mode, or program delay time is running.	Start the program again. If appropriate, wait for the program delay time.

Fault description	Possible cause	Required measures
Controller (continued)		
Program duration longer than programmed.	Tolerances have been programmed.	For rapid transition phases, do NOT program tolerance limits in order to permit maximum heating, refrigerating, or humidification speed.
Program keeps the last program setpoint constant while in setting "ramp".	Program line with setting "ramp" is incomplete.	When programming with setting "ramp", define the end value of the desired cycle by adding an additional section with a section time of at least one second.
Ramp temperature transitions are only realized as steps.	Setting "step" has been selected.	Select setting "ramp".
Humidity alarm when operating without water connection.	Humidity control turned on.	Turn off humidity control (chap. 6.3).
Acknowledging the alarm does not cancel the alarm state.	Cause of alarm persists.	Remove cause of alarm. If the alarm state continues, contact BINDER service.
Alarm message: ---- or <-<-< or >->->	Sensor rupture between sensor and controller or Pt 100 sensor defective.	Contact BINDER service.
	Short-circuit.	
Miscellaneous		
Fluorescent tube does not illuminate.	Defective fluorescent tube.	Replace all fluorescent tubes of the light cassette.
Impaired valve function of hose burst protection.	Calcification.	Remove calcifications by citric acid or acetic acid solutions (chap. 4.3.4). Have a plumber inspect the valve.

23.6 Sending the chamber back to BINDER GmbH

If you return a BINDER product to us for repair or any other reason, we will only accept the product upon presentation of an **authorization number** (RMA number) that has previously been issued to you. An authorization number will be issued after receiving your complaint either in writing or by telephone **prior** to your sending the BINDER product back to us. The authorization number will be issued following receipt of the information below:

- BINDER product type and serial number
- Date of purchase
- Name and address of the dealer from which you bought the BINDER product
- Exact description of the defect or fault
- Complete address, contact person and availability of that person
- Exact location of the BINDER product in your facility
- A contamination clearance certificate (chap. 28) must be faxed in advance

The authorization number must be applied to the packaging in such a way that it can be easily recognized or be recorded clearly in the delivery documents.



For security reasons we cannot accept a chamber delivery if it does not carry an authorization number.

Return address: BINDER GmbH Gänsäcker 16
 Abteilung Service 78502 Tuttlingen
 Germany

24. Disposal

24.1 Disposal of the transport packing

Packing element	Material	Disposal
Straps to fix packing on pallet	Plastic	Plastic recycling
Wooden transport box (option) with metal screws	Non-wood (compressed match-wood, IPPC standard)	Wood recycling
	Metal	Metal recycling
Pallet with foamed plastic stuffing	Solid wood (IPPC standard)	Wood recycling
	PE foam	Plastic recycling
Transport box with metal clamps	Cardboard	Paper recycling
	Metal	Metal recycling
Top cover	Cardboard	Paper recycling
Edge protection	Styropor® or PE foam	Plastic recycling
Protection of doors and racks	PE foam	Plastic recycling
Bag for operating manual	PE foil	Plastic recycling
Insulating air cushion foil (packing of optional accessories)	PE foil	Plastic recycling

If recycling is not possible, all packing parts can also be disposed of with normal waste.

24.2 Decommissioning

- Turn off the chamber at the main power switch (1) and disconnect it from the power supply (pull the power plug).
- Close the tap used for the water supply.
- Turn off humidity control (chap. 6.3).
- Remove the water installation.
- Temporal decommissioning: See indications for appropriate storage, chap. 3.3.
- Final decommissioning: Dispose of the chamber as described in chap. 24.3 to 24.5.

24.3 Disposal of the chamber in the Federal Republic of Germany

According to Annex I of Directive 2012/19/EU of the European Parliament and of the Council on waste electrical and electronic equipment (WEEE), BINDER devices are classified as “monitoring and control instruments” (category 9) only intended for professional use“. They must not be disposed of at public collecting points.

The chambers bear the symbol for the marking of electrical and electronic equipment manufactured / placed on the market in the EU after 13 August 2005 and be disposed of in separate collection according to Directive 2012/19/EU on waste electrical and electronic equipment (WEEE) and German national law for electrical and electronic equipment (Elektro- und Elektronikgerätegesetz, ElektroG). WEEE marking: crossed-out wheeled bin with solid bar under. A significant part of the materials must be recycled in order to protect the environment.

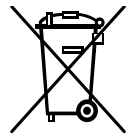



At the end of the device's service life, have the chamber disposed of according to the German national law for electrical and electronic equipment (Elektro- und Elektronikgerätegesetz, ElektroG from 20 October 2015, BGBl. I p. 1739) or contact BINDER service who will organize taking back and disposal of the chamber according to the German national law for electrical and electronic equipment (Elektro- und Elektronikgerätegesetz, ElektroG from 20 October 2015, BGBl. I p. 1739).

	NOTICE
<p>Danger of violation against existing law if not disposed of properly.</p> <ul style="list-style-type: none"> ⊘ Do NOT dispose of BINDER devices at public collecting points. ➤ Have the device disposed of professionally at a recycling company which is certified according to the German national law for electrical and electronic equipment (Elektro- und Elektronikgerätegesetz, ElektroG from 20 October 2015, BGBl. I p. 1739). <li style="text-align: center;"><i>or</i> ➤ Instruct BINDER Service to dispose of the device. The general terms of payment and delivery of BINDER GmbH apply, which were valid at the time of purchasing the chamber. 	

Certified companies disassemble waste (used) BINDER equipment in primary substances for recycling according to Directive 2012/19/EU. The devices must be free from toxic, infectious or radioactive substances in order to eliminate any health hazards to the employees of the recycling companies.

	<p>Prior to handing the chamber over to a recycling company, it is the user's responsibility that it is free from toxic, infectious or radioactive substances.</p> <ul style="list-style-type: none"> • Prior to disposal, clean all introduced or residual toxic substances from the chamber. • Prior to disposal, disinfect the chamber from all sources of infection. Be aware that sources of infection may also be located outside the inner chamber. • If you cannot safely remove all toxic substances and sources of infection from the chamber, dispose of it as special waste according to national law. • Fill out the contamination clearance certificate (chap. 28) and enclose it with the chamber.
---	---

 	 WARNING
<p>Danger of intoxication and infection through contamination of the chamber with toxic, infectious or radioactive substances.</p> <p>Damages to health.</p> <ul style="list-style-type: none"> ⊘ NEVER take a chamber contaminated with toxic substances or sources of infection for recycling according to Directive 2012/19/EU. ➤ Prior to disposal, remove all toxic substances and sources of infection from the chamber. ➤ A chamber from which all toxic substances or sources of infection cannot be safely removed must be considered as “special” waste according to national law. Dispose of it accordingly. 	

The refrigerant used R 134A (1,1,1,2-tetrafluoroethane) is not inflammable at ambient pressure. It must not escape into the environment. In Europe, recovery of the refrigerant R 134A (1300) is mandatory according to regulation No. 842/2006/EC. Ensure the compliance with the applicable legal requirements regarding qualification of staff, disposal, and documentation.

24.4 Disposal of the chamber in the member states of the EU except for the Federal Republic of Germany

According to Annex I of Directive 2012/19/EU of the European Parliament and of the Council on waste electrical and electronic equipment (WEEE), BINDER devices are classified as “monitoring and control instruments” (category 9) only intended for professional use“. They must not be disposed of at public collecting points.

The chambers bear the symbol for the marking of electrical and electronic equipment manufactured / placed on the market in the EC after 13 August 2005 and be disposed of in separate collection according to the Directive 2012/19/EU on waste electrical and electronic equipment (WEEE). WEEE marking: crossed-out wheeled bin with solid bar under.

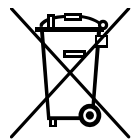





At the end of the device’s service life, notify the distributor who sold you the device, who will take back and dispose of the chamber according to the Directive 2012/19/EU on waste electrical and electronic equipment (WEEE).

	NOTICE
<p>Danger of violation against existing law if not disposed of properly.</p> <ul style="list-style-type: none"> ⊘ Do NOT dispose of BINDER devices at public collecting points. ➤ Have the device disposed of professionally at a recycling company that is certified according to conversion of the Directive 2012/19/EU into national law. <li style="text-align: center;"><i>or</i> ➤ Instruct the distributor who sold you the device to dispose of it. The agreements apply that were agreed with the distributor when purchasing the chamber (e.g. his general terms of payment and delivery). ➤ If your distributor is not able to take back and dispose of the chamber, please contact BINDER service. 	



Certified companies disassemble waste (used) BINDER equipment in primary substances for recycling according to Directive 2012/19/EU. The devices must be free from toxic, infectious or radioactive substances in order to eliminate any health hazards to the employees of the recycling companies.

	<p>Prior to handing the chamber over to a recycling company, it is the user's responsibility that it is free from toxic, infectious or radioactive substances.</p> <ul style="list-style-type: none"> • Prior to disposal, clean all introduced or residual toxic substances from the chamber. • Prior to disposal, disinfect the chamber from all sources of infection. Be aware that sources of infection may also be located outside the inner chamber. • If you cannot safely remove all sources of infection and toxic substances from the chamber, dispose of it as special waste according to national law. • Fill out the contamination clearance certificate (chap. 28) and enclose it with the chamber.
---	---

	<p style="text-align: center;"> WARNING</p>
	<p>Danger of intoxication and infection through contamination of the chamber with toxic, infectious or radioactive substances.</p> <p>Damages to health.</p> <ul style="list-style-type: none"> ⊘ NEVER take a chamber contaminated with toxic substances or sources of infection for recycling according to Directive 2012/19/EU. ➤ Prior to disposal, remove all toxic substances and sources of infection from the chamber. ➤ A chamber from which all toxic substances or sources of infection cannot be safely removed must be considered as "special" waste according to national law. Dispose of it accordingly.
	

The refrigerant used R 134A (1,1,1,2-tetrafluoroethane) is not inflammable at ambient pressure. It must not escape into the environment. In Europe, recovery of the refrigerant R 134A (1300) is mandatory according to regulation No. 842/2006/EC. Ensure the compliance with the applicable legal requirements regarding qualification of staff, disposal, and documentation.

24.5 Disposal of the chamber in non-member states of the EU

	<p style="text-align: center;">NOTICE</p>
	<p>Danger of violation against existing law if not disposed of properly.</p> <p>Alteration of the environment.</p> <ul style="list-style-type: none"> ➤ For final decommissioning and disposal of the chamber, please contact BINDER service. ➤ Follow the statutory regulations for appropriate, environmentally friendly disposal.

The main board of the chamber includes a lithium cell. Please dispose of it according to national regulations.

The refrigerant used R 134A (1,1,1,2-tetrafluoroethane) is not inflammable at ambient pressure. It must not escape into the environment. In Europe, recovery of the refrigerant R 134A (1300) is mandatory according to regulation No. 842/2006/EC. Ensure the compliance with the applicable legal requirements regarding qualification of staff, disposal, and documentation.

25. Technical description

25.1 Factory calibration and adjustment

The chambers were calibrated and adjusted in the factory. Calibration and adjustment were performed using standardized test instructions, according to the QM DIN EN ISO 9001 system applied by BINDER (certified since December 1996 by TÜV CERT). All test equipment used is subject to the administration of measurement and test equipment that is also a constituent part of the BINDER QM DIN EN ISO 9001 systems. They are controlled and calibrated to a DKD-Standard at regular intervals.

	Repeated calibrations are recommended in periods of 12 months.
---	--

25.2 Over current protection

The chambers are equipped with an internal fuse not accessible from outside. If this fuse is blown, please contact an electronic engineer or BINDER service.

25.3 Definition of usable volume

The usable volume illustrated below is calculated as follows:

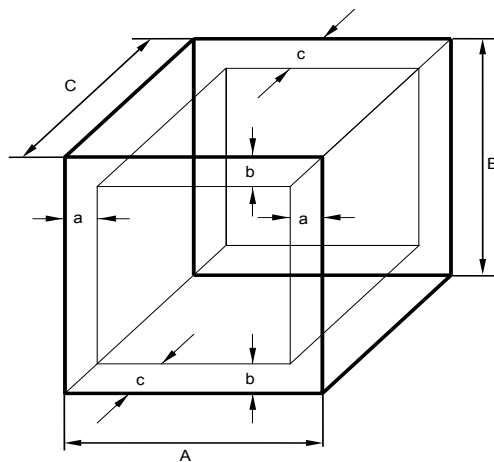

A, B, C = internal dimensions (W, H, D)

a, b, c = distance to wall

$$a = 0.1 * A$$

$$b = 0.1 * B$$

$$c = 0.1 * C$$

$$V_{USE} = (A - 2 * a) * (B - 2 * b) * (C - 2 * c)$$

Figure 42: Determination of the useable volume

The technical data refers to the defined usable volume.

	<p>Do NOT place samples outside this usable volume.</p> <p>Do NOT load this volume by more than half to enable sufficient airflow inside the chamber.</p> <p>Do NOT divide the usable volume into separate parts with large area samples.</p> <p>Do NOT place samples too close to each other in order to permit circulation between them and thus obtain a homogenous distribution of temperature and humidity.</p>
---	--

25.4 Technical Data



Chamber size		240	720
Exterior dimensions			
Width, net	mm / inch	925 / 36.42	1250 / 49.21
Height, gross (incl. castors)	mm / inch	1460 / 57.48	1925 / 75.79
Depth, net	mm / inch	800 / 31.50	890 / 35.04
Depth, gross (including door handle, I-triangle, connection and 30 mm for cable)	mm / inch	880 / 34.65	970 / 38.19
Wall clearance rear (minimum) (spacers)	mm / inch	100 / 3.94	100 / 3.94
Wall clearance side (minimum)	mm / inch	160 / 6.29	160 / 6.29
Doors			
Quantity of doors		1	2
Quantity of inner glass doors		1	2
Interior dimensions			
Width	mm / inch	650 / 25.60	973 / 38.31
Height	mm / inch	785 / 30.91	1250 / 49.21
Depth	mm / inch	485 / 19.09	576 / 22.68
Interior volume	l / cu.ft.	247 / 8.7	700 / 24.7
Steam space volume	l / cu.ft.	348 / 12.3	918 / 32.4
Racks			
Quantity of racks (regular)		2	3
Quantity of racks (max.)		7	12
Quantity of light cassettes		2	3
Maximum load per rack	kg / lbs.	30 / 66	45 / 99
Maximum permitted total load	kg / lbs.	100 / 220	150 / 331
Weight			
Weight (empty)	kg / lbs.	214 / 472	374 / 825
Temperature data (without humidity)			
Temperature range without light cassettes	°C / °F	0 to +70 / 32 to 158	
Temperature range with light cassettes, with illumination	°C / °F	+10 to +60 / 50 to 140	
Max. heat compensation at 40 °C / 104 °F, with illumination	W	400	1000
Climatic data (with humidity) for KBF P / KBF P-UL, KBF LQC / KBF LQC-UL			
Temperature range without light cassettes	°C / °F	+10 to +70 / 50 to 158	+10 to +70 / 50 to 158
Temperature range with light cassettes, with illumination	°C / °F	+10 to +60 / 50 to 140	+20 to +60 / 68 to 140
Temperature fluctuation with illumination	at 25 °C / 77 °F and 60% r.h.	± K	0.2
	at 40 °C / 104 °F and 75% r.h.	± K	0.2
Temperature uniformity (variation) with illumination	at 25 °C / 77 °F and 60% r.h.	± K	0.6
	at 40 °C / 104 °F and 75% r.h.	± K	0.6
Humidity range without light cassettes	% r.h.	10 to 80	10 to 80
Humidity range with light cassettes, with illumination	% r.h.	10 to 75	10 to 75
Humidity fluctuation with illumination	at 25 °C / 77 °F and 60% r.h.	+/- % r.h.	≤ 1.5
	at 40 °C / 104 °F and 75% r.h.	+/- % r.h.	≤ 2.0
Recovery time after doors were open for 30 sec.	at 25 °C / 77 °F and 60% r.h.	minutes	4
	at 40 °C / 104 °F and 75% r.h.	minutes	6

Chamber size		240	720	
Climatic data (with humidity) for KBWF				
Temperature range without light cassettes	°C / °F	+10 to +70 / 50 to 158	+10 to +70 / 50 to 158	
Temperature range with light cassettes, with illumination	°C / °F	+10 to +60 / 50 to 140	+20 to +60 / 68 to 140	
Temperature fluctuation with illumination	± K	0.1 to 1.0	0.1 to 0.5	
Temperature uniformity (variation) with illumination	± K	0.5 to 1.0	1.0 to 1.5	
Humidity range without light cassettes	% r.h.	10 to 80	10 to 80	
Humidity range with light cassettes, with illumination	% r.h.	10 to 75	10 to 75	
Humidity fluctuation with illumination	+/- % r.h.	≤ 2	≤ 2,5	
Illumination data per light cassette				
ICH compliant illumination for photo stability testing	Lux	7500	9000	
	UVA W/m ²	1.1	1.5	
Daylight fluorescent tubes	Lux	9000	13000	
	W/m ²	24	38	
Fluora® growth lamps	Lux	7500	10500	
	W/m ²	23	36	
Arabidopsis lamps	Lux	11000	14000	
	W/m ²	32	43	
Electrical data (model versions KBFP-230V, KBFLQC-230V, KBWF-230V)				
System of protection acc. to EN 60529	IP	20	20	
Nominal voltage (+/-10%) at 50 Hz power frequency	V	200-230	200-230	
Current type		1N~	1N~	
Power plug		shock proof plug		
Nominal power	kW	2.40	3.50	
Installation category acc. to IEC 61010-1		II	II	
Pollution degree acc. to IEC 61010-1		2	2	
Over-current release category B, 2 poles	Amp	16	16	
Different electrical data for UL chambers constructed for the USA and Canada (model versions KBFP240UL-240V, KBFP720UL-240V, KBFLQC240UL-240V, KBFLQC720UL-240V)				
Nominal voltage (+/-10%)	at 50 Hz power frequency	V	200-240	200-240
	at 60 Hz power frequency	V	200-240	200-240
Current type		2~	2~	
Power plug	NEMA	6-20P	6-20P	
Environment-specific data				
Noise level (mean value)	dB (A)	53	59	
Energy consumption at 40 °C / 104 °F and 75 % r.h.	Wh/h	760	1850	
Filling weight of refrigerant R 134A (GWP 1300)	kg	0.575	0.800	

Illumination data: Average value, measured at +22 °C +/- 3 °C / 71.6 °F +/- 5.4 °F with a spherical sensor (+/-10%) by 12 cm / 4.7 in below the light cassette. The values given in W/m² refer to global radiation.

All technical data is specified for unloaded chambers with standard equipment at an ambient temperature of +22 °C +/- 3 °C / 71.6 °F +/- 5.4 °F and a power supply voltage fluctuation of +/-10%. Technical data is determined in accordance to BINDER factory standard Part 2:2015 and DIN 12880:2007.

All indications are average values, typical for chambers produced in series. We reserve the right to change technical specifications at any time.

	If the chamber is fully loaded, the specified heating up and cooling down times may vary according to the load.
	Bringing a source of humidity into the inner chamber will affect the minimum humidity specification and may affect the humidity accuracy.

25.5 Equipment and options (extract)

	To operate the chamber, use only original BINDER accessories or accessories / components from third-party suppliers authorized by BINDER. The user is responsible for any risk arising from using unauthorized accessories.
---	---

Regular equipment
Microprocessor display program controller with 2-channel technology for temperature and humidity
<i>KBF LQC / KBF LQC-UL</i> : "Light Quantum Control" function
Ethernet interface for computer communication
Temperature safety device class 3.1 acc. to DIN 12880:2007
Inner glass door with gasket
DCT™ refrigerating system with refrigerant R134a
Microprocessor controlled humidifying and dehumidifying system *) (humidity range, see diagram)
Four castors (2 lockable)
2 racks, stainless steel
Access port 30 mm with silicone plug
<i>KBF P / KBF P-UL, KBF LQC / KBF LQC-UL</i> : ICH compliant illumination for photo stability testing: ICH light (cool white + BINDER Q1B Synergy Light), 2 (size 240) resp. 3 (size 720) light cassettes
<i>KBWF</i> : Illumination system: Daylight illumination tubes light color 865, 2 (size 240) resp. 3 (size 720) light cassettes
<i>KBF LQC / KBF LQC-UL</i> : Spherical light sensors to measure the illumination from 0 kLUX up to 50 kLUX, and the UV intensity from 0 W/m ² up to 50 W/m ² UVA

*) A water supply (1 to 10 bar) is necessary for the installation of the humidifying and de-humidifying system (chap. 4.3). If no suitable house water connection is available, you can manually supply water by filling a freshwater can (option, chap. 21.9). Furthermore, a water drain in a max. distance of 3 meters / 9.8 ft. and a max. height of 1 meter / 3.3 ft. is required (chap. 4.2).

Options / accessories
Additional rack, stainless steel
Perforated shelf, stainless steel
Reinforced rack with rack lockings
Securing elements for additional fastening of racks (4 pieces)
Light cassette
<i>KBF P / KBF P-UL, KBF LQC / KBF LQC-UL</i> : Set of fluorescent tubes ICH light (cool white + BINDER Q1B Synergy Light) for 1 light cassette
<i>KBWF</i> : Set of fluorescent tubes daylight (light color 865), for 1 light cassette
<i>KBWF</i> : Set of fluorescent tubes Fluora® (light color 77) replacing the daylight fluorescent tubes, for 1 light cassette
<i>KBWF</i> : Set of fluorescent tubes for Arabidopsis (light color 841) replacing the daylight fluorescent tubes, for 1 light cassette
Temperature safety device class 3.3 acc. to DIN 12880:2007
Zero-voltage relay alarm outputs for temperature and humidity with DIN plug 6-poles
Lockable door
Access ports 30 mm or 50 mm or 100 mm with silicone plug
Analog outputs 4-20 mA for temperature and humidity with 6 pole DIN socket, DIN plug included
Flexible Pt 100 temperature sensor, output to DIN socket (BINDER INDIVIDUAL customized solutions)
Object temperature display with flexible Pt 100 temperature sensor
Communication interface RS485
BINDER Data Logger kit for temperature / humidity: TH 70 (chamber values) or TH 70/70 (chamber and ambient values)

Options / accessories (continued)
External freshwater and wastewater cans (20 liters / 0.71 cu.ft. each)
BINDER Pure Aqua Service
Exchange cartridge for BINDER Pure Aqua Service
Safety kit for water connection with hose burst protection device and reflux protection device, pre-mounted assembly (BINDER INDIVIDUAL customized solutions)
<i>KBF P 240 / KBF LQC 240</i> : Voltage changer for operation at 115 Volt
Water protected internal socket 230 V AC
Calibration of temperature and humidity including certificate
Spatial temperature and humidity measurement including certificate
Spatial temperature and humidity measurement acc. to DIN 12880:2007 including certificate
<i>KBF P / KBF P-UL, KBF LQC / KBF LQC-UL</i> : Illumination measurement certificate: Radiometrical measurement in visible and UVA spectral range with documentation of intensity distribution and of qualitative spectral distribution
<i>KBWF</i> : Illumination measurement certificate: Radiometrical measurement with documentation of intensity distribution and of qualitative spectral distribution
Qualification folder

25.6 Accessories and spare parts (extract)

	BINDER GmbH is responsible for the safety features of the chamber only, provided skilled electricians or qualified personnel authorized by BINDER perform all maintenance and repair, and if components relating to chamber safety are replaced in the event of failure with original spare parts. The user is responsible for any risks arising from using unauthorized accessories/components.
--	--

Chamber size	240	720
Description	Art. no.	
Rack, stainless steel	6004-0101	6004-0106
Perforated rack, stainless steel	6004-0040	8009-0486
Stable rack with additional fixing for shaker operation	8012-0639	8012-0673
Reinforced rack with rack lockings	8012-0638	8012-0674
Rack lockings (4 pieces)	8012-0620	8012-0620
Door gasket for glass door	6005-0149	6005-0198
Door gasket silicone (kettle)	6005-0147	6005-0196
Door gasket silicone (outer door)	6005-0161	6005-0197
Intermediate door gasket, silicone	---	6005-0192
<i>KBF P / KBF P-UL, KBF LQC / KBF LQC-UL</i> : Light cassette	8009-0610	8009-0495
<i>KBWF</i> : Light cassette	8009-0611	8009-0523
<i>KBF P / KBF P-UL, KBF LQC / KBF LQC-UL</i> : Set of fluorescent tubes ICH light (cool white + BINDER Q1B Synergy Light) for 1 light cassette	8012-0657	8012-0699
<i>KBWF</i> : Set of fluorescent tubes daylight (light color 865), for 1 light cassette	8500-0024	8500-0025
<i>KBWF</i> : Set of fluorescent tubes Fluora® (light color 77) replacing the daylight fluorescent tubes, for 1 light cassette	8500-0022	8500-0026
<i>KBWF</i> : Set of fluorescent tubes for Arabidopsis (light color 841) replacing the daylight fluorescent tubes, for 1 light cassette	8500-0023	8500-0027
<i>KBF P / KBF P-UL, KBF LQC / KBF LQC-UL</i> : Replacement glass for light cassette	8010-0081	8010-0087
<i>KBWF</i> : Replacement glass for light cassette	8010-0085	8010-0087

Description	Art. no.
Plug for silicon access port d30	6016-0035
External freshwater and wastewater cans (20 liters / 0.71 cu.ft. each)	8012-0643
BINDER Pure Aqua Service	8012-0759
Exchange cartridge for BINDER Pure Aqua Service	6011-0165
Safety kit for water connection with hose burst protection device and reflux protection device	BINDER Individual Customized Solutions
<i>KBF P 240 / KBF LQC 240</i> : Voltage changer for operation at 115 Volt	8009-0821
Light sensor UVA	5002-0063
Light sensor V-λ (LUX)	5002-0062
Data Logger Kit TH 70	8012-0716
Data Logger Kit TH 70/70	8012-0717
Neutral cleaning agent, 1 kg	1002-0016

For information on components not listed here, please contact BINDER Service.

Validation service	Art. no.
Qualification folder IQ-OQ (printed version)	7007-0003
Qualification folder IQ-OQ (digital version)	7057-0003
Qualification folder IQ-OQ-PQ (printed version)	7007-0007
Qualification folder IQ-OQ-PQ (digital version)	7057-0007
Execution of IQ-OQ including light measurement	DL430400
Execution of IQ-OQ-PQ including light measurement	DL440500

Calibration service	Art. no.
Calibration of temperature and humidity including certificate (1 measuring point)	DL300301
Spatial temperature and humidity measurement including certificate (9 measuring points temperature, 1 measuring point humidity)	DL300309
Spatial temperature and humidity measurement including certificate (18 measuring points temperature, 1 measuring point humidity)	DL300318
Spatial temperature and humidity measurement including certificate (27 measuring points temperature, 1 measuring point humidity)	DL300327
<i>KBF P / KBF P-UL, KBF LQC / KBF LQC-UL</i> : Illumination measurement including certificate: 25 measuring points, intensity measurement in visible and UVA spectral range with documentation of intensity distribution and of qualitative spectral distribution	DL300525
<i>KBWF</i> : Illumination measurement including certificate: 25 measuring points, intensity measurement with documentation of intensity distribution and of qualitative spectral distribution	DL310000

25.7 Dimensions size 240

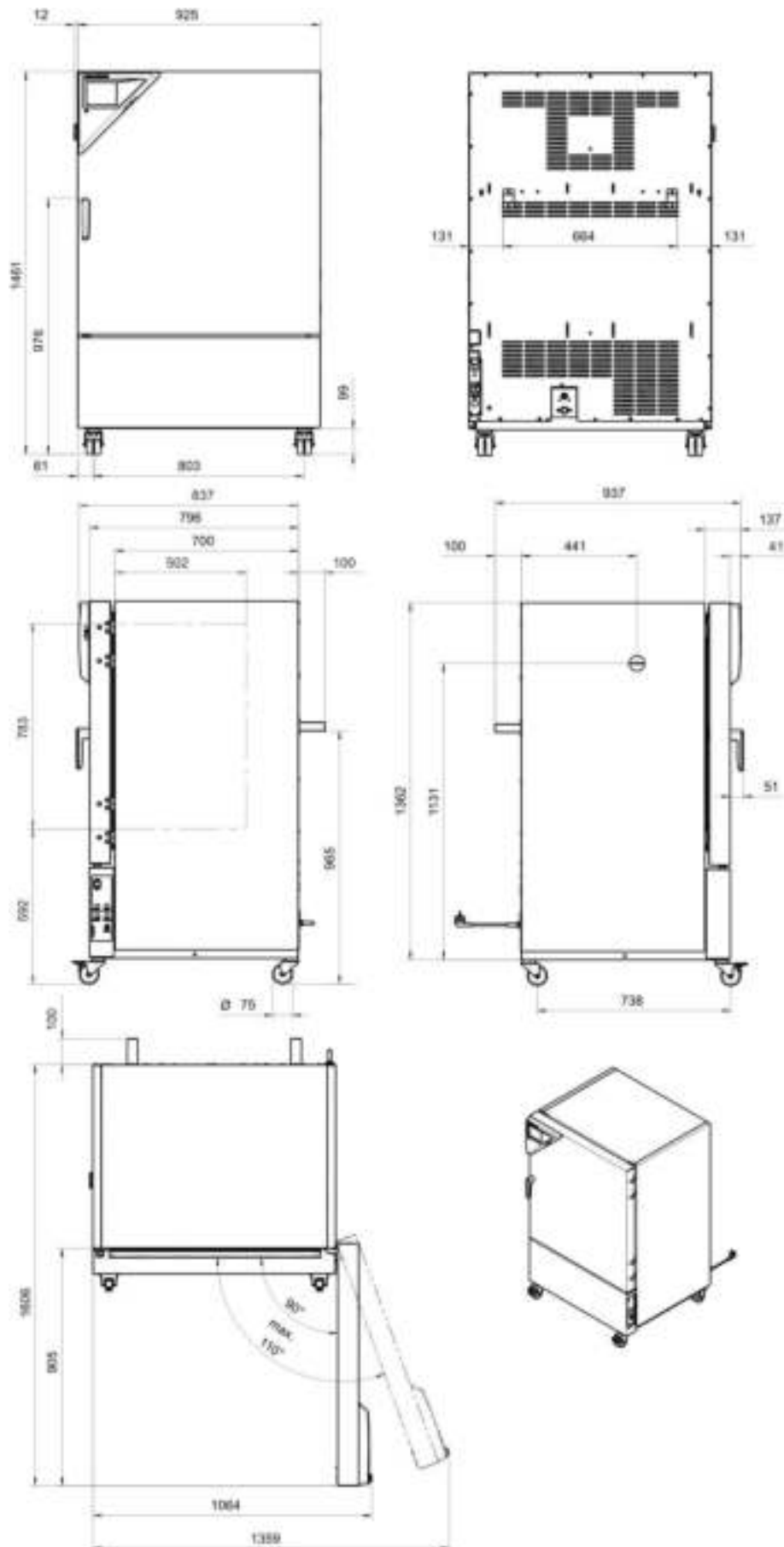

25.8 Dimensions size 720

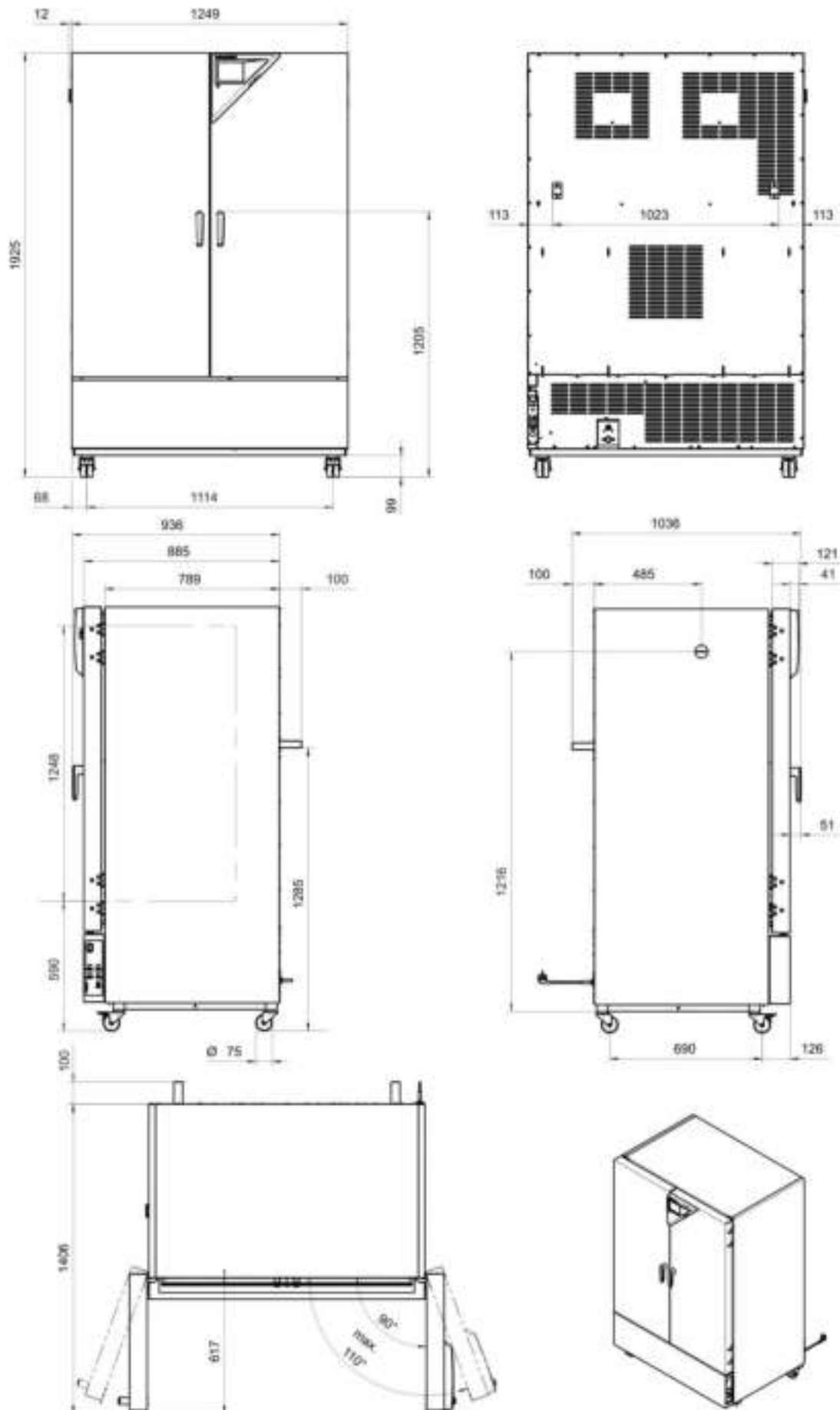

26. Certificates and declarations of conformity

26.1 EU Declaration of Conformity for KBF P



Best conditions for your success

EU-Konformitätserklärung / EU Declaration of Conformity / Déclaration de conformité UE / Declaración de conformidad UE / Dichiarazione di conformità UE / Декларация соответствия EU

Hersteller / Manufacturer / Fabricant / Fabricante / Fabbricante / Производитель	BINDER GmbH
Anschrift / Address / Adresse / Dirección / Indirizzo / Адрес	Im Mittleren Ösch 5, 78532 Tuttlingen, Germany
Produkt / Product / Produit / Producto / Prodotto / Продукт	Konstantklimaschränke Constant climate chambers Enceintes climatiques pour des conditions constantes Cámaras de clima constante Camere per condizioni climatiche costanti Климатическая камера постоянных условий
Typenbezeichnung / Type / Type / Tipo / Tipo / Тип	KBF P 240, KBF P 720

Die oben beschriebenen Maschinen sind konform mit folgenden EG/EU-Richtlinien (gemäß Veröffentlichung im Amtsblatt der europäischen Kommission):
The machines described above are in conformity with the following EC/EU Directives (as published in the Official Journal of the European Union):
Les machines décrites ci-dessus sont conformes aux directives CE/UE suivantes (selon leur publication dans le Journal officiel de l'Union européenne):
La máquina descrita arriba cumple con las siguientes directivas de la CE/UE (publicados en el Diario oficial de la Unión Europea):
Le macchine sopra descritte sono conforme alle seguenti direttive CE/UE (secondo la pubblicazione nella Gazzetta ufficiale della Commissione europea):
Машина, указанная выше, полностью соответствует следующим регламентам ЕС/ЕУ (опубликованным в Официальном журнале Европейского Содружества):

- **2006/42/EC**
Maschinenrichtlinie 2006/42/EG / Machinery directive 2006/42/EC / Directive Machines 2006/42/EC / Directiva 2006/42/CE (Máquinas) / Direttiva macchine 2006/42/CE / Директива о машинах 2006/42/EC
- **2014/30/EU**
EMV-Richtlinie 2014/30/EU / EMC Directive 2014/30/EU / Directive CEM 2014/30/UE / Directiva CEM 2014/30/UE / Direttiva EMC 2014/30/UE / Директива ЭМС 2014/30/EU
- **2011/65/EU**
RoHS-Richtlinie 2011/65/EU / RoHS Directive 2011/65/EU / Directive RoHS 2011/65/UE / Directiva RoHS 2011/65/UE / Direttiva RoHS 2011/65/UE / Директива RoHS 2011/65/EU

1 / 3

BINDER GmbH | Postfach 112 | D-78532 Tuttlingen | Address: BINDER GmbH | Im Mittleren Ösch 5 | 78532 Tuttlingen | Germany
Contact: Phone +49 (0) 71 82 / 20 05 - 0 | Fax +49 (0) 71 82 / 20 05 - 105 | info@binder-world.com | www.binder-world.com
Managing Director: Dipl.-Ing. Peter M. Binder | District Court Stuttgart | HRB 721152 | Company head office: Tuttlingen | Germany
Payment Details: Hauptkassenamt Tuttlingen | Account no.: 2255 | BIKF 241 602 70 | BIC Code: BFSW333 | SWIFT Code: BFSW3333 | IBAN: DE 2512 0510 0000 0000 0000 0000
Bank for Social Security: 2512 0510 0000 0000 0000 0000 | BIC Code: BFSW3333 | SWIFT Code: BFSW3333
Bank for Social Security: 2512 0510 0000 0000 0000 0000 | BIC Code: BFSW3333 | SWIFT Code: BFSW3333
Recycling of old equipment according to WEEE Reg. no. DE 67004603

Die oben beschriebenen Maschinen entsprechen aufgrund ihrer Konzipierung und Bauart sowie in der von uns in Verkehr gebrachten Ausführung den einschlägigen grundlegenden Sicherheits- und Gesundheitsanforderungen der genannten EG/EU-Richtlinien.

The machines described above are conform to the mentioned EC/EU directives in regard to the relevant safety and health demands due to their conception and style of construction as well as to the version put onto market by us.

Les machines décrites ci-dessus correspondent aux demandes de sécurité et de santé des directives citées de la CE/UE due à leur conception et construction et dans la réalisation mise sur le marché par nous.

Las máquinas descritas arriba se corresponden con los requisitos básicos pertinentes de seguridad y salud de las citadas directivas de la CE/UE debido a su concepción y fabricación, así como a la realización llevada a cabo por nosotros.

Le macchine sopra descritte sono conforme ai requisiti essenziali di sanità e sicurezza pertinenti delle summenzionate direttive CE/UE in termini di progettazione, tipo di costruzione ed esecuzione messa da noi in circolazione.

Машины описано выше, соответствует указанным директивам ЕС/ЕУ в отношении требований соответствующей безопасности и здоровья по концепции и конструкции так же как и версия, применяемая нами на рынке.

Die oben beschriebenen Maschinen tragen entsprechend die Kennzeichnung CE.

The machines described above, corresponding to this, bear the CE-mark.

Les machines décrits ci-dessus, en correspondance, portent l'indication CE.

Las maquinas descritas arriba, en conformidad, llevan la indicación CE.

Le macchine sopra descritte sono contrassegnate dal marchio CE.

Машины описано выше, в соответствии с икопложенным выше маркированы знаком CE.

Die oben beschriebenen Maschinen sind konform mit folgenden harmonisierten Normen:

The machines described above are in conformity with the following harmonized standards:

Les machines décrits ci-dessus sont conformes aux normes harmonisées suivantes:

Las maquinas descritas arriba cumplen con las siguientes normas:

Le macchine sopra descritte sono conforme alle seguenti normative armonizzate:

Машины описано выше, полностью соответствуют следующим стандартам:

Sicherheit / Safety / Sécurité / Seguridad / Sicurezza / Нормативы по безопасности
<ul style="list-style-type: none"> • EN ISO 12100:2010 + Corr. 1:2011 • EN ISO 13732-1:2008 • EN 60204-1:2006 + A1:2009 + Corr. :2010
EMV / EMC / CEM / CEM / EMC / ЗМС
<ul style="list-style-type: none"> • EN 61326-1:2013
RoHS
<ul style="list-style-type: none"> • EN 50581:2012

78532 Tuttlingen, 03.07.2017
BINDER GmbH



P. M. Binder

Geschäftsführender Gesellschafter
Managing Director
Directeur général
Director general
Direttore Generale
Директор



J. Bollaender

Leiter F & E und Dokumentationsbeauftragter
Director R & D and documentation representative
Chef de service R&D et autorisé de documentation
Responsabile I & D y representante de documentación
Direttore R & D e responsabile della documentazione
Глава департамента R&D представитель документации

3/3

BINDER GmbH Postfach 102 D-78532 Tuttlingen Address: BINDER GmbH | Im Hiltener Dack 2 | 78532 Tuttlingen | Germany
Contact: Phone: +49 (0) 74 62 7 20 00 - 0 | Fax: +49 (0) 74 62 7 20 00 - 100 | info@binder-werk.com | www.binder-werk.com
Managing Director: Dipl.-Ing. Peter M. Binder | Dattstr. 22/24 | 78532 Tuttlingen | Germany
Payment Details: Kfz Leasing: Kfz Leasing Tuttingen | Account no.: 2098 | BIK: 251203 | IBAN: 440 503 70 0 | BIC: BFSW3333 | SWIFT Code: BFSW3333
B-ACCOUNT No.: 2022 811 00 | IBAN Code: 087460300010 0001 001100 | SWIFT Code: SOLA DE 3111UT
Deutsche Bank Tuttingen | Account no.: 2 130 700 | BIK: 251203 | IBAN: 440 503 70 0 | BIC: BFSW3333 | SWIFT Code: BFSW3333
Recycling of old equipment according to WEEE-Reg. no. DE 37004985

26.2 EU Declaration of Conformity for KBF LQC



Best conditions for your success



EU-Konformitätserklärung / EU Declaration of Conformity / Déclaration de conformité UE / Declaración de conformidad UE / Dichiarazione di conformità UE / Декларация соответствия EU

Hersteller / Manufacturer / Fabricant / Fabricante / Fabbricante / Производитель	BINDER GmbH
Anschrift / Address / Adresse / Dirección / Indirizzo / Адрес	Im Mittleren Ösch 5, 78532 Tuttlingen, Germany
Produkt / Product / Produit / Producto / Prodotto / Продукт	Konstantklimaschränke Constant climate chambers Enceintes climatiques pour des conditions constantes Cámaras de clima constante Cameri per condizioni climatiche costanti Климатическая камера постоянных условий
Typenbezeichnung / Type / Type / Tipo / Tipo / Тип	KBF LQC 240, KBF LQC 720

Die oben beschriebenen Maschinen sind konform mit folgenden EG/EU-Richtlinien (gemäß Veröffentlichung im Amtsblatt der europäischen Kommission):

The machines described above are in conformity with the following EC/EU Directives (as published in the Official Journal of the European Union):

Les machines décrites ci-dessus sont conformes aux directives CE/UE suivantes (selon leur publication dans le Journal officiel de l'Union européenne):

La máquina descrita arriba cumple con las siguientes directivas de la CE/UE (publicados en el Diario oficial de la Unión Europea):

Le macchine sopra descritte sono conforme alle seguenti direttive CE/UE (secondo la pubblicazione nella Gazzetta ufficiale della Commissione europea):

Машина, указанная выше, полностью соответствует следующим регламентам ЕС/ЕУ (опубликованным в Официальном журнале Европейского Содружества):

- **2006/42/EC**
Maschinenrichtlinie 2006/42/EG / Machinery directive 2006/42/EC / Directive Machines 2006/42/EC / Directiva 2006/42/CE (Máquinas) / Direttiva macchine 2006/42/CE / Директива о машинах 2006/42/EC
- **2014/30/EU**
EMV-Richtlinie 2014/30/EU / EMC Directive 2014/30/EU / Directive CEM 2014/30/UE / Directiva CEM 2014/30/UE / Direttiva EMC 2014/30/UE / Директива ЭМС 2014/30/EU
- **2011/65/EU**
RoHS-Richtlinie 2011/65/EU / RoHS Directive 2011/65/EU / Directive RoHS 2011/65/UE / Directiva RoHS 2011/65/UE / Direttiva RoHS 2011/65/UE / Директива RoHS 2011/65/EU

1 / 3

BINDER GmbH Postfach 102, D-78532 Tuttlingen, **Address BINDER GmbH** Im Mittleren Ösch 5, 78532 Tuttlingen, Germany
 Contact: Phone: +49 (0) 71 42 / 20 10 - 0 | Fax: +49 (0) 71 42 / 20 10 - 100 | info@binder-werk.com | www.binder-werk.com
Managing Director: Gert-Ing. Peter M. Binder | **Central office Stuttgart, HRB 727150** | **Company head office: Tuttlingen, Germany**
Payment Details: Kirschenallee Tuttlingen, Account no.: 2286 5461 543 70 | IBAN Code: DE2600 000700 00000286 | SWIFT Code: SOLA DE 311UT
 Z-Account no.: 2252 511 55 | IBAN Code: DE7443 02070 0000 001155 | SWIFT Code: SOLA DE 311UT
 Deutsche Bank Tuttlingen, Account no.: 2 708 706 | IBAN Code: DE2600 70070 0213070800 | SWIFT Code: DEUT DE 33030
 Recycling of old equipment according to WEEE-Reg.-no. DE 27036662



Die oben beschriebenen Maschinen entsprechen aufgrund ihrer Konzipierung und Bauart sowie in der von uns in Verkehr gebrachten Ausführung den einschlägigen grundlegenden Sicherheits- und Gesundheitsanforderungen der genannten EG/EU-Richtlinien.

The machines described above are conform to the mentioned EC/EU directives in regard to the relevant safety and health demands due to their conception and style of construction as well as to the version put onto market by us.

Les machines décrites ci-dessus correspondent aux demandes de sécurité et de santé des directives citées de la CE/UE due à leur conception et construction et dans la réalisation mise sur le marché par nous.

Las máquinas descritas arriba se corresponden con los requisitos básicos pertinentes de seguridad y salud de las citadas directivas de la CE/UE debido a su concepción y fabricación, así como a la realización llevada a cabo por nosotros.

Le macchine sopra descritte sono conforme ai requisiti essenziali di sanità e sicurezza pertinenti delle summenzionate direttive CE/UE in termini di progettazione, tipo di costruzione ed esecuzione messa da noi in circolazione.

Машины описано выше, соответствует указанным директивам EG/EU в отношении требований соответствующей безопасности и здоровья по концепции и конструкции так же как и версия, применяемая нами на рынке.

Die oben beschriebenen Maschinen tragen entsprechend die Kennzeichnung CE.

The machines described above, corresponding to this, bear the CE-mark.

Les machines décrits ci-dessus, en correspondance, portent l'indication CE.

Las máquinas descritas arriba, en conformidad, llevan la indicación CE.

Le macchine sopra descritte sono contrassegnate dal marchio CE.

Машины описано выше, в соответствии с изложенным выше маркированы знаком CE.

Die oben beschriebenen Maschinen sind konform mit folgenden harmonisierten Normen:

The machines described above are in conformity with the following harmonized standards:

Les machines décrits ci-dessus sont conformes aux normes harmonisées suivantes:

Las máquinas descritas arriba cumplen con las siguientes normas:

Le macchine sopra descritte sono conforme alle seguenti normative armonizzate:

Машины описано выше, полностью соответствуют следующим стандартам:

Sicherheit / Safety / Sécurité / Seguridad / Sicurezza / Нормативы по безопасности
<ul style="list-style-type: none"> • EN ISO 12100:2010 + Corr. 1:2011 • EN ISO 13732-1:2008 • EN 60204-1:2006 + A1:2009 + Corr. :2010
EMV / EMC / CEM / CEM / EMC / ЗМС
<ul style="list-style-type: none"> • EN 61326-1:2013
RoHS
<ul style="list-style-type: none"> • EN 50581:2012

2 / 3

BINDER GmbH Postfach 102 D-72022 Tuttlingen Address: BINDER GmbH, Im Millen Och 2, 72022 Tuttlingen, Germany
 Contact: Phone: +49 (0) 74 62 / (0) 38 - 0 | Fax: +49 (0) 74 62 / 32 02 - 100 | info@binder-werk.com | www.binder-werk.com
 Managing Director: Dipl.-Ing. Peter M. Binder | Daimlerstr. Stuttgart, HRB 727192 | Company Head Office: Tuttlingen, Germany
 Payment Details: Kreditanstalt für Wirtschaftsprüfung, Account No.: 2389 | BIC: 2489 3300 70 | IBAN Code: DE33 610 30000 00000 0000 | SWIFT Code: SOLA DE 3111 UT
 Deutsche Bank Stuttgart, Account No.: 2 136 709 | BIC: 2512 3300 75 | IBAN Code: DE33 610 30000 00000 0000 | SWIFT Code: SOLA DE 3111 UT
 Recycling of old equipment according to WEEE Reg. No. DE 37004989

78532 Tuttlingen, 03.07.2017
BINDER GmbH



P. M. Binder

Geschäftsführender Gesellschafter
Managing Director
Directeur général
Director general
Direttore Generale
Директор



J. Bollaender

Leiter F & E und Dokumentationsbeauftragter
Director R & D and documentation representative
Chef de service R&D et autorisé de documentation
Responsabile I & D y representante de documentación
Direttore R & D e responsabile della documentazione
Глава департамента R&D представлять документацию

3 / 3

BINDER GmbH Postbox 102 D-78532 Tuttlingen Address: BINDER Green, 1A Mittelweg Ost 2, 78532 Tuttlingen, Germany
Contact: Phone: +49 (0) 74 62 7 20 00 - 0 | Fax: +49 (0) 74 62 7 20 05 - 100 | info@binder-world.com | www.binder-world.com
Managing Director: Dipl.-Ing. Peter M. Binder | Credit court Stuttgart HRB 027145 | Company head office: Tuttlingen, Germany
Payment Details: Kfz-Kreditgeber Tuttlingen Account no.: 0206 | BIK: 840 800 70 | IBAN: Code: 0325043 00000206 | SWIFT Code: SOLA DE 311UJ
S-Account no.: 2002 011 88 | IBAN: Code: 027464200010 0001 001 000 | SWIFT Code: SOLA DE 311UJ
Deutsche Bank Tuttlingen Account no.: 2 136 708 | BIK: 855 700 70 | IBAN: Code: 0650003 10019 0213010000 | SWIFT Code: DBLT DE 3303
Recycling of old equipment according to WEEE-Reg.-no. DE 37004985

26.3 EU Declaration of Conformity for KBWF



Best conditions for your success



EU-Konformitätserklärung / EU Declaration of Conformity / Déclaration de conformité UE / Declaración de conformidad UE / Dichiarazione di conformità UE / Декларация соответствия EU

Hersteller / Manufacturer / Fabricant / Fabricante / Fabbricante / Производитель	BINDER GmbH
Anschrift / Address / Adresse / Dirección / Indirizzo / Адрес	Im Mittleren Ösch 5, 78532 Tuttlingen, Germany
Produkt / Product / Produit / Producto / Prodotto / Продукт	Wachstumsschränke mit Licht und Feuchte Growth chambers with light and humidity Appareils de croissance avec illumination et humidité Cámaras de crecimiento con iluminación y humedad Camere di crescita con luce e umidità Камеры роста с освещением и влажностью
Typenbezeichnung / Type / Type / Tipo / Tipo / Тип	KBWF 240, KBWF 720

Die oben beschriebenen Maschinen sind konform mit folgenden EG/EU-Richtlinien (gemäß Veröffentlichung im Amtsblatt der europäischen Kommission):

The machines described above are in conformity with the following EC/EU Directives (as published in the Official Journal of the European Union):

Les machines décrites ci-dessus sont conformes aux directives CE/UE suivantes (selon leur publication dans le Journal officiel de l'Union européenne):

La máquina descrita arriba cumple con las siguientes directivas de la CE/UE (publicados en el Diario oficial de la Unión Europea):

Le macchine sopra descritte sono conforme alle seguenti direttive CE/UE (secondo la pubblicazione nella Gazzetta ufficiale della Commissione europea):

Машина, указанная выше, полностью соответствует следующим регламентам ЕС/ЕУ (опубликованным в Официальном журнале Европейского Содружества):

- **2006/42/EC**
Maschinenrichtlinie 2006/42/EG / Machinery directive 2006/42/EC / Directive Machines 2006/42/EC / Directiva 2006/42/CE (Máquinas) / Direttiva macchine 2006/42/CE / Директива о машинах 2006/42/EC
- **2014/30/EU**
EMV-Richtlinie 2014/30/EU / EMC Directive 2014/30/EU / Directive CEM 2014/30/UE / Directiva CEM 2014/30/UE / Direttiva EMC 2014/30/UE / Директива ЗМС 2014/30/EU
- **2011/65/EU**
RoHS-Richtlinie 2011/65/EU / RoHS Directive 2011/65/EU / Directive RoHS 2011/65/UE / Directiva RoHS 2011/65/UE / Direttiva RoHS 2011/65/UE / Директива RoHS 2011/65/EU

1 / 3

BINDER GmbH Postfach 102 D-78532 Tuttlingen Address: BINDER GmbH, Im Mittleren Ösch 5, 78532 Tuttlingen, Germany
 Contact: Phone: +49 (0) 71 82 / 20 00 - 0 | Fax: +49 (0) 71 82 / 20 00 - 100 | info@binder.com | www.binder.com
 Managing Director: Dr.-Ing. Peter M. Binder | Director of Sales: HFF 707100 | Company Head Office: Tuttlingen, Germany
 Payment Details: Kreditinstitut: Tuttlingen Account No.: 2596 | IBAN: 603 200 70 | IBAN Code: 002804 00700 00000000 | SWIFT Code: SOLA DE 3311
 S-Account No.: 2000 611 06 | IBAN Code: DE44 44320070 000 251 195 | SWIFT Code: SOLA DE 3311
 Deutsche Bank Tuttlingen Account No.: 2 136 701 | IBAN: 605 700 70 | IBAN Code: 002803 7070 0213670000 | SWIFT Code: 3301 DE 3303
 Recycling of old equipment according to WEEE Reg. no. DE 37004982

Die oben beschriebenen Maschinen entsprechen aufgrund ihrer Konzipierung und Bauart sowie in der von uns in Verkehr gebrachten Ausführung den einschlägigen grundlegenden Sicherheits- und Gesundheitsanforderungen der genannten EG/EU-Richtlinien.

The machines described above are conform to the mentioned EC/EU directives in regard to the relevant safety and health demands due to their conception and style of construction as well as to the version put onto market by us.

Les machines décrites ci-dessus correspondent aux demandes de sécurité et de santé des directives citées de la CE/UE due à leur conception et construction et dans la réalisation mise sur le marché par nous.

Las máquinas descritas arriba se corresponden con los requisitos básicos pertinentes de seguridad y salud de las citadas directivas de la CE/UE debido a su concepción y fabricación, así como a la realización llevada a cabo por nosotros.

Le macchine sopra descritte sono conforme ai requisiti essenziali di sanità e sicurezza pertinenti delle summenzionate direttive CE/UE in termini di progettazione, tipo di costruzione ed esecuzione messa da noi in circolazione.

Машины описано выше, соответствует указанным директивам ЕС/ЕУ в отношении требований соответствующей безопасности и здоровья по концепции и конструкции так же как и версия, применяемая нами на рынке.

Die oben beschriebenen Maschinen tragen entsprechend die Kennzeichnung CE.

The machines described above, corresponding to this, bear the CE-mark.

Les machines décrits ci-dessus, en correspondance, portent l'indication CE.

Las máquinas descritas arriba, en conformidad, llevan la indicación CE.

Le macchine sopra descritte sono contrassegnate dal marchio CE.

Машины описано выше, в соответствии с изложенным выше маркированы знаком CE.

Die oben beschriebenen Maschinen sind konform mit folgenden harmonisierten Normen:

The machines described above are in conformity with the following harmonized standards:

Les machines décrits ci-dessus sont conformes aux normes harmonisées suivantes:

Las máquinas descritas arriba cumplen con las siguientes normas:

Le macchine sopra descritte sono conforme alle seguenti normative armonizzate:

Машины описано выше, полностью соответствуют следующим стандартам:

Sicherheit / Safety / Sécurité / Seguridad / Sicurezza / Нормативы по безопасности
<ul style="list-style-type: none"> • EN ISO 12100:2010 + Corr. 1:2011 • EN ISO 13732-1:2008 • EN 60204-1:2006 + A1:2009 + Corr. :2010
EMV / EMC / CEM / CEM / EMC / ZMC
<ul style="list-style-type: none"> • EN 61326-1:2013
RoHS
<ul style="list-style-type: none"> • EN 50581:2012

78532 Tuttlingen, 03.07.2017
BINDER GmbH



P. M. Binder

Geschäftsführender Gesellschafter
Managing Director
Directeur général
Director general
Direttore Generale
Директор



J. Bollaender

Leiter F & E und Dokumentationsbeauftragter
Director R & D and documentation representative
Chef de service R&D et autorisé de documentation
Responsable I & D y representante de documentación
Direttore R & D e responsabile della documentazione
Глава департамента R&D представитель документации

3 / 3

BINDER GmbH | Postfach 102 | D-78532 Tuttlingen | **Address:** BINDER GmbH | ex-Ströwen Ösch 2 | 78532 Tuttlingen | Germany
Contact: Phone: +49 (0) 74 62 7 20 20 - 0 | Fax: +49 (0) 74 62 7 20 00 - 100 | info@binder-world.com | www.binder-world.com
Managing Director: Dipl.-Ing. Peter M. Binder | Peter.M.Binder@binder.com, HRB 727190 | **Company Head Office:** Tuttlingen | Germany
Payment Details: **Kontopartner:** Tuttlingen | **Account no.:** 2399 | **IBAN:** 643 850 70 | **IBAN Code:** 0603043 643000 000002289 | **SWIFT Code:** SOLA DE 3311UT
S-Account no.: 2329 671 55 | **IBAN Code:** 0603043 643000 000002289 | **SWIFT Code:** SOLA DE 3311UT
Deutsche Bank Tuttlingen: **Account no.:** 2 138 700 | **IBAN:** 653 700 75 | **IBAN Code:** 0603043 643000 000002289 | **SWIFT Code:** 2221 DE 330303
Handling of old equipment according to WEEE-Reg.-no. DE 31554683

26.4 Certificate for the GS mark of conformity of the “Deutsche Gesetzliche Unfallversicherung e.V.“ (German Social Accident Insurance) DGUV



DGUV Test
Prüf- und Zertifizierungsstelle
Nahrungsmittel und Verpackung
Fachbereich Nahrungsmittel

Bescheinigung
Nr. **NV 15127**
vom 17.06.2015

GS-Zertifikat

Name und Anschrift des Bescheinigungsinhabers: (Auftraggeber)	Binder GmbH Im Mittleren Ösch 5 78532 Tuttlingen
Produktbezeichnung:	Klimaschränke Klima- und Kühlbrutschränke
Typ:	KBF P 240, KBF P 720, KBF LQC 240, KBF LQC 720, KBWF 240, KBWF 720, KBF 115, KBF 240, KBF 720, KMF 115, KMF 240, KMF 720, KBW 240, KBW 400, KBW 720, KB 23, KB 53, KB 115, KB 240, KB 400, KB 720, KBF 1020
Prüfgrundlage:	GS-NV 5:2013/06 Prüfgrundsätze für Kühl- und Gefriermaschinen für Industrie und Gewerbe
Zugehöriger Prüfbericht:	NV 15127
Weitere Angaben:	Das Zertifikat bezieht sich auf die im zugehörigen Prüfbericht beschriebene Ausführung des Produkts.

Das geprüfte Baumuster stimmt mit den in § 21 Absatz 1 des Produktsicherheitsgesetzes genannten Anforderungen überein. Der Bescheinigungsinhaber ist berechtigt, das umseitig abgebildete GS-Zeichen an den mit dem geprüften Baumuster übereinstimmenden Produkten anzubringen. Der Bescheinigungsinhaber hat dabei die umseitig aufgeführten Bedingungen zu beachten.

Diese Bescheinigung einschließlich der Berechtigung zur Anbringung des GS-Zeichens ist gültig bis:

16.06.2020

Weiteres über die Gültigkeit, eine Gültigkeitsverlängerung und andere Bedingungen regelt die Prüf- und Zertifizierungsordnung.



Deutsche Gesetzliche Unfallversicherung (DGUV) e.V.
Spitzenverband der gesetzlichen Berufsgenossenschaften
und der Unfallversicherungsträger der öffentlichen Hand
Verwaltungs-Nr. VL 70 B, Antrags-Nr. 04000000

DGUV Test Prüf- und Zertifizierungsstelle Nahrungsmittel und Verpackung
Fachbereich Nahrungsmittel
Dynamenstraße 7-11 • 40745 Mönchengladbach • Deutschland
Telefon: +49 (0) 21 44 56-34 30 • Fax: +49 (0) 20 800 1877 515 9625

Rückseite GS-Zertifikat: NV 15127

GS-Zeichen



Normalausführung



Bei einer Höhe von 20 mm oder weniger
auch zulässige Ausführung

1) Bescheinigungs-Nummer

1. Der Bescheinigungsinhaber hat die Voraussetzungen einzuhalten, die bei der Herstellung des umseitig genannten Produktes zu beachten sind, um die Übereinstimmung mit dem geprüften Baumuster zu gewährleisten.
2. Die Prüf- und Zertifizierungsstelle des Fachbereichs Nahrungsmittel führt in regelmäßigen Abständen Kontrollmaßnahmen zur Überwachung der Herstellung und rechtmäßigen Verwendung des GS-Zeichens durch.
3. Die für die Herstellung verantwortliche Person hat sich zur Einhaltung der Voraussetzungen nach Nummer 1 und Duldung der Kontrollmaßnahmen verpflichtet.
4. Die Prüf- und Zertifizierungsstelle entzieht dem Bescheinigungsinhaber die Zuerkennung des GS-Zeichens, wenn sich die Anforderungen nach § 21 Absatz 1 Produktsicherheitsgesetz geändert haben oder die Voraussetzungen nach Nummer 1 nicht eingehalten werden.
5. Das GS-Zeichen darf nur verwendet und mit ihm darf nur geworben werden, wenn die Voraussetzungen nach § 22 Produktsicherheitsgesetz erfüllt sind.

27. Product registration

27.1 Registering a BINDER chamber

Online Product Registration

Register your BINDER now!

www.binder-world.com/register

The registration is free and takes just a few seconds

Advantages:

- ▶ Short response times if service is needed
- ▶ Fair prices when relocating or installing equipment
- ▶ Calibration as required at no charge in case of recalls
- ▶ Free information on news, product upgrades and accessories

Easy registered in 3 steps:



1. List serial number here:

-

2. Go online: www.binder-world.com/register

3. Register serial number

27.2 KBF P / KBF P-UL / KBF LQC / KBF LQC-UL: Multi Management Software APT-COM™ 4 BASIC-Edition

Register now for getting your free BINDER Multi Management Software APT-COM™ 4 BASIC-Edition



With the purchase of your BINDER chamber KBF P / KBF P-UL / KBF LQC / KBF LQC-UL you will receive the **BINDER Multi Management Software APT-COM4™ 4 BASIC-Edition** for free.

BINDER's new Multi Management Software provides management, logging, programming and documentation options and much more.

Important characteristics of **APT-COM™ 4 BASIC-Edition**:

- Administration of up to five connected chambers
- Log management (creating, deleting, archiving)
- Documentation of recording values
- Central overview of all chambers in both graphic and tabular form
- Graphical presentation of recording values
- Graphical/numerical program editor
- Manual export of recording values (CSV/PDF file)
- Multilingual user interface (German, English, French, Spanish, Italian)
- Optional program execution via APT-COM™
- Timer function
- Import of data from APT-COM™ 3

Register your chamber today and request your personal software serial number.

Click here to register:

<https://www.binder-world.com/en/service-support/product-registration>

28. Contamination clearance certificate

28.1 For chambers located outside USA and Canada

Declaration regarding safety and health

Erklärung zur Sicherheit und gesundheitlichen Unbedenklichkeit

The German Ordinance on Hazardous Substances (GefStofV), and the regulations regarding safety at the workplace, require that this form be filled out for all products that are returned to us, so that the safety and the health of our employees can be guaranteed

Die Sicherheit und Gesundheit unserer Mitarbeiter, die Gefahrstoffverordnung GefStofV und die Vorschriften zur Sicherheit am Arbeitsplatz machen es erforderlich, dass dieses Formblatt für alle Produkte, die an uns zurückgeschickt werden, ausgefüllt wird.



Note: A repair is not possible without a completely filled out form.
Ohne Vorliegen des vollständig ausgefüllten Formblattes ist eine Reparatur nicht möglich.

- A completely filled out form must be transmitted via Fax (+49 (0) 7462 2005 93555) or by letter in advance, so that this information is available before the equipment/component part arrives. A second copy of this form must accompany the equipment/component part. In addition, the carrier should be notified.

Eine vollständig ausgefüllte Kopie dieses Formblattes soll per Fax unter Nr. +49 (0) 7462 2005 93555 oder Brief vorab an uns gesandt werden, so dass die Information vorliegt, bevor das Gerät/Bauteil eintrifft. Eine weitere Kopie soll dem Gerät/Bauteil beigelegt sein. Ggf. ist die Spedition zu informieren.

- Incomplete information or non-conformity with this procedure will inevitably lead to substantial delays in processing. Please understand the reason for this measure, which lies outside our area of influence, and will help us to speed up this procedure.

Unvollständige Angaben oder Nichteinhalten dieses Ablaufs führen zwangsläufig zu beträchtlichen Verzögerungen in der Abwicklung. Bitte haben Sie Verständnis für Maßnahmen, die außerhalb unserer Einflussmöglichkeiten liegen und helfen Sie mit, den Ablauf zu beschleunigen.

- **Please print and fill out this form completely**

Bitte unbedingt vollständig ausfüllen!

1.	Unit/ component part / type / Gerät / Bauteil / Typ:
2.	Serial No. / Serien-Nr.:
3.	Details about utilized substances / biological substances / Einzelheiten über die eingesetzten Substanzen/biologische Materialien:
3.1	Designations / Bezeichnungen:
a)	_____
b)	_____
c)	_____
3.2	Safety measures required for handling these substances / Vorsichtsmaßnahmen beim Umgang mit diesen Stoffen:
a)	_____
b)	_____
c)	_____

3.3	Measures to be taken in case of skin contact or release into the atmosphere / Maßnahmen bei Personenkontakt oder Freisetzung:
a)	_____
b)	_____
c)	_____
d)	_____
3.4	Other important information that must be taken into account / Weitere zu beachtende und wichtige Informationen:
a)	_____
b)	_____
c)	_____
4.	Declaration on the risk of these substances (please checkmark the applicable items) / Erklärung zur Gefährlichkeit der Stoffe (bitte Zutreffendes ankreuzen) :
<input type="checkbox"/>	4.1 For non toxic, non radioactive, biologically harmless materials / für nicht giftige, nicht radioaktive, biologisch ungefährliche Stoffe: We hereby guarantee that the above-mentioned unit / component part... / Wir versichern, dass o.g. Gerät/Bauteil...
<input type="checkbox"/>	Has not been exposed to or contains any toxic or otherwise hazardous substances / weder giftige noch sonstige gefährliche Stoffe enthält oder solche anhaften.
<input type="checkbox"/>	That eventually generated reaction products are non-toxic and also do not represent a hazard / auch evtl. entstandene Reaktionsprodukte weder giftig sind noch sonst eine Gefährdung darstellen.
<input type="checkbox"/>	Eventual residues of hazardous substances have been removed / evtl. Rückstände von Gefahrstoffen entfernt wurden.
<input type="checkbox"/>	4.2 For toxic, radioactive, biologically harmful or hazardous substances, or any other hazardous materials / für giftige, radioaktive, biologisch bedenkliche bzw. gefährliche Stoffe oder anderweitig gefährliche Stoffe. We hereby guarantee that ... / Wir versichern, dass ...
<input type="checkbox"/>	The hazardous substances, which have come into contact with the above-mentioned equipment / component part, have been completely listed under item 3.1 and that all information in this regard is complete / die gefährlichen Stoffe, die mit dem o.g. Gerät/Bauteil in Kontakt kamen, in 3.1 aufgelistet sind und alle Angaben vollständig sind.
<input type="checkbox"/>	That the unit /component part has not been in contact with radioactivity / das Gerät/Bauteil nicht mit Radioaktivität in Berührung kam
5.	Kind of transport / transporter / Transportweg/Spediteur: Transport by (means and name of transport company, etc.) / Versendung durch (Name Spediteur o.ä.) _____ Date of dispatch to BINDER GmbH / Tag der Absendung an BINDER GmbH: _____

We hereby declare that the following measures have been taken / Wir erklären, dass folgende Maßnahmen getroffen wurden:

- Hazardous substances were removed from the unit including component parts, so that no hazard exists for any person in the handling or repair of these items / das Gerät/Bauteil wurde von Gefahrstoffen befreit, so dass bei Handhabung/Reparaturen für die betreffenden Person keinerlei Gefährdung besteht
- The unit was securely packaged and properly identified / das Gerät wurde sicher verpackt und vollständig gekennzeichnet.
- Information about the hazardousness of the shipment (if required) has been provided to the transporter / der Spediteur wurde (falls vorgeschrieben) über die Gefährlichkeit der Sendung informiert.

We hereby commit ourselves and guarantee that we will indemnify BINDER GmbH for all damages that are a consequence of incomplete or incorrect information provided by us, and that we will exempt BINDER GmbH from eventual damage claims by third parties./ Wir versichern, dass wir gegenüber BINDER für jeden Schaden, der durch unvollständige und unrichtige Angaben entsteht, haften und BINDER gegen eventuell entstehende Schadenansprüche Dritter freistellen.

We are aware that, in accordance with Article 823 of the German Civil Code (BGB), we are directly liable with regard to third parties, in this instance especially the employees of BINDER GmbH, who have been entrusted with the handling / repair of the unit / component. / Es ist uns bekannt, dass wir gegenüber Dritten – hier insbesondere mit der Handhabung/Reparatur des Geräts/des Bauteils betraute Mitarbeiter der Firma BINDER – gemäß §823 BGB direkt haften

Name: _____

Position/ Title: _____

Date / Datum: _____

Signature / Unterschrift: _____

Company stamp / Firmenstempel:



Equipment that is returned to the factory for repair must be accompanied by a completely filled out contamination clearance certificate. For service and maintenance on site, such a contamination clearance certificate must be submitted to the service technician before the start of any work. No repair or maintenance of the equipment is possible, without a properly filled out contamination clearance certificate.

28.2 For chambers located in USA and Canada

Product Return Authorization Request

Please complete this form and the Customer Decontamination Declaration (next 2 pages) and attach the required pictures. E-mail to: IDL_SalesOrderProcessing_USA@binder-world.com

After we have received and reviewed the complete information we will decide on the issue of a RMA number. Please be aware that size specifications, voltage specifications as well as performance specifications are available on the internet at www.binder-world.us at any time.

Take notice of shipping laws and regulations.

	Please fill:	
Reason for return request	<input type="radio"/> Duplicate order	
	<input type="radio"/> Duplicate shipment	
	<input type="radio"/> Demo	<i>Page one completed by sales</i>
	<input type="radio"/> Power Plug / Voltage	115V / 230 V / 208 V / 240V
	<input type="radio"/> Size does not fit space	
	<input type="radio"/> Transport Damage	Shock watch tripped? (<i>pictures</i>)
	<input type="radio"/> Other (specify below)	

Is there a replacement PO?	<input type="radio"/> Yes <input type="radio"/> No	
<i>If yes -> PO #</i>		
<i>If yes -> Date PO placed</i>		
Purchase order number		
BINDER model number		
BINDER serial number		
Date unit was received		
Was the unit unboxed?	<input type="radio"/> Yes <input type="radio"/> No	
Was the unit plugged in?	<input type="radio"/> Yes <input type="radio"/> No	
Was the unit in operation?	<input type="radio"/> Yes <input type="radio"/> No	
<i>Pictures of unit attached?</i>	<input type="radio"/> Yes <input type="radio"/> No	Pictures have to be attached!
<i>Pictures of Packaging attached?</i>	<input type="radio"/> Yes <input type="radio"/> No	

	Customer Contact Information	Distributor Contact Information
Name		
Company		
Address		
Phone		
E-mail		

Customer (End User) Decontamination Declaration

Health and Hazard Safety declaration

To protect the health of our employees and the safety at the workplace, we require that this form is completed by the user for all products and parts that are returned to us. (Distributors or Service Organizations cannot sign this form)

	<p>NO RMA number will be issued without a completed form. Products or parts returned to our NY warehouse without a RMA number will be refused at the dock.</p>
---	--

A second copy of the completed form must be attached to the outside of the shipping box.

1.	Unit/ component part / type:
2.	Serial No.
3.	List any exposure to hazardous liquids, gasses or substances and radioactive material
3.1	List with MSDS sheets attached where available or needed (if there is not enough space available below, please attach a page):
a)	_____
b)	_____
c)	_____
3.2	Safety measures required for handling the list under 3.1
a)	_____
b)	_____
c)	_____
3.3	Measures to be taken in case of skin contact or release into the atmosphere:
a)	_____
b)	_____
c)	_____
d)	_____
3.4	Other important information that must be considered:
a)	_____
b)	_____
c)	_____

4. Declaration of Decontamination

For toxic, radioactive, biologically and chemically harmful or hazardous substances, or any other hazardous materials.

We hereby guarantee that

- 4.1 Any hazardous substances, which have come into contact with the above-mentioned equipment / component part, have been completely listed under item 3.1 and that all information in this regard is complete.
- 4.2 That the unit /component part has not been in contact with radioactivity
- 4.3 Any Hazardous substances were removed from the unit / component part, so that no hazard exists for a persons in the shipping, handling or repair of these returned unit
- 4.4 The unit was securely packaged in the original undamaged packaging and properly identified on the outside of the packaging material with the unit designation, the RMA number and a copy of this declaration.
- 4.5 Shipping laws and regulations have not been violated.

I hereby commit and guarantee that we will indemnify BINDER Inc. for all damages that are a consequence of incomplete or incorrect information provided by us, and that we will indemnify and hold harmless BINDER Inc. from eventual damage claims by third parties.

Name: _____

Position: _____

Company: _____

Address: _____

Phone #: _____

Email: _____

Date: _____

Signature: _____



Equipment returned to the NY warehouse for repair must be accompanied by a completed customer decontamination declaration. For service and maintenance works on site, such a customer decontamination declaration must be submitted to the service technician before the start of work. No repair or maintenance of the equipment is possible without a completed form.