

# OLYMPUS

Your Vision, Our Future

Life Science Microscopes

**BX43, BX46**

BX3 Clinical Microscope Systems

Clinical Microscopy: Built by Your Needs





## YOUR PERFECT MICROSCOPE NOW AND FOREVER

### Flexible and future ready

The Olympus BX3 series of clinical microscopes offers a wide range of capabilities to meet the expanding microscope applications and observation methods, both for today and the future. Olympus's clinical microscopes, cameras and software provide significant improvements and technological advances in key areas, such as system flexibility, ergonomics and imaging. Each BX3 microscope platform is designed to enable users to fully benefit from Olympus's ergonomic approach and the high performance of the UIS2 optics, resulting in greater productivity and user comfort with uncompromising quality and versatility.





# UNCOMPROMISING CLARITY AND CONTROL

## Productivity and comfort for high-throughput clinical microscopy

Clinical microscopy is about more than just microscopy; it's about many different procedures and the increasing importance of digital documentation as well. As a result, the microscope must not only be highly flexible, but also be designed with the user and the lab workflow in mind, as well as providing an extensive return on investment over many years. The Olympus BX3 clinical microscope systems are peerless in all these areas, offering excellent workspace adaptability and modularity, as well as uncompromised quality and versatility coupled with superb optics. Therefore, you will always remain in control, whatever the task and however your work changes.



### Your imaging platform

**6–21**

With groundbreaking optics, illumination and microscope frames, the BX3 range is unmatched in providing you with everything you need to define the best system for your workflow.



### Future-lab-ready: system solutions

**22–31**

With peerless software and a range of colour-coordinated microscopy cameras, the BX3 microscope range is the ultimate starting point for extended imaging systems.

## Your successful future

Olympus is dedicated to making state-of-the-art microscopes and accessories to support your work on all levels. We have therefore worked closely with customers to produce the ultimate in flexible microscopy – the BX3 range. As a result, our goal is your success, both now and in the future.



## YOUR IMAGING PLATFORM

### Efficient, effective and ergonomic workspaces

Olympus has redefined the standard for clinical microscopy, with class-leading optics and functionality, coupled with an amazing level of flexibility and adaptability. With Olympus's intricate attention to detail, your microscopy tasks will become a joyous part of your day. For example, the new colour-balanced LED illumination system makes the switch to an economic yet highly reliable light source exceptionally easy.



**A** LED

True-colour LED illumination

**B** LED lamphouse

Featuring advanced mixed-matrix brightfield LED technology

**C** Typical construction

Of a high-performance LED

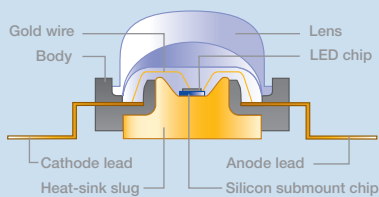

## LED-ING THE WAY

Light is always required for optical microscopy – even for the so-called dark-field technique. But providing effective illumination for the various microscopy techniques isn't as simple as shining a light at a mirror under the sample! Modern microscopy requires dedicated illumination solutions matched to the needs of the application. Light emitting diodes have been increasingly adopted as the “future” of lighting in various different settings, but the specific requirements of microscopy have necessitated a concomitant improvement in the technology. Olympus has made this much-needed breakthrough with a bright-field LED illumination system balanced to your clinical needs.

### The future of brightfield

**A – C** Even with the advent of highly advanced fluorescence microscopy techniques, brightfield observation is still the most important procedure in everyday microscopy. Olympus is taking brightfield to the next level with the most advanced mixed-matrix brightfield LED technology currently available. This new true-colour LED has been designed to provide a colour rendering index very similar to that of halogen bulbs with daylight filters. This means that stain colours appear exactly the same under the true-colour LED as they do under daylight filtered halogen, and also that similar (but not identical) colours can be clearly differentiated. Such clarity cannot be provided by standard LEDs as they cannot provide the same colour rendering capabilities and diagnostic imaging thus becomes difficult. This advanced colour rendering technology therefore provides a wavelength range ideal for the most commonly used stain colours – purple, blue and red (e.g. haematoxylin and eosin – HE, and Papanicolaou – Pap).

### Benefits

This not only provides optimum continuity when moving to a new microscope, but also a number of other clear benefits. These include precise intensity control by simply varying the voltage, since LEDs provide the same colour temperature whatever the intensity. Halogen bulbs vary greatly as the power input changes and therefore rely on ND filters to vary the illumination intensity. Furthermore, the LEDs require very little power and have excellent longevity, greatly exceeding the lifetime of all other light sources and making them almost maintenance-free. As a result they provide very low running costs and are much more environmentally friendly at every stage.

### Spectral characteristics of different light sources

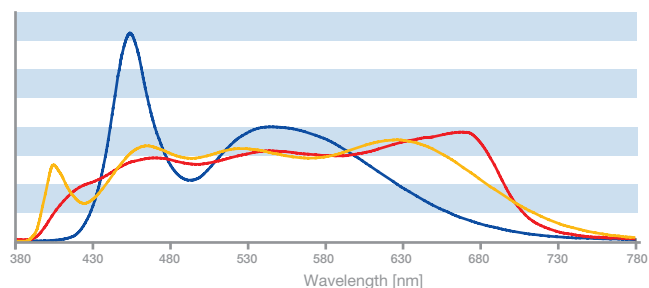

- Conventional white LED
- Halogen lamp + daylight filter
- BX3 true-colour LED



## Controlled transmission

Due to their nature, LEDs are ideal for transmitted brightfield illumination as they offer easy intensity control, with a constant colour temperature profile over the entire intensity range. Olympus has maximised this distinct benefit with the built-in Light Intensity Manager (LIM), which provides an easy-to-use interface for setting and automating brightness levels associated with each different objective, reducing the fine adjustments usually completed by the user with each objective.

## Managing light

**D** It is an optical fact that different magnifications require different illumination intensities to maintain the same overall brightness in the field of view. When screening a sample it is not unusual to move up and down repeatedly through the available objectives, which also means changing the light intensity with each turn of the nose-piece to keep the same brightness. This adds up to a lot of time spent adjusting the intensity over an entire day of screening samples. The Olympus LIM works in collaboration with the unique Olympus true-colour LED transmitted light source and coded nosepiece, to automatically adjust the illumination intensity to the user's predefined levels with each objective change.

As a result, once set the Light Intensity Manager enables excellent time savings and makes microscopy much more efficient. In addition, user fatigue is reduced during cytological examinations, allowing faster and more accurate screening of specimens with significantly reduced eye strain.



Integrated light intensity management on BX43

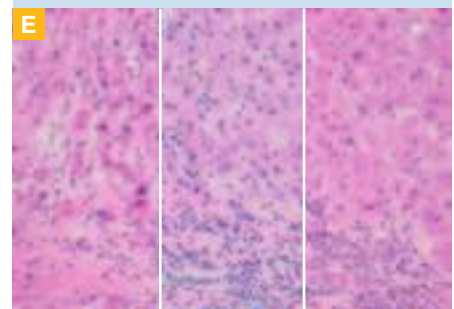

Illumination comparison: halogen/conventional LED/new BX3 true-colour LED



- A** Olympus UIS2  
Superior optical system

**UIS2**  
World-leading optics

- B** 20x PLN  
Plan achromat objective for cytology



- C** UPlanFLN  
Plan fluorite objective



- D** UPlanSApo  
Spectral apochromat objective



## YOU AND UIS2

**A** The Olympus UIS2 optical system is more than just a range of objectives and filters. It is an optical concept developed specifically for microscopy, with an extensive number of features balanced perfectly with the requirements of the application. The UIS2 system sets a new standard in precision and clarity and therefore offers ultimate flexibility to enable increased efficiency and more reliable results.

### Plan objectives for clear images

**B** Olympus has an extensive range of different objectives to cover every demand and application. For screening of histochemically stained specimens, the PLN series objectives are ideally suited, whereas for applications demanding a higher degree of chromatic correction, such as pathology screening, the UPLFLN and SAPO objectives are available. Whichever objective you decide to use to suit your needs, you can be assured that you will achieve bright and crisp images across the entire field of view with excellent flatness. Furthermore, a number of “no-cover” objectives are ideal for observing smear specimens (e.g. blood) without requiring a cover glass.

### Magnification change without changing light intensity

The Olympus PLNCY series of UIS2 microscope objectives is specifically designed for all clinical laboratory and examination work in both diagnostics and education when using halogen illumination. You can choose from a range of objectives covering 2x, 4x, 10x and 20x magnifications, and the built-in ND filter is designed for light balancing, allowing you to switch from low to high magnification quickly and effortlessly without adjusting the light intensity. As with the true-colour LED illumination system, the PLNCY prefiltered objectives enable a more convenient way of working in the clinical environment, saving valuable time when compared to using an objective and a separate ND filter.

### Spectral apochromat and fluorite

**C D** Pathologists can also benefit from the extensive fluorite (UPLFLN) and exquisite spectral apochromat (SAPO) objective series. The Olympus UIS2 fluorite objectives provide high quality across the entire range, which also includes many specially developed models for phase contrast, for example. The spectral apochromat objectives represent the cutting edge in high-end microscope optics with outstanding spherical and chromatic aberration correction. No other objective series ensures images with such excellent colour fidelity and resolution. For quality and performance, they offer an unbeatable solution for specimen visualisation including high-resolution DIC for investigation of ultra fine morphological details.

# CONTRAST: TO SEE OR NOT TO SEE

More than one method may be needed for the detailed observation of fine structures in cells. Many cells and structures in histological samples tend not to have inherent contrast visible under brightfield illumination, such as colour variations, whereas muscle and nerve tissue can be observed in amazing detail by using polarised light microscopy. The BX3 series of clinical microscopes and UIS2 optical components can be used for a comprehensive range of standard and contrast techniques to provide you with sharp and clear images for all routine screening requirements, such as phase contrast, differential interference contrast (DIC), darkfield, polarised light and fluorescence dyes.

## Brightfield

**E** Brightfield microscopy is the core technique of many screening procedures with a broad array of established dyes and staining procedures. The Olympus BX3 microscopes have been designed to be at the forefront of brightfield microscopy and its ongoing development. For example, the Olympus BX46 is designed to maximise every aspect of brightfield screening from very efficient illumination adjustment during objective changes and an ultra low minimal torque stage to three-dimensional observation tube adjustment.

## Phase contrast

**F** Phase contrast is the standard method used to observe cells in culture and has, like DIC, the capabilities to visualise dynamic events. In effect, the phase contrast technique employs an optical mechanism to convert minute variations in phase shift in the light passing through transparent specimen into corresponding changes in amplitude, which can be visualised as differences in image contrast.

## Fluorescence

**G** Fluorescence microscopy is becoming increasingly popular in clinical imaging, covering diverse conditions such as diagnosis of TB and genetic disorders (via MFISH). The Olympus BX3 range is well suited to fluorescence techniques, with a choice of fluorescence illuminators and a peerless range of objective and mirror cubes.

## DIC

**H** DIC provides the finest morphological detail by introducing contrast in essentially transparent specimens, rendering differences between features such as height information. Olympus has developed three DIC solutions to suit the needs of different users and samples. High-contrast DIC is ideal for thin samples where inherent contrast is very low, allowing for the identification of very fine structures, whereas high-resolution DIC is aimed more at thicker specimens where specimens possess more natural contrast. A universal DIC solution balances contrast and resolution to provide flexible DIC imaging where sample-to-sample thicknesses may vary more.

## Other key methods

**I** Many cells and structures can be imaged without the need for contrast media, such as dyes, by using polarised light microscopy. For example, muscle and nerve tissue, as well as actomyosin fibres and mitotic spindles can all be observed in amazing detail. Darkfield microscopy is different again: samples are illuminated obliquely, such that no directly transmitted light is observed. Instead only light that has been significantly refracted by the sample is collected and visualised.



Brightfield: histological section

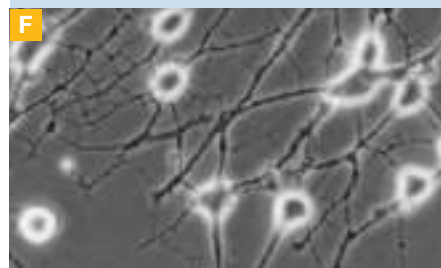

Phase contrast: astrocytes

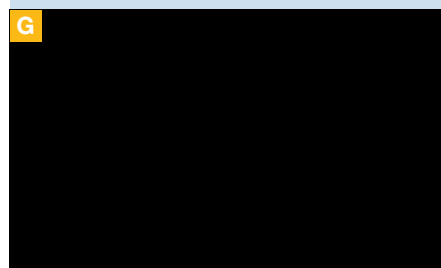

Fluorescence: TB diagnosis using auramine staining



DIC: mucosa cells

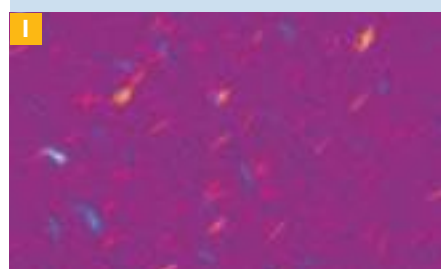

Polarisation: gout inspection



### B BX46 microscope

With ergonomic tube and DP21 digital camera



## KING OF ERGONOMICS

The BX46 was specifically designed to meet the rigorous demands of repetitive routine microscopy. In contrast to conventional microscopes, where samples are focused using a moving stage, the BX46 has a moveable objective nose-piece. This allows the stage to be fixed in the Z-plane very close to the desk surface and it is therefore in the same place relative to the user's hand at all times. The unmatched three-dimensional adaptability of the new observation tube also provides the ideal posture for the user. This unique BX46 microscope design shows the attention to detail used in the construction and ensures the highest levels of comfort for long-term screening.

### Posture perfect

**A B** The BX46 has been developed to enable the user to maintain the perfect, ergonomic posture all day, as shown above. This includes an upright back and neck, which allows the spinal column to assume its natural soft "S" curvature in the cervical, thoracic, lumbar and pelvic curves. Furthermore, the ultra low stage enables users to maintain the ergonomically correct 90-degree angle at the elbow, and the reduced torque of the stage ensures minimal force is required to navigate.

## Ergo tube

The correct posture is entirely different from person to person and it is therefore essential that the microscope can accommodate each user down to the millimetre. The Olympus BX3 telescopic, tilting, lifting observation tube provides this capability, enabling inclination angle, tube extension and tube height adjustment and thus fully flexible three-dimensional adjustment.

**C** Tube extension 0–55 mm

**D** Eyepiece tilt  $-3^{\circ}$  to  $+27^{\circ}$

**E** Lifting 0–45 mm





### **B** Ergo Grips For easy handling



### Ultra low stage

**A** The BX46 design is a complete departure from the standard upright microscope, offering a stage positioned only 128 mm above the desk surface – lower than any other microscope in this class. This has two very positive effects for the user: the stage is always at the same height and requires very little elevation of the hand and forearm from the desk to place and remove samples from the stage surface.

### An easy mover

**A B** In addition to its low, fixed height, the BX46 offers two further ergonomic features: a low torque mechanism and Ergo Grips on the XY controls, both reducing the force required to navigate around the sample. This is further improved through the low positioning of the stage controls, which means that the user doesn't need to lift their hand off the desk.

### Quick Capture

**E** A remote exposure knob can be mounted on either side of the microscope to allow image acquisition at the touch of a button without requiring the user to turn away from the microscope to look at the monitor and use the mouse. This is not only more efficient, but is also ergonomically better for the user.

## Three-dimensional adjustment

**C** Creating the perfect upright and comfortable posture during microscope operation is not only essential, but entirely dependent on the user. With the ergonomically perfected telescopic, tilting, lifting observation tube, the inclination angle, tube extension and tube height can be adjusted, allowing a fully flexible set-up in three dimensions. As a result the microscope can be adjusted to precisely match the user, rather than the other way round.

An additional ergonomic tube offering inclination angle and tube extension adjustment is available in two different versions. One model generates the conventional inverted observation image, whereas the other produces an erect observation image moving in the same direction as the specimen; this makes it easier to find a specific area in the specimen.

## Continuous observations

Continuous observation using objective magnifications from 4x to 100x is possible without the need to swing the condenser's front lens out of the light path. Since switching between these low magnification objectives is common for clinical screening, removing the swing-in/swing-out step makes screening far more efficient and the user can therefore save lots of time.

## Easy gout inspection

**D** The microscope can very easily and quickly be adapted for use in the detection of gout, since the analyser inserts directly into the nosepiece. For routine gout screening, a rotating stage can be mounted instead of the standard mechanical stage.

### **C** BX46

Ergonomic microscope



### **D**

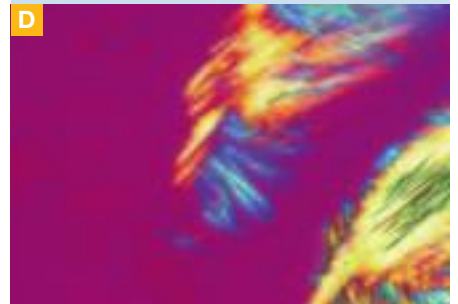

### **E**



**A** BX3 clinical system  
Future lab ready



## A GREAT TEAM PLAYER

**A – D** The BX43 offers an outstanding range of features and optical performance for the clinical market. With an emphasis on the powerful UIS2 optical system and the proven rigid, Y-shaped frame coupled with easy-to-operate front controls and unique colour-matched LED brightfield illumination, it also offers improved versatility and ergonomic operation. The compact space-efficient frame of the BX43 enables comprehensive routine work functions with outstanding cost-performance, making it an ideal and versatile stand-alone microscope for standard imaging applications, and also the perfect starting point for digital imaging, motorisation and even fluorescence – it is future-lab-ready so that you can be too.

### Imaging method – it's your choice

The BX43 provides the clinical screening environment with the ideal balance between a dedicated specialist and a flexible system. It is perfect for long-term brightfield screening and features the same UIS2 optics and colour-matched LED technology as the BX46, providing the best clarity possible. It is also ideal for expanding your imaging beyond brightfield with a series of condensers for contrast techniques and modules to support fluorescence imaging.



Integrated light intensity management

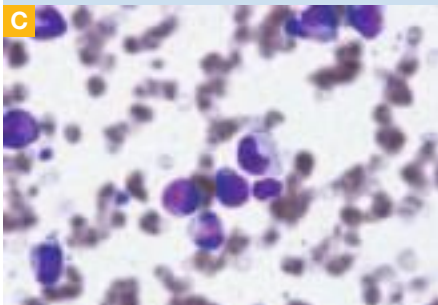

Application image: Bone marrow smear





## Condensers

**E–H** Olympus has developed a range of UIS2 condensers to suit every possible application. For the clinical field, where brightfield observation of stained specimens (such as HE-stained tissue sections) is core, Olympus has developed condensers with white tops, which enable users to position slides very easily by eye.

The BX43 is available with condensers to cover brightfield (BF), darkfield (DF) and phase contrast (PH), as well as a condenser specially designed for low magnification. In addition, a universal condenser is available for all these methods with inserts for DF, PH and even a special insert for 1.25x magnification.

The broad-range condenser is designed to meet the requirements of clinical bright-field observation. The unique optical design allows a magnification range from 2x to 100x without the need for a swing-out top lens. This is much more efficient and comfortable for the user as there is no need to swing a top lens in and out of the optical path when moving between objectives.

## Branching out

If modularity could be embodied, then it would take the form of the Olympus BX43 microscope. With the joint appeal of being both a timeless classic and cutting edge, the BX43 enables a level of adaptability not normally associated with clinical instrumentation. It is designed to incorporate an extended range of high-performance digital cameras, accessories and objectives, giving users greater freedom to build systems based on their needs. As a result the BX3 series is the ideal choice for the expanding range of observation methods used in the clinical field.

## Building your system

With the BX43 it is possible to start with a standard manual brightfield microscope set-up and then adapt the system as the requirements change. For example additional optical inserts and objectives could be added to cover a broader range of techniques and a trinocular observation tube makes it possible to add a digital imaging camera, which in turn makes the Olympus labSens software an excellent addition for digital documentation and case tracking. The BX43 can also support reflected fluorescence, ensuring that, with the increasing number of clinically relevant fluorescence techniques, your microscopy system can easily be adapted to suit your needs, whilst still providing the same transmitted white light capabilities.

Therefore, whichever system you create using your BX43, it will be perfect for the histological screening you are currently carrying out and will adapt to everything you do in the years ahead.

### **E** Abbe condenser

Suitable for magnifications from 4x to 100x



### **F** Broad-range condenser

Suitable for magnifications from 2x to 100x



### **G** Swing-out condenser

Suitable for magnifications from 1.25x to 100x



### **H** 8-position universal condenser

Allows brightfield, phase contrast, darkfield, polarised light and DIC observation



**A Encoded nosepieces**

With 5 and 7 positions

**B Fluorescence condenser**

Motorised, with 8 positions for filter cubes

**C Motorised universal condenser**

Automates switching between contrast methods

**D Motorised nosepiece**

With 7 positions



## FREEDOM OF CHOICE

By bringing together the right balance of modules and accessories, the BX3 clinical microscopes provide the freedom to fully investigate specimens. Olympus offers an impressive range of motorisation and automation tools for increasing the efficiency of routine and complex imaging and screening techniques. This offers the capability to perform more reliable examinations even more quickly, saving valuable time.

### Automatic readout

**A** The BX3 range features optional manual nosepiece and mirror turret modules which are encoded, enabling users to automatically record and share microscope magnification and setting information for comparing, measuring and scaling images. This readout provides the correct metadata automatically to the Olympus labSens and cellSens software packages, as well as the stand-alone DP21 digital imaging camera, ensuring no mistakes or scaling errors are made when documenting images.

### Motorised running

**B – E** Automated features increase work efficiency and save time by carrying out many of the instrument adjustments that the user would normally complete manually. The motorised 8-position universal condenser offers the potential to manage contrast efficiently and effectively. This is very important for moving quickly through the various transmitted light observation techniques. Importantly, condenser positions can be linked to objectives, such that when moving between magnifications, the microscope can automatically put the correct optical element in place (if a change is required). This automation is also designed to streamline the use of the 1.25x low-magnification objective, which requires a special insert for even illumination as well as the top lens of the condenser swung out – both of which are automated when the objective is selected.

Changing to the objective of choice can be achieved very efficiently by using either the convenient remote control handset or direct PC control (via the labSens software), ensuring that the correct objective is selected every time. This also allows the user to quickly determine any part of the specimen that needs closer attention. Each magnification is recorded immediately with each image.

### Modular approach

The automation options outlined work well in unison with each other, but can be implemented as independent solutions, so the user only has to motorise the function(s) they need to. This offers much greater flexibility and cost-efficiency, ensuring that the system is built to the user's requirements.

D



## Taking to the stage

**F** Another component that can be motorised and managed is the stage. A number of options are available from Olympus to motorise the XY movements. This enables easier specimen navigation, as well as allowing automatic imaging of multiple areas of interest, since motorised stages can be controlled by the labSens software.

## More than the microscope

The automation options available with the Olympus BX3 range provide outstanding optical performance and flexible expandability, giving you total freedom to build the system configuration of your choice and taking you to a higher level of microscopy and imaging. With the labSens software it is also possible to automate the full range of accessories, from digital cameras through to objective selection. As a result, the BX3 clinical microscope series offers user-defined system solutions – for all tasks from specimen examination and imaging acquisition through to analysis and processing.

### **E** Hand switch

Stand-alone control of motorised components



### **F** Motorised stage

For automated scanning of large specimens



## A Fluorescence condensers

Manual, encoded and motorised models



Easy replacement of filter cubes

## C Filter cubes

For fluorescence observation



# FLUORESCENCE IN DIAGNOSTICS

Fluorescence microscopy techniques have long been established as a key to life science research as they enable the pinpoint localisation of a target through the use of molecular dyes that fluoresce when illuminated with a defined wavelength of light. As a result, it is possible to identify, for example, whether a particular protein has been expressed and where it is located. This also offers great potential in a clinical setting and fluorescence techniques have become accepted in a number of areas. Fluorescence microscopy requires adaptations to the microscope system, with the addition of a source of fluorescence illumination, a series of wavelength and attenuation filters to provide defined wavelengths and intensity control, and dichroic mirrors to enable the illuminating light and emitted light to use the same optical path within the microscope without affecting visualisation.

## Fluorescence-lab-ready

**A B** The Olympus BX43 is perfectly suited for fluorescence and can be fitted with an 8-position fluorescence illuminator, which not only enables rapid filter cube changes without the need for tools, but also provides enough cube positions to cover techniques requiring multiple fluorescence wavelengths, such as multiple fluorescence *in situ* hybridisation (MFISH).

## Optically superior

**C** The new Olympus filters themselves have state-of-the-art coatings to provide high transmissions with sharp cut-offs, and the filter cubes are designed with low reflection surfaces to trap more than 99% of stray light. This maximises the signal-to-noise ratio (S/N) improving the imaging efficiency of the system. Also improving the S/N are the peerless UIS2 SAPO objectives, which provide exceptional transmission rates across the entire spectrum with very low autofluorescence. In addition to these advanced components, the low autofluorescence immersion oil further improves the quality of the image obtained.

Transmittance of fluorescence filter cubes

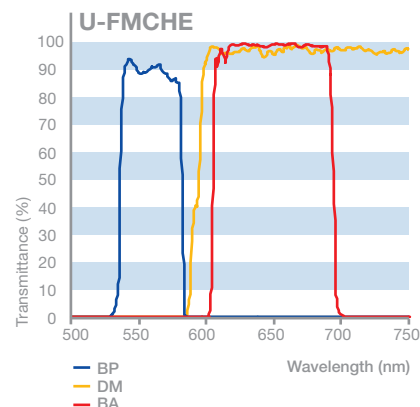
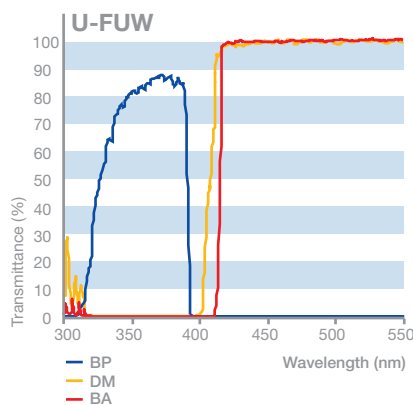

## FLEXIBLE AND ILLUMINATING

With Olympus UIS2 optical components providing the perfect pathways for both illumination and visualisation, it is essential to make the most of this with a range of carefully selected lighting options. Here, the Olympus BX3 series microscopes again excel with the flexibility of their offering, with increased sensitivity and efficiency of detection in routine pathology.

### Arc burner brilliance

**D** The BX3 frame supports the direct attachment of 100 W mercury, 100 W mercury apochromat and a 75 W xenon apochromat lamphouses, which provide easy alignment and straightforward operation. The BX3 range also provides the perfect platform for the more advanced EXFO X-Cite 120 arc burner range. These peerless modules provide the same fluorescence spectrum and similar intensities to standard mercury burners, but ensure an additional level of consistency and safety, making them excellent options for a broad range of requirements. The X-Cite range uses alignment-free metal halide burners and the unique metal halide technology ensures much of the tungsten eroded during “burning”, is recycled back to the electrodes. This slows down the widening of the arc gap, which in turn decreases the rate of intensity reduction. This, coupled with the electronic control gear (ECG), which ensures that as the gap between the electrodes grows the correct voltage is used to generate a consistent arc, greatly extends the life of the burner.

### Homogenous illumination

**E** It is important that the field of view is illuminated homogeneously, so that there is even fluorescence intensity across the entire field of view. To ensure that this happens, the Olympus fluorescence illuminators have been developed with a novel optical concept, based around a unique fly-eye lens system which provides uniform and even illumination through the entire spectrum. This fly-eye concept also ensures that the alignment of conventional mercury burners is much easier and quicker.

### Out in the LED

**F G** LEDs emit light within defined wavelength bands enabling precise excitation of fluorescent dyes. Furthermore, LEDs offer a very long lifetime (guaranteed minimum of 10,000 hours) with excellent lumen maintenance. They are robust, easy to handle, adjustment-free and have very low running costs due to their low power consumption, ensuring the best preconditions for all routine applications. The precisExcite LED fluorescence illumination systems from CoolLED provide market-leading intensities and over 20 wavelength selections, to ensure full coverage of all fluorophores.

#### **D** X-Cite 120PC

Metal halide fluorescence illumination system



**E** Fly-eye lens for homogeneous fluorescence illumination



**F** precisExcite: LED array modules

#### **G** precisExcite

LED fluorescence excitation light source





## FUTURE LAB READY: SYSTEM SOLUTIONS

### A system for you whatever your requirements

An increasing number of application areas require clinicians to capture, store and annotate the images they produce. As a result, even if these requirements are not currently needed the microscope you buy today should be ready for the digital future. With the Olympus BX3 microscopes, related accessories and digital camera range, as well as the dedicated labSens software, clinicians have the scope to match their current requirements, safe in the knowledge they are ready for the future, whichever direction it takes their imaging needs.



**A** Centrabale camera adapter

Easy alignment of binocular observation and camera image

**B** Olympus True Colour

OTC colour management

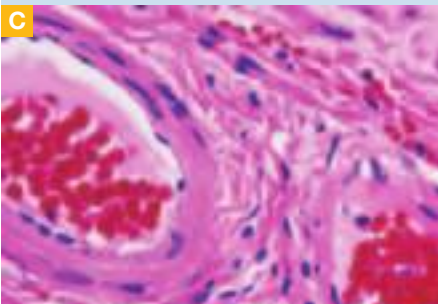

Histological section

## OPTIMISED FOR BOTH EYE AND CAMERA

With the changing requirements of clinical investigations comes the need to customise your equipment. With the versatile BX3 system, your microscope is more of an imaging platform and can therefore be tailored to your exact requirements. Olympus has developed a complete range of digital cameras for experimental procedures ranging from standard brightfield microscopy to advanced high-speed fluorescence. Built on the same exacting principles as its superior microscopes, the Olympus camera range enables you to feel confident with your choice of camera, ensuring the capture of histological stains with pixel-precise colour fidelity for all clinical diagnoses. With the knowledge that an excellent system for all clinical requirements is in place, you can maximise your imaging capabilities with confidence. Add to this selection the ability to pick from a range of image sizes and resolutions, and the Olympus digital microscope camera range really does offer you the flexibility of choice.

### Perfect colour fidelity

**B** The unique Olympus True Colour (OTC) system ensures that, whatever Olympus ultra colour (UC) or excellence colour (XC) microscope camera you use, the multiple colours present in histological samples are faithfully preserved and recorded, and look as natural as possible. The OTC system uses internal International Colour Consortium (ICC) reference profiles to ensure consistency between the input and output colours at every stage of the imaging process. These profiles are even applied in live mode to ensure the best possible colour representation at the highest speed.

### Enhanced functionality

Once you have found the perfect image, the next challenge is to capture it accurately, but what if you need to alter the parameters? When using the Olympus LabSens software alongside your camera, all of the function controls that you require are situated on-screen next to the image. The Olympus Camera Control (OCC) enables effortless and flexible control of all aspects of acquisition, from the storage and retrieval of specific camera settings to direct access to advanced acquisition functions. Even the most complex imaging tasks become simple, making digital microscope cameras easy for everyone to use.



## DP72 – unrivalled speed and clarity

**D** The Olympus DP72 digital camera is highly flexible and features advanced image-processing capabilities, making it ideal for pathology applications where faithful colour reproduction is essential for clear and consistent diagnoses. The outstanding 12.8-megapixel resolution will show your images in their finest detail, with natural colours as seen through the microscope eyepieces. The fast capture of high-resolution images is perfectly displayed with maximum performance for all imaging needs – from brightfield to advanced, high-speed fluorescence.

## UC30 – high resolution: sensitive touch

**E** The Olympus UC30 offers an excellent 3.2-megapixel resolution and fast frame rates with the added benefit of 2x and 3x colour binning, making it ideal for a broad range of imaging requirements. The colour CCD chip ensures users can see more and, as a result, measurements can be carried out with great precision and sensitivity, providing detection of even weak signals. The camera offers three frame rates: search mode with 34 fps. makes finding suitable areas of a sample very easy. Focus mode with 14 fps ensures that focusing can be carried out quickly and accurately. Full-resolution mode offers 5 images/sec at 3.2-megapixel resolution.

## SC30 – flexible and fast

**F** The Olympus SC30 uses a 3.3-megapixel CMOS chip, which is excellent for standard brightfield applications and simple digital documentation purposes. In conjunction with its excellent cost/performance ratio, the SC30 is the ideal introductory model for digital image acquisition using light microscopes. The SC30 has been designed for fast frame rates, so even at full resolution (2,084 x 1,532, 10 bits per colour channel), the camera can produce 11 fps. With various binning modes, which can be used to enhance sensitivity or for increasing frame rates, it can achieve 30 fps and 45 fps, made possible by using 2x and 4x binning respectively. Exposure times can be set from 57  $\mu$ s up to 1.75 s and the SC30 supports Olympus True Colour optimisation, ensuring that there is excellent colour fidelity.

## DP21 – stand-alone specialist

**G** With an ultra fast full-frame rate of 15 fps, the 2-megapixel Olympus DP21 digital microscopy camera offers a smooth and easy-to-view live display of the field of view. The stand-alone DP21 is designed to output directly to a high-resolution UXGA (1,600 x 1,200 pixels) monitor or projector, removing the need for a PC. The DP21 can also work with the encoded nosepiece and mirror turret modules to capture and record image acquisition metadata along the images. It is ideal for a broad range of biomedical, clinical, diagnostic and educational applications with its rapid, real-time live display, stunning colour and crisp detail. This is also a great camera for a wide range of end users who require a camera for documentation purposes including bright fluorescence.

### D DP72

Versatile high-resolution camera



### E UC30

High performance as standard



### F SC30

Fast and flexible



### G DP21

Stand-alone camera



**A Process manager**

Guided operation

**B Camera control**

All functions at a glance



## IMAGING AND DOCUMENTATION: LABSENS

With carefully selected microscope optics, illumination system and camera, it is possible to produce and record fantastic images on an Olympus BX3 microscope. But connecting all of these features together with software control not only makes imaging and analysis more efficient and precise, but also opens up new channels of investigation and maximises capabilities. To help make sense of microscope imaging, Olympus has introduced the dedicated labSens software, which not only provides the user with the ideal clinical imaging tools, but also ensures that it is highly intuitive even for inexperienced users.

### Modern digital documentation solution

The labSens software program is the ideal digital imaging and documentation solution for the modern clinical laboratory. As well as meeting all of the essential image acquisition, processing and discussion needs, labSens fits in with the BX3's central themes of ergonomics and efficiency. The easy-to-use graphical user interface enables the definition of the most important functions, such that users can choose which tools they would like to have available on the screen, enabling them to streamline the interface. This results in an instinctive and fast interactive environment for acquiring, displaying, commenting on, measuring and handling images.

### Image acquisition

**B** The labSens software provides the user with complete control over the most relevant Olympus digital microscopy cameras so that framing and capturing images becomes very straightforward, requiring just one click on the large clear icon. If the encoded nosepiece is installed on the microscope, the objective in use is automatically detected by the software so that the scale bar is set correctly and recorded correctly in the metadata of a captured image.

### Image processing

**C** The labSens software is designed to provide users with a number of essential image processing tools including rotation and cropping. It also enables users to perform multiple image alignment (MIA), as well as basic measurements (distances, areas). Importantly, labSens supports the addition of annotations, such as text and drawings.



## Image management

The labSens software manages images and associated metadata, enabling the user to query existing data. This capability can be expanded further with labSens Patho, offering excellent data security and full traceability.

## Automation

As well as integrating with the Olympus camera range and coded nosepiece, labSens provides full control for the user over other motorised components of the BX3 system, such as nosepieces, condensers and the stage. This provides further efficiency and ergonomic advantages for the user.

## Optional solutions

Importantly, labSens can be expanded through the implementation of additional hardware and software modules. For example, the software is designed to work with interactive touch screen computer monitors, which enable users to directly touch the on-screen icons. The incorporation of a barcode scanner provides support for clinical laboratories that are using barcoded slides for better data and patient tracking. The Netcam module enables live and stored images to be shared across a network. Also, if an Olympus VS110 virtual slide scanning system is installed, labSens can access the associated Net Image Server SQL database to provide completely integrated clinical services.

## labSens Patho

**D** The labSens Patho solution is an advanced documentation package for clinical results. The software includes the basic functionality of labSens with the addition of a workflow tool window for secure data entry, local databasing and connectivity to a number of external databases. labSens Patho uses a Microsoft SQL 2005 Express Edition client-server database, ensuring that images and associated data such as slide ID and clinical result information, as well as metadata, are managed in a clear and controllable way. This is ideal for implementing consistent data structure and clear documentation routines. Stored images and image information can be accessed directly from other systems or can be made available from anywhere in the network, which can improve the response times for labs to requests and the overall speed of internal communication.

## Motorised stage

**E** For laboratories that need large, high-resolution images, labSens can integrate with a motorised stage to enable semi-automated MIA.

### **D** labSens Patho

Intuitive workflow-oriented user interface



### **E** MIA

Multiple image alignment

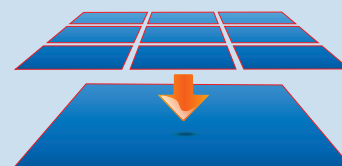

**A** NetCam: live images online  
Efficient web-based live image view

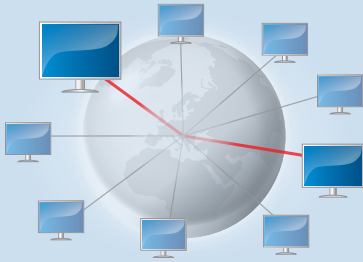

## EDUCATION AND DISCUSSION

It is essential that, when new people join, they can learn from the existing team. Making this as efficient as possible is a key goal for all training establishments. In the live environment, team discussions and case meetings are also highly important and facilitating these can require a number of different solutions.

### labSens discussion

**A** Imagine if it were possible to turn your microscope imaging system into a web-cam! With labSens this is not only possible, but also easy. Using standard TCP/IP protocols the labSens “NetCam solution” enables the transfer of live and stored images throughout the network for remote discussion, mentoring or supervision. From outside the lab, colleagues or supervisors can monitor the work from any point on the network, reducing waiting time. It is also the ideal solution for when managers are not able to directly attend the lab, but still need to mentor their staff. Olympus labSens also works with other standard software programs, enabling users to send images by email with labSens, as well as retrieve images easily from the structured database and even an Olympus VS110 Net Image Server SQL database if available.

### Group observation systems

**B** In addition to the ergonomic binocular and trinocular observation tubes, Olympus offers customisable dual-observation and multi-viewing attachments for laboratory discussions. These systems are also invaluable for clinical observations, teaching and instruction, which are much more efficient if the entire group can see the discussion specimen through an individual eyepiece. There is a wide choice, designed for two to ten or even more participants.

**B**



## VIRTUALISED MICROSCOPY

Virtual slide microscopy offers pathologists and researchers, as well as students in professional education, the unique potential to acquire complete slides at high magnification and resolution for the purpose of diagnosis, analysis and archiving of samples for discussion both remotely and in online conferences.

### A new way to teach

**C** The Olympus VS110 virtual slide scanner offers new ways of teaching students to analyse pathology samples by enabling the tutor to work with all students in real time and to analyse the same virtual sample as if they were using a real microscope. This flexibility of the virtual slide technology within all clinical applications and teaching environments enables users to exceed the limits of conventional digital microscopy and telepathology in both the size and the resolution of image files that can be discussed, as well as in the time and location of discussion with colleagues.

## STAND-ALONE IMAGING

**D** Sometimes it is not possible to have a computer next to the microscope, and with the Olympus DP21 digital camera it is not necessary! This stand-alone functionality means that the camera does not require any PC or network connections.

### Accurate colour rendering

The DP21 offers rapid, real-time live display, stunning colour and crisp detail, and is ideal for a broad range of biomedical, clinical, diagnostic and educational applications. The 2-megapixel DP21 uses a 1,200 x 1,600 pixel CCD and a 12-bit analogue-to-digital converter to display subtle colour differences, which is very important for accurate colour reproduction and outstanding fine detail. Furthermore, the operator can use the remote exposure button to capture images without looking up from the eyepieces. The button has a magnetic base and can therefore be placed securely anywhere on the microscope frame, providing additional flexibility for the user.

### Storage and networking

Pathologists, cytologists, haematologists and microbiologists will find the accurate colour reproduction of their specimens a welcome change. The intuitive control panel can be extended with a PC mouse and keyboard to ensure easy and accurate control of the various measurement and annotation functions. Furthermore, images can be stored directly on USB flash media or even transferred via a LAN connection to any storage point on your network.

### Presentation and discussion

The Olympus DP21 is the perfect image source for the presentation of microscopic images, since it can be directly connected to a large flat screen or projector. As a result it can be used to review and display the finest details of delicate specimens to multiple people simultaneously, or even display images to an entire auditorium during a presentation.

**C** Olympus VS110  
For virtual microscopy



**D** DP21 stand-alone camera  
With hand switch







## BX3 clinical specifications

	BX43	BX46
<b>Microscope frame</b>		
Optical system	UIS2 optical system	UIS2 optical system
Focus	Coaxial coarse and fine focus with stage up and down mechanism Focus stroke 25 mm Coarse stroke 15 mm/rotation Fine stroke 100 µm/rotation Graduation on fine focus 1 µm Prefocusing limit stopper and torque adjustment on coarse focus	Coaxial coarse and fine focus with objective up and down mechanism Focus stroke 15 mm Coarse stroke 15 mm/rotation Fine stroke 100 µm/rotation Graduation on fine focus 1 µm Prefocusing limit stopper and torque adjustment on coarse focus
Illuminator	Built-in Köhler illumination for transmitted light Light manager with individual light intensity settings for all objectives High colour-reproductivity LED light source Optional: 6 V, 30 W halogen bulb (pre-centred)	Built-in Köhler illumination for transmitted light Light manager with individual light intensity settings for all objectives High colour-reproductivity LED light source Optional: 6 V, 30 W halogen bulb (pre-centred)
<b>Revolving nosepiece</b>		
	Interchangeable reversed quintuple/sextuple/septuple nosepiece Encoding optional with quintuple and septuple nosepiece Motorised septuple revolving nosepiece	Fixed reversed quintuple nosepiece with encoding
<b>Observation tube</b>		
	Widefield tilting, telescopic and lifting binocular, inclined -3°-27° Widefield tilting trinocular, inclined 5°-35° Widefield trinocular, inclined 30° Widefield erect-image trinocular, inclined 30° Widefield tilting binocular, inclined 5°-35° Widefield ergo binocular, inclined 0°-25° Widefield binocular, inclined 30° Super widefield trinocular, inclined 24° Super widefield erect-image trinocular, inclined 24°	Widefield tilting, telescopic and lifting binocular, inclined -3°-27° Widefield tilting trinocular, inclined 5°-35° Widefield trinocular, inclined 30° Widefield erect-image trinocular, inclined 30° Widefield tilting binocular, inclined 5°-35° Widefield ergo binocular, inclined 0°-25° Widefield binocular, inclined 30°
<b>Stage</b>		
	Ceramic-coated coaxial stage with left or right-hand low drive control, with rotating mechanism and torque adjustment mechanism, optional Ergo Grips available (non-stick coated grooved coaxial, plain and rotatable stages are also available)	Ceramic-coated coaxial stage with left or right-hand low drive control, with rotating mechanism and torque adjustment mechanism (low torque, plain and rotating stages are also available)
<b>Condenser</b>		
	Swing-out achromatic condenser (N.A. 0.9), for 1.25x-100x (swing-out: 1.25x-4x) Achromatic aplanatic condenser (N.A. 1.4), for 10x-100x Phase contrast, darkfield condenser (N.A. 1.1), [phase contrast: for 10x-100 x, darkfield: for 10x-100x (up to N.A. 0.80)] Universal condenser (N.A. 0.9), for 1.25x-100x [swing-out: 1.25x-4x, with oil top lens: (N.A. 1.4)] Low-magnification condenser (N.A. 0.75), for 2x-100x (Dry) Ultra low-magnification condenser (N.A. 0.16), for 1.25x-4x Darkfield dry condenser (N.A. 0.8-0.92), for 10x-100x Darkfield oil condenser (N.A. 1.20-1.40), for 10x-100x Motorised universal condenser (N.A. 0.9, motorised 8-position turret, aperture stop, polarising filter in/out mechanism and top lens swing out mechanism), for 1.25x-100x [swing-out 1.25x-4x, with oil top lens: (N.A. 1.4)]	Built-in condenser (N.A. 0.9) 1.25x-100x (swing out: 1.25x-2x)
<b>Fluorescence illuminator</b>		
	Manual reflected fluorescence, 8-position mirror turret unit, encoded with tool-free exchange of filter cubes Motorised reflected fluorescence, 8-position mirror turret unit, encoded with tool-free exchange of filter cubes	
<b>Fluorescence light source</b>		
	100 W Hg APO lamp housing and transformer 100 W Hg lamp housing and transformer 75 W Xe lamp housing and transformer Fibre-coupled metal halide light sources Fibre-coupled LED light source	
<b>Controller</b>		
	Optional: control box for semi-motorised set-ups	
<b>Operating environment</b>		
	Indoor use Ambient temperature: 5 °C to 40 °C (41 °F to 104 °F) Maximum relative humidity: 80% for temperatures up to 31 °C (88 °F), decreasing linearly through 70% at 34 °C (93 °F), 60% at 37 °C (99 °F), to 50% relative humidity at 40 °C (104 °F) Supply voltage fluctuations: not to exceed ±10% of the normal voltage	Indoor use Ambient temperature: 5 °C to 40 °C (41 °F to 104 °F) Maximum relative humidity: 80% for temperatures up to 31 °C (88 °F), decreasing linearly through 70% at 34 °C (93 °F), 60% at 37 °C (99 °F), to 50% relative humidity at 40 °C (104 °F) Supply voltage fluctuations: Not to exceed ±10% of the normal voltage



**BX46 system chart**

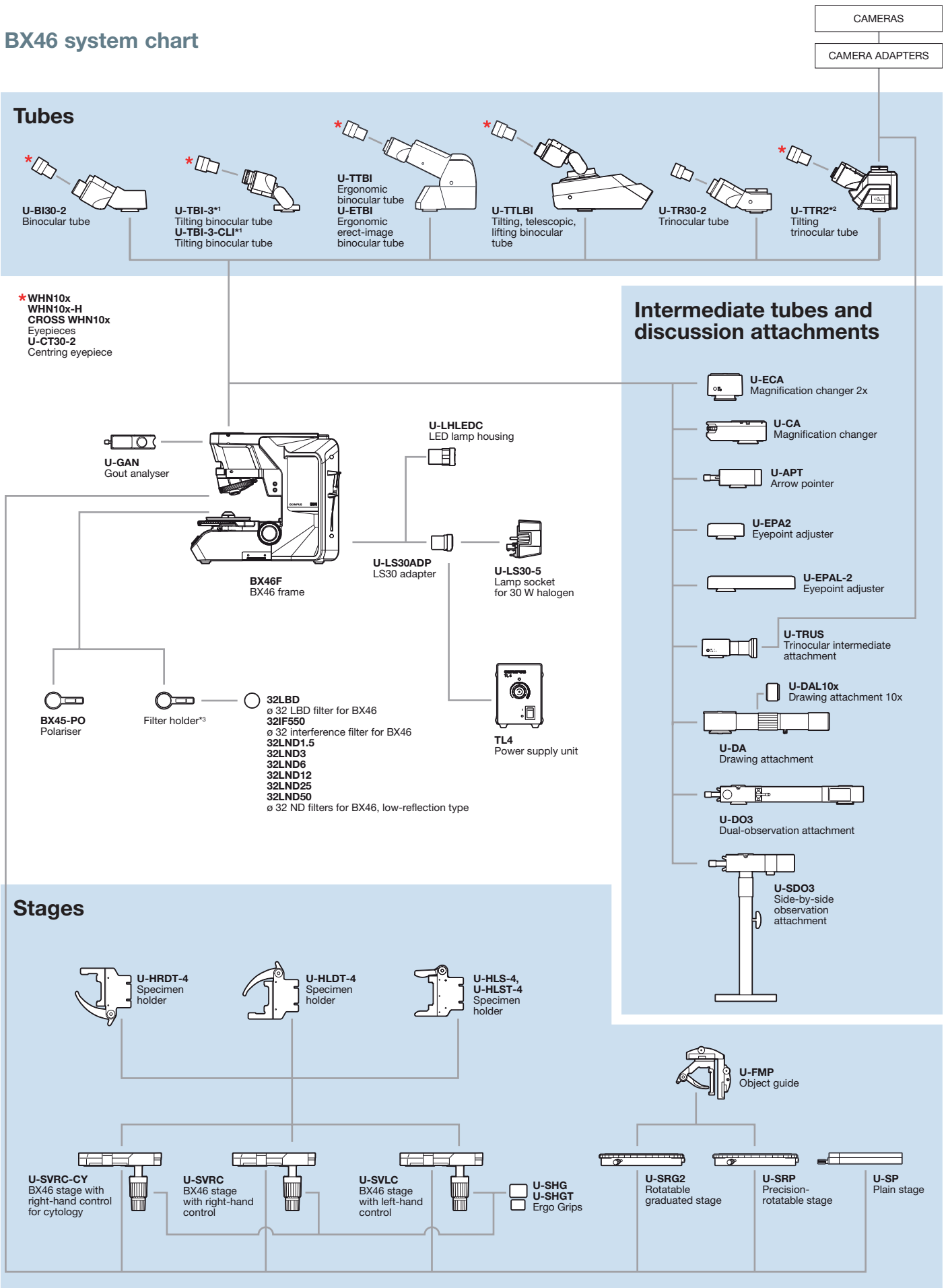

\*<sup>1</sup> Slight vignetting may occur in combination with an additional intermediate attachment. \*<sup>2</sup> Only U-EPA-2 or U-EPAL-2 can be used as an additional intermediate attachment.  
<sup>3</sup> Part of BX46F.

# BX43 system chart

- \* WHN10X, WHN10X-H, CROSS WHN10X  
Eyepieces  
U-CT30-2  
Centring telescope
- ▲ SWH10X-H, CROSS SWH10X, MICRO SWH10X  
Eyepieces  
U-CT30-2  
Centring telescope

## TV-adapters

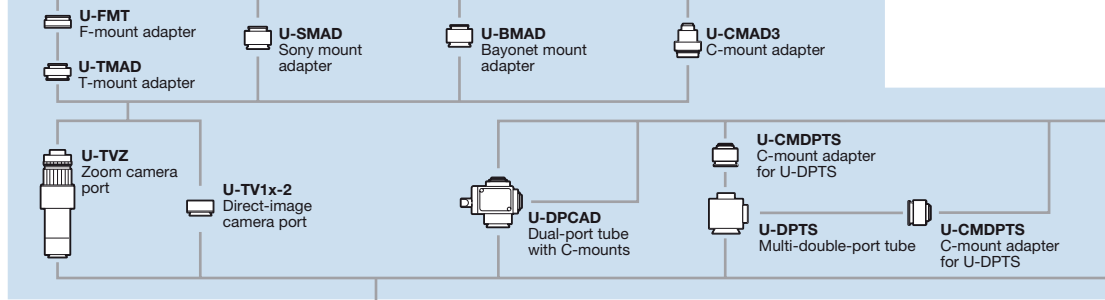

## Tubes

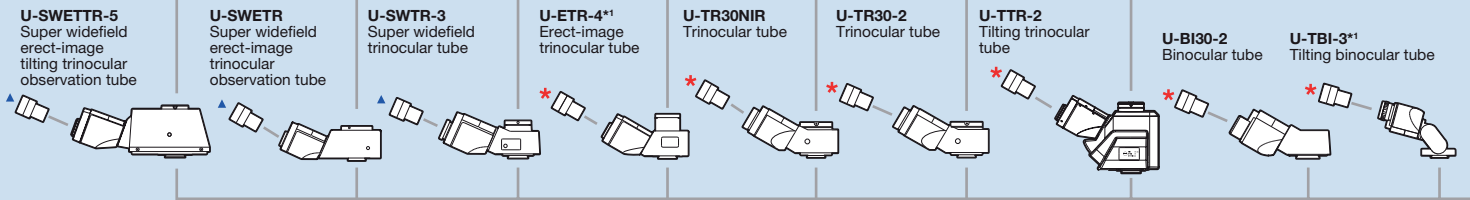

## Nosepieces and inserts

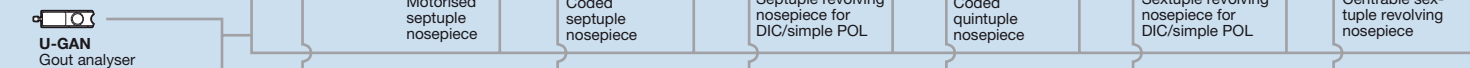

## Fluorescence illumination

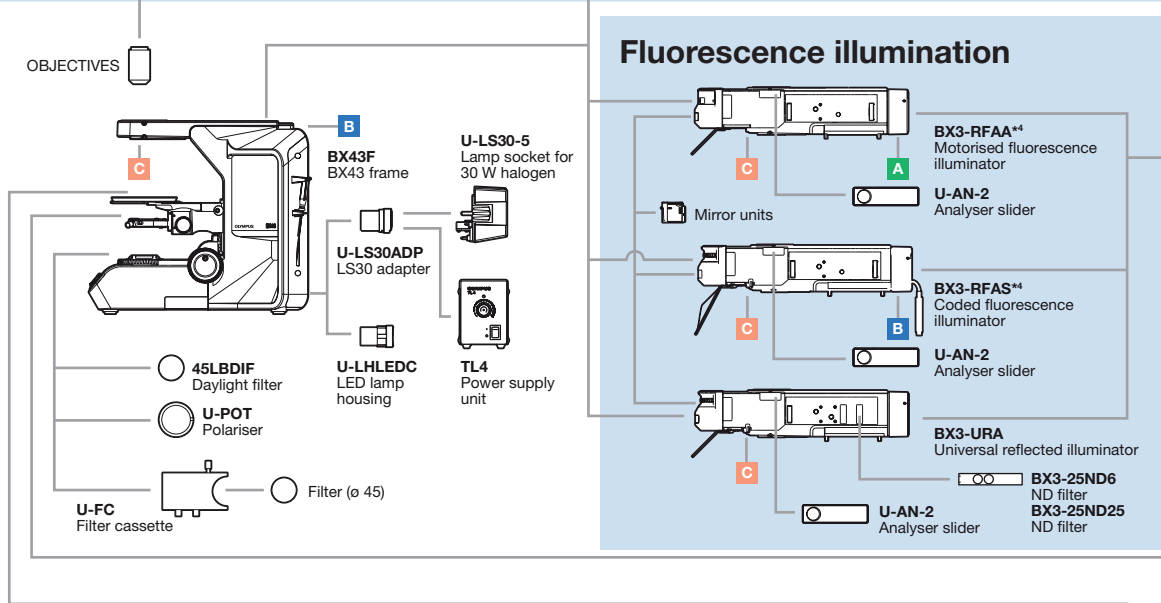

## Stages

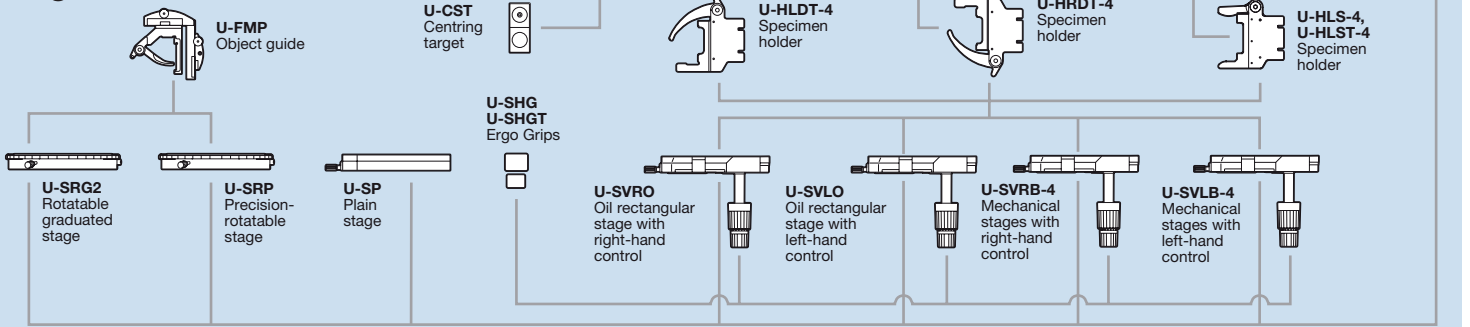

\*1 Slight vignetting may occur in combination with an additional intermediate attachment or observation method. \*2 Requires an additional intermediate attachment or fluorescence illuminator when used with BX43. \*3 Cannot be used with U-TTLBI. \*4 Compatible with FN 22. \*5 Cannot be used with BX3-URA. \*6 Stand supplied as standard with U-MDOSV and U-MDO10R3. \*7 An auxiliary lens is supplied.

CAMERAS

- U-TV0.25xC**  
C-mount camera port with 0.25x lens
- U-TV0.35xC-2**  
C-mount camera port with 0.35x lens
- U-TV0.5xC-3**  
C-mount camera port with 0.5x lens
- U-TV0.63xC-3**  
C-mount camera port with 0.63x lens
- U-TV1xC**  
C-mount camera adapter

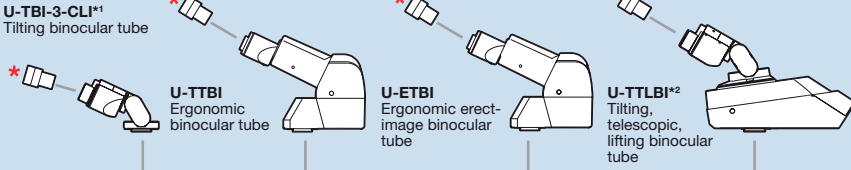

- U-P4RE**  
Centrable revolving nosepiece
- U-5RE-2**  
Quintuple revolving nosepiece

C

- U-LH75XEAP0**  
75 W xenon APO lamphouse
- U-LH100HGAPO**  
100 W mercury APO lamphouse
- U-LH100HG**  
100 W mercury lamphouse
- U-RX-T**  
Power source for 75 W xenon lamp
- U-RFL-T**  
Power source for 100 W mercury lamp

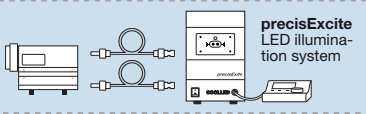
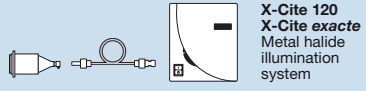

- U-HEAD\*5**  
Extension adapter for lamphouses
- U-DULHA**  
Double lamphouse adapter
- U-AW**  
Motorised attenuator wheel

A

Condensers

- U-LC\*7**  
Low-magnification condenser
- U-AC2**  
Abbe condenser
- U-SC3**  
Swing-out condenser
- U-AAC**  
Achromatic/aplanatic condenser
- U-ULC-2**  
Ultra low-magnification condenser
- U-PCD2**  
Phase/darkfield condenser
- U-POC-2**  
Polarising condenser

Optical devices

- U-CO1.25x**  
Low-magnification conversion lens
- U-UCDTP530**  
Tint plate for sensitive colour observation
- BX3-UCD8A**  
Motorised universal condenser
- U-UCD8-2**  
8-position universal condenser
- U-TLO**  
Oil top lens
- U-TLD**  
Dry top lens
- U-DCD**  
Darkfield condenser, dry
- U-DCW**  
Darkfield condenser, oil

A

Intermediate tubes and discussion attachments

- U-ECA**  
Magnification changer 2x
- U-ECA1.6x**  
Magnification changer 1.6x
- U-ANT**  
Analyser for transmitted light
- U-KPA**  
Intermediate attachment for simple polarising observation
- U-CA**  
Magnification changer
- U-DP\*1x3**  
Dual port
- U-DP1xC**  
Dual port 1x
- U-APT**  
Arrow pointer
- U-EPA2**  
Eyepoint adjuster
- U-EPAL-2**  
Eyepoint adjuster
- U-TRU\*1x3**  
Trinocular intermediate attachment
- U-TRUS\*1**  
Trinocular intermediate attachment
- U-CPA**  
Intermediate attachment for conoscopic and orthoscopic observation
- U-OPA**  
Intermediate attachment for orthoscopic observation
- U-AN360P-2**  
Rotatable analyser

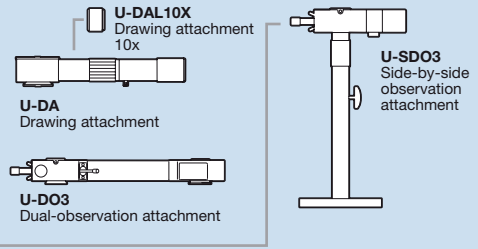

Multi-observation set-ups for more than two persons require BX53 with 100 W halogen illumination

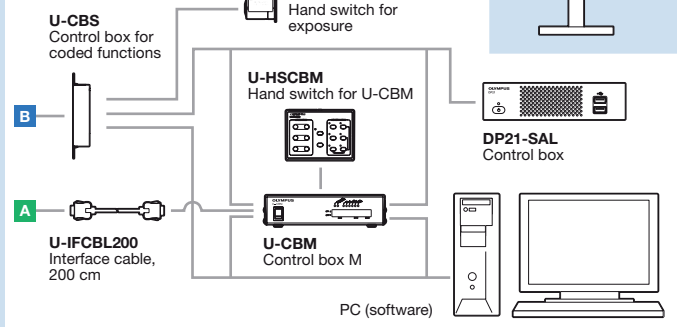
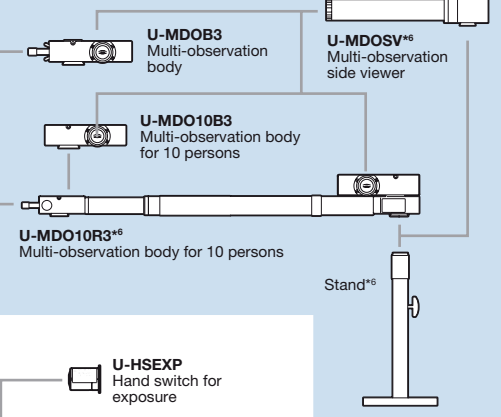

# Dimensions

## BX43 dimensions

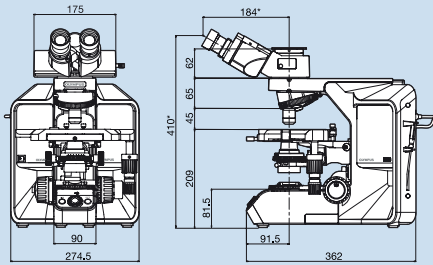

## BX46 dimensions

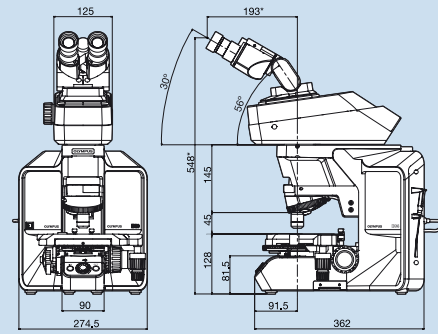

## BX53 MDO dimensions

